

ELECTRONIC WARFARE FUNDAMENTALS

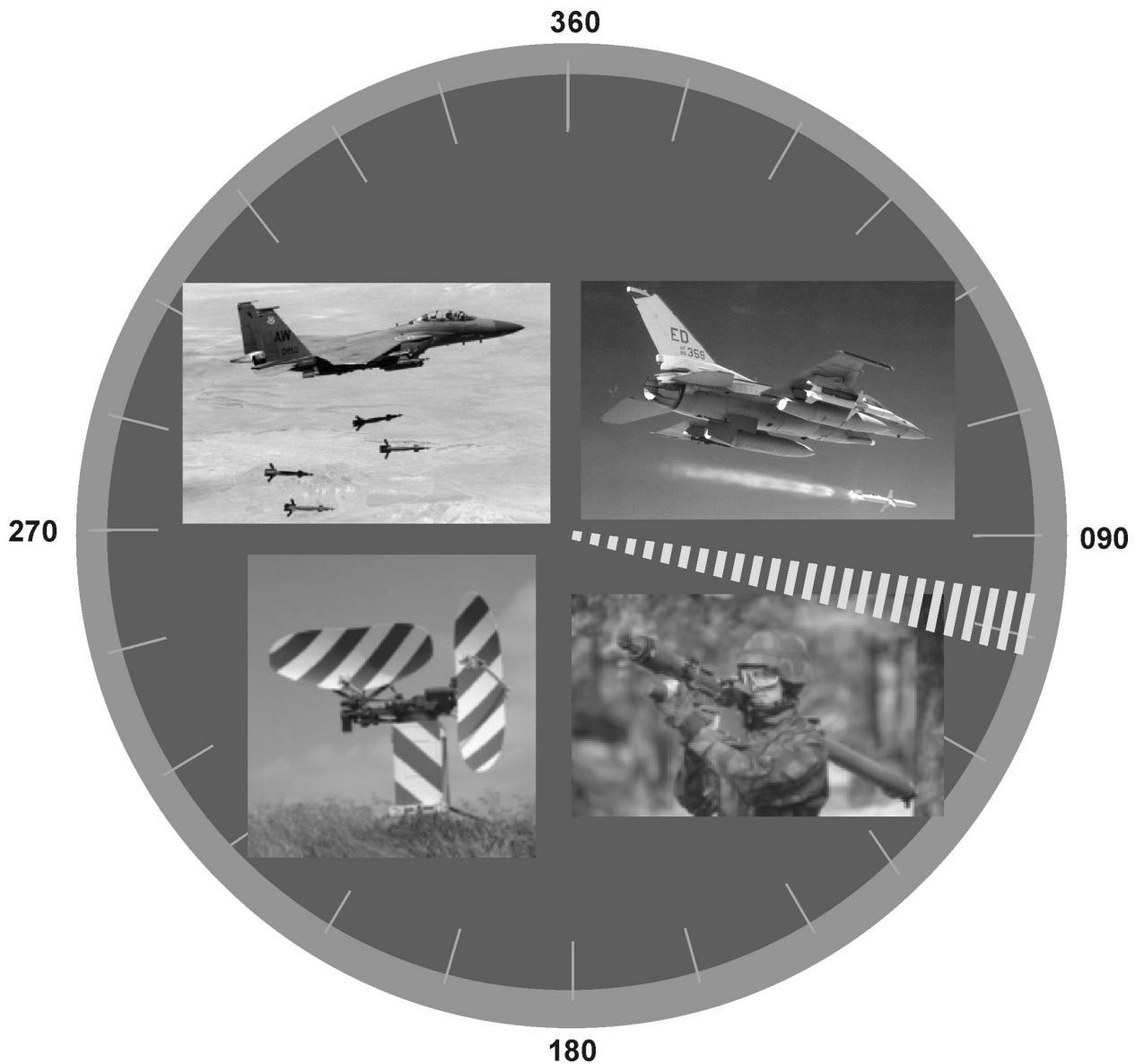

NOVEMBER 2000

PREFACE

Electronic Warfare Fundamentals is a student supplementary text and reference book that provides the foundation for understanding the basic concepts underlying electronic warfare (EW). This text uses a practical building-block approach to facilitate student comprehension of the essential subject matter associated with the combat applications of EW.

Since radar and infrared (IR) weapons systems present the greatest threat to air operations on today's battlefield, this text emphasizes radar and IR theory and countermeasures. Although command and control (C²) systems play a vital role in modern warfare, these systems are not a direct threat to the aircrew and hence are not discussed in this book. This text does address the specific types of radar systems most likely to be associated with a modern integrated air defense system (IADS).

To introduce the reader to EW, *Electronic Warfare Fundamentals* begins with a brief history of radar, an overview of radar capabilities, and a brief introduction to the threat systems associated with a typical IADS. The two subsequent chapters introduce the theory and characteristics of radio frequency (RF) energy as it relates to radar operations. These are followed by radar signal characteristics, radar system components, and radar target discrimination capabilities. The book continues with a discussion of antenna types and scans, target tracking, and missile guidance techniques.

The next step in the building-block approach is a detailed description of countermeasures designed to defeat radar systems. The text presents the theory and employment considerations for both noise and deception jamming techniques and their impact on radar systems. This is followed by a chapter on decoys, both for defeating an IADS as well as for self-protection. Then, the next chapter discusses chaff characteristics, employment, and impact on specific radar systems.

The following two chapters are dedicated to the IR threat. The first covers IR theory, IR target detection and tracking, and advanced IR missile flare rejection techniques. The second chapter presents IR countermeasures to include flare employment, maneuvers, and missile warning equipment.

Electronic Warfare Fundamentals then addresses an important aspect of EW, specifically electronic protection (EP). This section includes a description of the most common radar EP techniques designed to counter noise jamming, deception jamming, and chaff employment. The book concludes with an overview of the basic components and limitations of a typical radar warning receiver (RWR), current geolocation techniques, and it finally discusses the basic components of a self-protection jamming system.

In addition to the textual material, the book also contains a detailed glossary of EW-related terms and acronyms for quick reference. A list of references is provided to acknowledge the source material used in the preparation of this text. These sources also provide the interested student with a supplementary reading list to learn more about a specific topic.

For information or comments on this document, please contact:

**Det 8, ACC TRSS
4349 Duffer Drive, Ste 437
Nellis AFB NV 89191-7007**

**DSN: 682-4897
DSN FAX: 682-7391
Comm: (702) 652-4897
Comm FAX: (702) 652-7391**

TABLE OF CONTENTS

CHAPTER 1. INTRODUCTION TO RADAR	1-1
1. INTRODUCTION	1-1
2. HISTORY	1-1
3. TARGET DISCRIMINANTS	1-2
4. INTRODUCTION TO INTEGRATED AIR DEFENSE SYSTEMS (IADS).....	1-6
5. SUMMARY.....	1-10
CHAPTER 2. CHARACTERISTICS OF RF RADIATION	2-1
1. INTRODUCTION	2-1
2. FREQUENCY	2-1
3. WAVELENGTH	2-2
4. POLARIZATION	2-2
5. DOPPLER EFFECT	2-5
6. ELECTROMAGNETIC SPECTRUM	2-7
7. RF PROPAGATION	2-9
8. SUMMARY	2-14
CHAPTER 3. RADAR SIGNAL CHARACTERISTICS	3-1
1. INTRODUCTION	3-1
2. PULSE WIDTH (PW)	3-1
3. PULSE RECURRENCE TIME (PRT)	3-1
4. PULSE REPETITION FREQUENCY (PRF)	3-2
5. RADAR RECEIVER CHARACTERISTICS	3-3
6. DUTY CYCLE	3-4
7. PEAK POWER.....	3-4
8. AVERAGE POWER	3-5
9. MODULATION	3-6
10. SUMMARY	3-8
CHAPTER 4. RADAR SYSTEM COMPONENTS	4-1
1. INTRODUCTION	4-1
2. PULSE RADAR SYSTEM	4-1
3. CONTINUOUS WAVE (CW) RADAR	4-7
4. PULSE DOPPLER RADAR	4-9
5. MONOPULSE RADAR	4-10
6. SUMMARY	4-13

CHAPTER 5. RADAR PRINCIPLES.....	5-1
1. INTRODUCTION.....	5-1
2. RADAR RANGE	5-1
3. AZIMUTH DETERMINATION	5-7
4. ELEVATION DETERMINATION.....	5-11
5. RADAR RESOLUTION CELL	5-12
6. PULSE DOPPLER VELOCITY DETERMINATION	5-14
7. BASIC RADAR EQUATION	5-18
8. SUMMARY	5-21
CHAPTER 6. ANTENNA CHARACTERISTICS AND SCANS	6-1
1. INTRODUCTION.....	6-1
2. PARABOLIC ANTENNA	6-1
3. CASSEGRAIN ANTENNA.....	6-3
4. PHASED ARRAY ANTENNA.....	6-5
5. ANTENNA GAIN.....	6-9
6. POWER DENSITY	6-11
7. CIRCULAR SCAN	6-12
8. LINEAR SCAN.....	6-16
9. UNIDIRECTIONAL SCAN	6-16
10. BIDIRECTIONAL SCAN.....	6-17
11. CONICAL SCAN.....	6-18
12. TRACK-WHILE-SCAN	6-20
13. IMPACT OF TERRAIN ON RADAR SCANS.....	6-23
14. SUMMARY.....	6-26
CHAPTER 7. TARGET TRACKING.....	7-1
1. INTRODUCTION.....	7-1
2. RANGE TRACKING	7-2
3. CONICAL SCAN.....	7-4
4. TRACK-WHILE-SCAN (TWS).....	7-6
5. LOBE-ON-RECEIVE-ONLY (LORO).....	7-11
6. MONOPULSE RADAR	7-12
7. CONTINUOUS WAVE (CW) RADARS.....	7-16
8. PULSE DOPPLER RADAR.....	7-20
9. SUMMARY	7-24
CHAPTER 8. RADAR MISSILE GUIDANCE TECHNIQUES.....	8-1
1. INTRODUCTION.....	8-1
2. COMMAND GUIDANCE	8-3
3. SEMI-ACTIVE GUIDANCE	8-6
4. ACTIVE GUIDANCE.....	8-9
5. SEEKER-AIDED GROUND GUIDANCE/TRACK-VIA-MISSILE GUIDANCE...8-11	

6. ANTI-AIRCRAFT ARTILLERY (AAA).....	8-12
7. SUMMARY.....	8-15
CHAPTER 9. INTRODUCTION TO RADAR JAMMING	9-1
1. INTRODUCTION.....	9-1
2. RADAR JAMMING TYPES.....	9-1
3. RADAR JAMMING EMPLOYMENT OPTIONS	9-3
4. FUNDAMENTALS OF RADAR JAMMING.....	9-7
5. SUMMARY.....	9-15
CHAPTER 10. RADAR NOISE JAMMING.....	10-1
1. INTRODUCTION.....	10-1
2. RADAR NOISE JAMMING EFFECTIVENESS.....	10-1
3. RADAR NOISE JAMMING GENERATION.....	10-4
4. BARRAGE JAMMING	10-5
5. SPOT JAMMING.....	10-6
6. SWEEP-SPOT JAMMING.....	10-7
7. COVER PULSE JAMMING.....	10-8
8. MODULATED NOISE JAMMING	10-10
9. SUMMARY.....	10-11
CHAPTER 11. DECEPTION JAMMING.....	11-1
1. INTRODUCTION.....	11-1
2. FALSE TARGET JAMMING	11-3
3. RANGE DECEPTION JAMMING.....	11-5
4. ANGLE DECEPTION JAMMING	11-8
5. VELOCITY DECEPTION JAMMING.....	11-11
6. MONOPULSE DECEPTION JAMMING.....	11-17
7. TERRAIN BOUNCE.....	11-23
8. SUMMARY.....	11-24
CHAPTER 12. DECOYS	12-1
1. INTRODUCTION.....	12-1
2. SATURATION DECOYS.....	12-1
3. TOWED DECOYS.....	12-3
4. EXPENDABLE ACTIVE DECOYS.....	12-6
5. SUMMARY.....	12-7
CHAPTER 13. CHAFF EMPLOYMENT	13-1
1. INTRODUCTION.....	13-1
2. CHAFF CHARACTERISTICS.....	13-2
3. CHAFF OPERATIONAL EMPLOYMENT	13-9
4. SUMMARY.....	13-16

CHAPTER 14. IR FUNDAMENTALS	14-1
1. INTRODUCTION.....	14-1
2. BASIC IR THEORY	14-1
3. IR SIGNATURE SOURCES.....	14-5
4. IR SEEKER CHARACTERISTICS.....	14-7
5. IR SEEKER TYPES.....	14-9
6. IR MISSILE FLARE REJECTION.....	14-12
7. SUMMARY	14-18
CHAPTER 15. IR COUNTERMEASURES.....	15-1
1. INTRODUCTION.....	15-1
2. FLARE CHARACTERISTICS	15-1
3. ADVANCED FLARES	15-3
4. FLARE EMPLOYMENT.....	15-4
5. IRCM TACTICS	15-5
6. MISSILE APPROACH WARNING SYSTEMS (MAWS).....	15-6
7. SUMMARY	15-8
CHAPTER 16. RADAR ELECTRONIC PROTECTION (EP) TECHNIQUES	16-1
1. INTRODUCTION.....	16-1
2. RADAR RECEIVER PROTECTION	16-1
3. JAMMING SIGNAL AVOIDANCE	16-4
4. JAMMING SIGNAL EXPLOITATION	16-5
5. OVERPOWERING THE JAMMING SIGNAL.....	16-6
6. PULSE DURATION DISCRIMINATION	16-7
7. ANGLE DISCRIMINATION.....	16-7
8. BANDWIDTH DISCRIMINATION	16-8
9. DOPPLER DISCRIMINATION	16-9
10. TIME DISCRIMINATION.....	16-9
11. SUMMARY.....	16-10
CHAPTER 17. RADAR WARNING RECEIVER (RWR) BASIC OPERATIONS AND GEOLOCATION TECHNIQUES	17-1
1. INTRODUCTION.....	17-1
2. RWR ANTENNAS.....	17-1
3. RWR RECEIVER/AMPLIFIERS.....	17-3
4. SIGNAL PROCESSOR.....	17-6
5. EMITTER IDENTIFICATION (EID) TABLES	17-8
6. RWR SCOPE DISPLAY	17-8
7. RWR AUDIO.....	17-9
8. RWR INTERFACE CONTROL UNIT (ICU)	17-10
9. RWR LIMITATIONS.....	17-10
10. THREAT GEOLOCATION TECHNIQUES	17-15
11. SUMMARY.....	17-20

CHAPTER 18. SELF-PROTECTION JAMMING SYSTEM OPERATIONS..... 18-1

- 1. INTRODUCTION..... 18-1**
- 2. RECEIVE ANTENNAS..... 18-2**
- 3. RECEIVER SECTION 18-2**
- 4. SYSTEM PROCESSOR..... 18-3**
- 5. JAMMING TECHNIQUES GENERATOR 18-4**
- 6. TRANSMIT ANTENNAS..... 18-4**
- 7. C-9492 CONTROL INDICATOR UNIT..... 18-5**
- 8. JAMMING POD CONSIDERATIONS 18-5**
- 9. SUMMARY..... 18-7**

ANNEX A. GLOSSARY.....A-1

ANNEX B. EC-RELATED ABBREVIATIONS AND ACRONYMS.....B-1

LIST OF REFERENCES

LIST OF FIGURES

Figure 1-1. Radar System.....	1-1
Figure 1-2. Early Continuous Wave Radar Experiments	1-1
Figure 1-3. Pulse Radar Operation.....	1-2
Figure 1-4. Radar Advantages and Disadvantages	1-3
Figure 1-5. Radar Target Discriminants.....	1-3
Figure 1-6. Angle Discrimination.....	1-4
Figure 1-7. Velocity Discrimination.....	1-5
Figure 1-8. Basic Radar Operation.....	1-5
Figure 1-9. Early Warning Radar System.....	1-6
Figure 1-10. GCI Radar	1-7
Figure 1-11. Acquisition Radar and TTR.....	1-8
Figure 1-12. TTR with Acquisition	1-8
Figure 1-13. MiG-29	1-9
Figure 1-14. IR System	1-9
Figure 1-15. A Typical IADS	1-10
Figure 2-1. Radio Frequency	2-1
Figure 2-2. Radar Signal Wavelength.....	2-2
Figure 2-3. Radar Signal Vertical Polarization	2-3
Figure 2-4. Circular Polarization.....	2-4
Figure 2-5. Impact of Polarization	2-4
Figure 2-6. Zero Doppler Effect – Stationary Target.....	2-6
Figure 2-7. Doppler Effect – Closing Target.....	2-6
Figure 2-8. Doppler Effect – Opening Target.....	2-6
Figure 2-9. Electromagnetic Spectrum	2-7
Figure 2-10. Impact of Refraction on RF Propagation.....	2-10
Figure 2-11. Impact of Refraction on Target Elevation Determination.....	2-10
Figure 2-12. Superrefracting Surface Duct.....	2-12
Figure 2-13. RF Atmospheric Attenuation	2-14
Figure 3-1. Typical Radar Pulse	3-1
Figure 3-2. Constant PRF Radar Pulse	3-2
Figure 3-3. PRF Stagger	3-2
Figure 3-4. PRF Jitter.....	3-3
Figure 3-5. Basic Radar Pulse	3-3
Figure 3-6. Peak Power and Average Power	3-5
Figure 3-7. Radar Power and Energy	3-6
Figure 3-8. Amplitude Modulation.....	3-6
Figure 3-9. Frequency Modulation	3-7
Figure 3-10. Pulse Modulation.....	3-7
Figure 4-1. Pulse Radar Block Diagram.....	4-1
Figure 4-2. Transmitter Group.....	4-2
Figure 4-3. Receiver Group.....	4-3
Figure 4-4. Master Timer/Synchronizer.....	4-4
Figure 4-5. Parabolic Antenna	4-4

Figure 4-6. A Scope Display.....	4-5
Figure 4-7. B Scope Display.....	4-5
Figure 4-8. RHI Scope Display	4-6
Figure 4-9. PPI Scope Display.....	4-6
Figure 4-10. Continuous Wave Radar	4-7
Figure 4-11. Basic CW Doppler Radar.....	4-8
Figure 4-12. CW Doppler Radar Display	4-8
Figure 4-13. CW and Pulse Doppler Radar Comparison	4-9
Figure 4-14. Basic Pulse Doppler Radar Diagram.....	4-10
Figure 4-15. Monopulse Radar.....	4-11
Figure 4-16. Monopulse Magic T's.....	4-11
Figure 4-17. Magic T Output Signals	4-12
Figure 4-18. Monopulse Radar Track	4-12
Figure 4-19. Monopulse Radar Track Logic.....	4-13
Figure 5-1. Basic Radar Pulse	5-1
Figure 5-2. Radar Mile.....	5-2
Figure 5-3. Second Time Around Echo	5-3
Figure 5-4. Radar Pulse	5-4
Figure 5-5. Radar Pulse at T1.....	5-5
Figure 5-6. Radar Pulse at T2.....	5-5
Figure 5-7. Radar Pulse at T3.....	5-6
Figure 5-8. Radar Range Resolution	5-6
Figure 5-9. Radar Beamwidth	5-7
Figure 5-10. Azimuth Determination.....	5-8
Figure 5-11. Antenna Scan.....	5-8
Figure 5-12. Horizontal Beamwidth Comparison	5-9
Figure 5-13. Horizontal Beamwidth and Azimuth Resolution	5-10
Figure 5-14. Azimuth Resolution	5-10
Figure 5-15. Vertical Beamwidth and Elevation Resolution	5-11
Figure 5-16. Elevation Resolution	5-12
Figure 5-17. Radar Resolution Cell.....	5-13
Figure 5-18. Radar Resolution Cell Dimensions	5-13
Figure 5-19. Pulse Modulation	5-14
Figure 5-20. Harmonics of a Pulse Modulated Waveform	5-15
Figure 5-21. Harmonic Content.....	5-15
Figure 5-22. Spectral Line Frequencies	5-16
Figure 5-23. Selective Clutter Canceling.....	5-16
Figure 5-24. PRF and Spectral Lines.....	5-17
Figure 5-25. Pulse Doppler Filters	5-18
Figure 6-1. Parabolic Antenna	6-1
Figure 6-2. Parabolic Cylinder Antenna	6-2
Figure 6-3. Height-Finder Parabolic Antenna	6-3
Figure 6-4. Multiple-Feed Parabolic Antenna	6-3
Figure 6-5. Cassegrain Antenna	6-4
Figure 6-6. Flat Plate Cassegrain Antenna	6-4
Figure 6-7. Phased Array Antenna	6-5

Figure 6-8. Phase Relationships	6-6
Figure 6-9. Broadside Array.....	6-7
Figure 6-10. End-Fire Array.....	6-7
Figure 6-11. Phased Array Antenna Scan.....	6-8
Figure 6-12. Planar Array Antenna.....	6-9
Figure 6-13. Radiation Pattern for a Parabolic Antenna.....	6-11
Figure 6-14. Radar Antenna Pattern.....	6-12
Figure 6-15. Circular Scan Radar	6-13
Figure 6-16. PPI Scope Display	6-14
Figure 6-17. Resolution Cell	6-14
Figure 6-18. V-Beam Radar	6-15
Figure 6-19. Stacked Beam Radar.....	6-15
Figure 6-20. Unidirectional Linear Scan	6-16
Figure 6-21. Helical Scan	6-17
Figure 6-22. Raster Scan.....	6-17
Figure 6-23. Conical Scan.....	6-18
Figure 6-24. Conical Scan Tracking Area	6-18
Figure 6-25. Palmer-Raster Scan.....	6-19
Figure 6-26. Palmer-Helical Scan	6-20
Figure 6-27. Conventional TWS Radar.....	6-21
Figure 6-28. Phased Array Antenna	6-21
Figure 6-29. Phased Array TWS	6-22
Figure 6-30. Phased Array TWS Radar Display.....	6-23
Figure 6-31. The Radar Horizon.....	6-23
Figure 6-32. Direct Terrain Masking.....	6-25
Figure 6-33. Indirect Terrain Masking	6-26
Figure 7-1. Split-Gate Range Tracker.....	7-2
Figure 7-2. Leading-Edge Range Tracker.....	7-3
Figure 7-3. Conical Scan Positions	7-4
Figure 7-4. Conical Scan Modulation.....	7-5
Figure 7-5. Conical Scan Tracking Errors	7-5
Figure 7-6. Conical Scan Tracking	7-6
Figure 7-7. Conventional TWS Radar Beams	7-7
Figure 7-8. Conventional TWS Azimuth Tracking.....	7-8
Figure 7-9. Phased Array TWS	7-9
Figure 7-10. Air-to-Air TWS Display	7-10
Figure 7-11. Planar/Phased Array TWS Tracking Loop.....	7-10
Figure 7-12. LORO Mode.....	7-11
Figure 7-13. Monopulse Magic T	7-13
Figure 7-14. Magic T Output Signals.....	7-13
Figure 7-15. Monopulse Tracking Loops	7-14
Figure 7-16. Monopulse Elevation Tracking Error	7-15
Figure 7-17. Monopulse Elevation Track	7-15
Figure 7-18. Monopulse Azimuth Track.....	7-16
Figure 7-19. CW Radar	7-16
Figure 7-20. FM CW Radar Range Determination (No Relative Motion).....	7-18

Figure 7-21. FM CW Radar Range Determination (Relative Motion).....	7-18
Figure 7-22. Comparison of CW Radar and Pulse Doppler Radar.....	7-20
Figure 7-23. Range Ambiguity	7-21
Figure 7-24. Pulse Doppler Speed Gate.....	7-22
Figure 7-25. Range Ambiguity	7-23
Figure 7-26. Range Eclipsing.....	7-23
Figure 7-27. Resolving Range Ambiguity and Eclipsing.....	7-24
Figure 8-1. Initial Boost Phase.....	8-1
Figure 8-2. Mid-Course Guidance Phase	8-2
Figure 8-3. Terminal Guidance Phase.....	8-3
Figure 8-4. Rectified Flight Profile.....	8-4
Figure 8-5. Command Guidance: Three-Point Pursuit.....	8-5
Figure 8-6. Semi-Active Guided Missile	8-6
Figure 8-7. Semi-Active Guidance (Mid-Course).....	8-7
Figure 8-8. Semi-Active Guidance (Terminal Phase)	8-8
Figure 8-9. Semi-Active Guidance CW Reference Signal	8-9
Figure 8-10. Active Guidance Mid-Course Intercept Phase	8-9
Figure 8-11. Active Guidance Phase	8-10
Figure 8-12. SAGG/Track-Via-Missile Guidance.....	8-11
Figure 8-13. Optically Aimed AAA.....	8-13
Figure 8-14. Radar-Directed AAA	8-14
Figure 8-15. Sector/Barrage AAA	8-15
Figure 9-1. Noise Jamming	9-1
Figure 9-2. Deception Jamming.....	9-2
Figure 9-3. Stand-Off Jamming.....	9-3
Figure 9-4. False Target Jamming.....	9-4
Figure 9-5. Escort Jamming.....	9-5
Figure 9-6. Escort Jamming Alignment	9-5
Figure 9-7. Self-Protection Jamming.....	9-6
Figure 9-8. Jamming Frequency Error	9-7
Figure 9-9. Correct Jamming Frequency Matching.....	9-8
Figure 9-10. S/N Ratio and Target Detection	9-11
Figure 9-11. Receiver False Alarm Threshold	9-11
Figure 9-12. S/N Ratio Greater Than One.....	9-12
Figure 9-13. S/N Ratio Less Than One	9-12
Figure 9-14. J/S Ratio Greater Than One	9-14
Figure 9-15. J/S Ratio Less Than One.....	9-14
Figure 9-16. Burnthrough Range.....	9-15
Figure 10-1. Noise Level in a Typical Radar Receiver Output.....	10-1
Figure 10-2. Impact of Noise Jamming	10-2
Figure 10-3. Power Density – Narrow Bandwidth.....	10-2
Figure 10-4. Power Density – Wide Bandwidth	10-3
Figure 10-5. Frequency Modulated (FM) Noise Jamming System	10-5
Figure 10-6. Barrage Jamming	10-6
Figure 10-7. Spot Jamming	10-6
Figure 10-8. Spot Jamming Effectiveness	10-7

Figure 10-9. Swept-Spot Jamming	10-8
Figure 10-10. Cover Pulse Jamming	10-8
Figure 10-11. Range Gate Pull-Off Cover Pulse	10-9
Figure 10-12. Velocity Gate Pull-Off Cover Pulse	10-10
Figure 10-13. Conical Scan Modulated Jamming	10-10
Figure 10-14. TWS Modulated Jamming	10-11
Figure 11-1. Deception Jamming System	11-2
Figure 11-2. False Target Generation.....	11-3
Figure 11-3. Range Gate Tracking.....	11-5
Figure 11-4. Range Gate Jamming Cover Pulse	11-6
Figure 11-5. Range Gate Pull-Off.....	11-7
Figure 11-6. Inverse Amplitude Modulation Jamming.....	11-8
Figure 11-7. Inverse Gain Jamming	11-9
Figure 11-8. Swept Square Wave Jamming.....	11-10
Figure 11-9. Velocity Tracking Gate.....	11-11
Figure 11-10. Velocity Gate Capture	11-12
Figure 11-11. Velocity Gate Pull-Off.....	11-13
Figure 11-12. Doppler Noise Jamming.....	11-14
Figure 11-13. Impact of Doppler Noise Jamming.....	11-14
Figure 11-14. Narrowband Doppler Noise	11-15
Figure 11-15. Velocity Bin Masking.....	11-16
Figure 11-16. Impact of Doppler False Target Jamming	11-17
Figure 11-17. Monopulse Radar Receiver.....	11-18
Figure 11-18. Filter Skirt Jamming Pulse.....	11-19
Figure 11-19. Ineffective Filter Skirt Jamming	11-19
Figure 11-20. Monopulse Image Frequency	11-20
Figure 11-21. Monopulse Image Jamming.....	11-21
Figure 11-22. Cross-Polarization Antenna Pattern	11-21
Figure 11-23. Cross-Eye Jamming	11-23
Figure 11-24. Terrain Bounce	11-24
Figure 12-1. Tactical Air Launched Decoy.....	12-2
Figure 12-2. Miniature Air Launched Decoy (MALD)	12-3
Figure 12-3. Towed Decoy	12-4
Figure 12-4. AN/ALE-50 System	12-5
Figure 12-5. Generic Expendable	12-6
Figure 13-1. "WINDOW" – The First Operational Employment of Chaff	13-1
Figure 13-2. Aircraft Radar Cross Section (RCS).....	13-2
Figure 13-3. RR-170 Chaff Cartridge RCS.....	13-3
Figure 13-4. Threat Radar Aspect and Chaff RCS	13-4
Figure 13-5. Impact of Multiple Chaff Cartridge Employment on Chaff RCS.....	13-4
Figure 13-6. Chaff Length and Frequency Coverage.....	13-5
Figure 13-7. RR-170 Chaff Cartridge	13-6
Figure 13-8. Impact of Turbulence and Chaff Bloom Rate	13-7
Figure 13-9. Chaff Bloom Rate and Radar Resolution Cell	13-7
Figure 13-10. Impact of Chaff Polarization	13-9
Figure 13-11. Area Saturation Tactics	13-10

Figure 13-12. Chaff Corridor Tactics	13-11
Figure 13-13. Self-Protection Chaff Tactics	13-12
Figure 13-14. Self-Protection Chaff Effect on a TWS Radar	13-13
Figure 13-15. Self-Protection Chaff Impact on a Conical Scan Radar	13-14
Figure 13-16. Self-Protection Chaff Impact on a Monopulse Radar	13-15
Figure 13-17. Self-Protection Chaff Impact on a Doppler Radar	13-16
Figure 14-1. The IR Threat	14-1
Figure 14-2. IR Frequency Band	14-2
Figure 14-3. Atmospheric IR Transmission	14-3
Figure 14-4. IR Missile Seeker	14-4
Figure 14-5. Aircraft IR Intensity	14-4
Figure 14-6. IR Signature Versus Aspect Angle	14-5
Figure 14-7. Target Signature Sources	14-6
Figure 14-8. IR Detection Materials	14-7
Figure 14-9. IR Missile Seeker	14-7
Figure 14-10. Spin Scan Reticle	14-8
Figure 14-11. Missile Field of View	14-9
Figure 14-12. IR Missile Reticle	14-10
Figure 14-13. Conical Scan IR Seeker	14-11
Figure 14-14. Impact of IR Missile Field of View	14-13
Figure 14-15. IR Missile – Narrow Field of View	14-13
Figure 14-16. Two-Color IR “Trigger”	14-15
Figure 14-17. Seeker Push-Ahead “Response” Technique	14-16
Figure 14-18. Seeker Push-Pull “Response” Technique	14-17
Figure 14-19. Sector Attenuation “Response” Technique	14-18
Figure 15-1. The MJU-7 Flare	15-1
Figure 15-2. Impact of Flare Rise Time	15-2
Figure 15-3. Kinematic Flare	15-3
Figure 15-4. Flare Visual Signature	15-4
Figure 15-5. Initial Maneuver and Flare Employment	15-5
Figure 15-6. IRCM	15-6
Figure 15-7. Missile Alert Warning System (MAWS)	15-7
Figure 17-1. Radar Warning Receiver (RWR) Antennas	17-2
Figure 17-2. RWR Antenna Sensitivity	17-2
Figure 17-3. RWR Antenna Polarization	17-3
Figure 17-4. Crystal Video RWR Receiver	17-4
Figure 17-5. Superheterodyne RWR Receiver	17-5
Figure 17-6. RWR System	17-6
Figure 17-7. Signal Processor Signal Priority	17-7
Figure 17-8. Sample EID Table	17-8
Figure 17-9. RWR Scope Azimuth Positioning	17-9
Figure 17-10. RWR Interface Control Unit	17-10
Figure 17-11. Signal Frequency Spectrum	17-11
Figure 17-12. RWR Threat Azimuth Position Determination	17-12
Figure 17-13. RWR Azimuth Error	17-13
Figure 17-14. RWR Multiple Threat Symbols	17-14

Figure 17-15. Triangulation.....	17-16
Figure 17-16. Interferometer Components	17-17
Figure 17-17. Interferometer Array	17-17
Figure 17-18. Time of Arrival Measurements	17-18
Figure 17-19. Time Difference of Arrival Measurements	17-19
Figure 18-1. ALQ-184 Pod	18-1
Figure 18-2. ALQ-184 Receive Antenna Location	18-2
Figure 18-3. ALQ-184 Simplified Block Diagram.....	18-3
Figure 18-4. ALQ-184 Transmit Antenna Location	18-4
Figure 18-5. C-9492 Control Indicator Unit	18-5
Figure 18-6. F-16 ECM CMS	18-6

LIST OF EQUATIONS

Equation 1-1. Basic Radar Range Equation	1-4
Equation 2-1. Basic Wavelength Equation	2-2
Equation 2-2. Index of Refraction	2-11
Equation 2-3. Refractivity of RF Waves (Normal Radar Frequencies).....	2-11
Equation 3-1. Duty Cycle.....	3-4
Equation 3-2. Energy Per Pulse	3-5
Equation 5-1. Basic Radar Range Determination Equation	5-2
Equation 5-2. Radar Mile	5-2
Equation 5-3. Maximum Unambiguous Range	5-4
Equation 5-4. Range Resolution	5-7
Equation 5-5. Azimuth Resolution.....	5-11
Equation 5-6. Altitude Resolution.....	5-12
Equation 5-7. Power Density From an Antenna	5-18
Equation 5-8. Power Density at the Target	5-19
Equation 5-9. Power Density at the Antenna	5-19
Equation 5-10. Signal Power Density	5-20
Equation 5-11. Basic Radar Equation	5-20
Equation 6-1. Directive Gain	6-9
Equation 6-2. Power Gain.....	6-10
Equation 6-3. Power Density for an Isotropic Antenna	6-10
Equation 6-4. Power Density for a Practical Antenna.....	6-10
Equation 6-5. Power Gain of a Practical Antenna	6-11
Equation 6-6. Basic Radar Horizon Equation	6-24
Equation 6-7. Simplified Radar Horizon Equation.....	6-24
Equation 6-8. Target LOS Distance	6-24
Equation 9-1. Signal Power Density	9-9
Equation 9-2. Thermal Noise.....	9-9
Equation 9-3. Signal-to-Noise Ratio	9-10
Equation 9-4. Jamming-to-Signal Ratio	9-13

LIST OF TABLES

Table 2-1. Antenna Polarization Loss	2-5
Table 2-2. Commonly Used Prefixes for Scientific Notation.....	2-8
Table 2-3. Radar Frequency Band Designations	2-9
Table 7-1. Pulse Doppler Tracking Capabilities	7-21
Table 17-1. RWR Frequency Band Designators	17-3

CHAPTER 1. INTRODUCTION TO RADAR

1. INTRODUCTION

The word “RADAR” is an acronym for Radio Detection And Ranging. As it was originally conceived, radio waves were used to detect the presence of a target and to determine its distance or range (Figure 1-1).

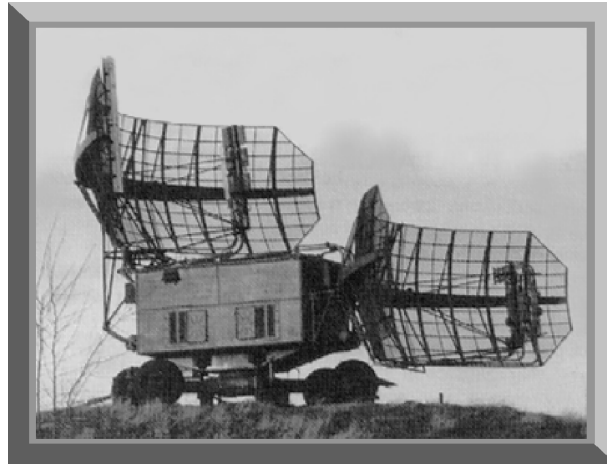

Figure 1-1. Radar System

2. HISTORY

The reflection of radio waves by objects was first noted more than a century ago. In 1903, the reflection of radio waves was employed in Germany to demonstrate detection of ships at sea (Figure 1-2). In 1922, Marconi presented the same idea in Britain but received little official interest. These early experiments used continuous wave, or CW, transmissions and relied on the reflection of a transmitted wave from a target to indicate the presence of a target. CW transmissions can detect the presence of an object and, if the radio wave is formed into a narrow beam, can also provide azimuth information. CW transmissions cannot provide range.

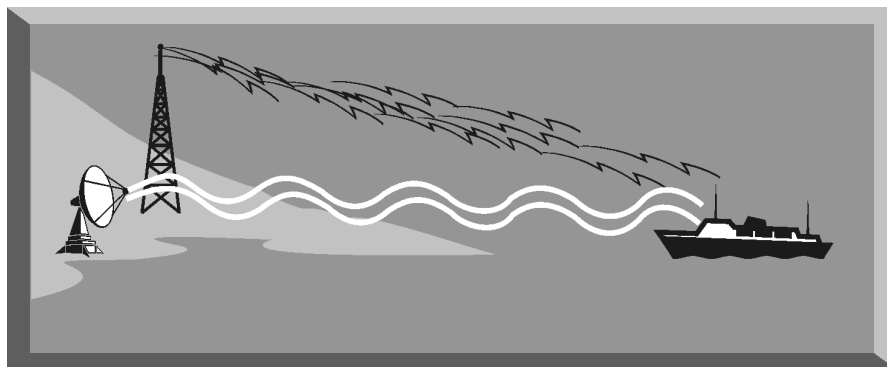

Figure 1-2. Early Continuous Wave Radar Experiments

a. The lack of range information was a serious limitation but was finally overcome by modulating the radio wave transmissions to send out a train of short pulses (Figure 1-3). The time between pulse transmission and an echo return to the receiver provides a direct measurement of range. Practical development of the pulse radar began in the 1930s, principally in the United States, Britain, and Germany. Due to deteriorating relations with Germany and the threat of invasion, the British intensified their efforts to develop a pulse radar in 1935. These efforts culminated in the development and deployment of multiple radar stations which formed the Chain Home System. These radar installations provided critical information to British pilots on the size and location of German bomber formations during the Battle of Britain.

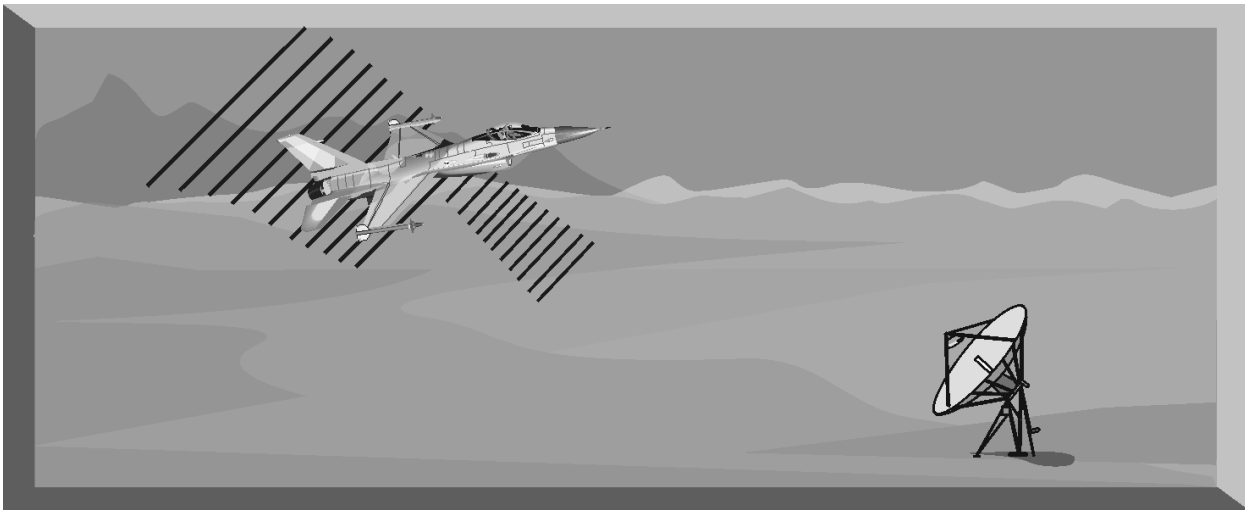

Figure 1-3. Pulse Radar Operation

b. The Chain Home System is considered the first integrated air defense system, or IADS. Radar development, with its obvious military and civilian applications, has continued unabated to the present day.

3. TARGET DISCRIMINANTS

The widespread military and civilian application of radar is based on its inherent advantages over the human eye (Figure 1-4). Radar can “see” farther than the human eye and more accurately assess the range or distance of an object. Radar works well in all-weather conditions and is relatively immune to smoke, haze, and clouds. What’s more, radar works 24 hours a day because it can transmit its own energy and does not have to rely on sunshine or ambient radiation. There are some disadvantages of radar when compared to the human eye. First, radar does not have the resolution that the human eye has. While radar can detect the presence of an airplane, the human eye can discern, in great detail, the shape, size, color, and even markings. This can be a serious limitation if positive identification is required prior to engagement.

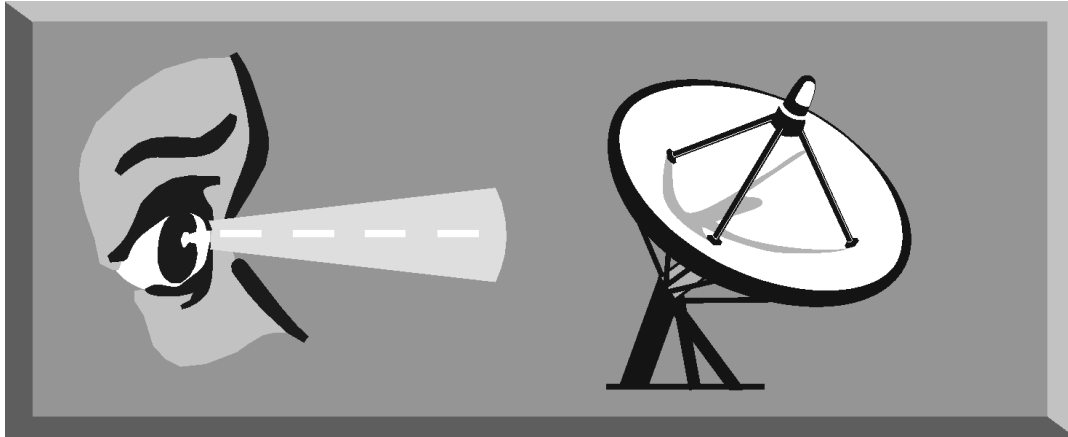

Figure 1-4. Radar Advantages and Disadvantages

Second, the human eye is not bothered by undesirable reflections, called clutter, the way radar sometimes is. Although metal is the best reflector of radio frequency (RF) energy, nearly any material will reflect some RF energy. Mountains, trees, buildings, rain, birds, and chaff all reflect RF energy. Radar systems must use target discriminants to isolate the desired target return from the clutter. These target discriminants include range, velocity, and angle (Figure 1-5).

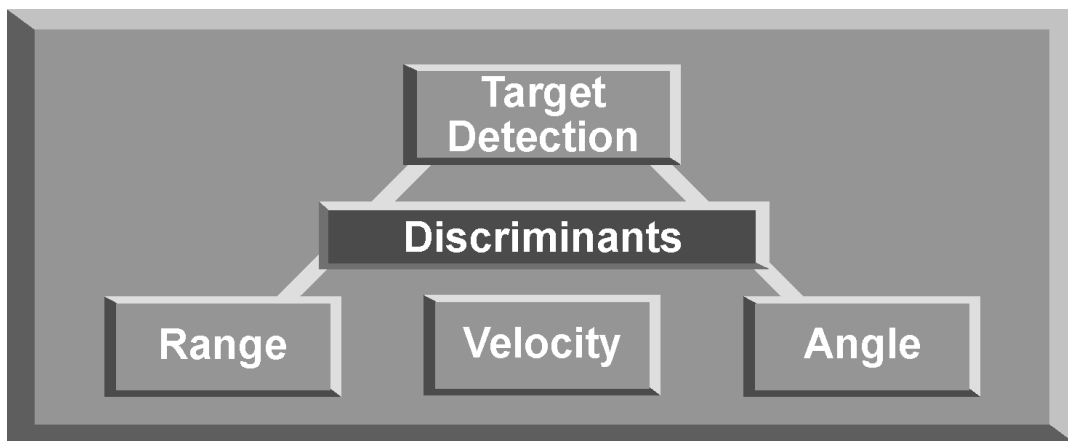

Figure 1-5. Radar Target Discriminants

a. The first target discriminant is range. The time an RF wave takes to go to, and return from, a target allows measurement of the range to that target. We know that RF energy travels at the speed of light, or “c” which is 3×10^8 meters per second. Target range can be determined by using the basic radar range equation (Equation 1-1), target range equals measured time, multiplied by the speed of light (“c”), divided by 2.

Radar Range Equation

Speed of Light (c) = 3×10^8 meters/sec

Range = (Measured Time x c) ÷ 2

Equation 1-1. Basic Radar Range Equation

b. Target angle discrimination is another critical capability of radar systems. In order for a radar system to detect a target, the antenna must be pointed at the target during the transmission and reception of RF energy. The ability of a radar system to accurately determine angle is a function of the horizontal beamwidth of the antenna. If the radar sweep is referenced to true North, the angle of a radar return can be measured relative to true North (Figure 1-6).

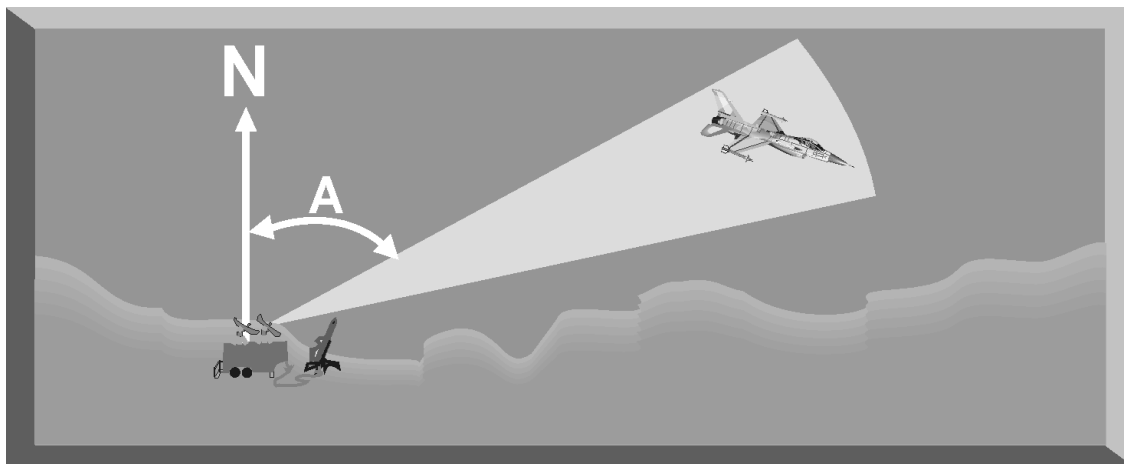

Figure 1-6. Angle Discrimination

c. Velocity discrimination is a specific capability of CW and pulse Doppler radar systems. The transmitters of CW radars send out continuous RF at a specific frequency (Figure 1-7). The reflected signal frequency is changed, or shifted, by a specific amount by a moving target. This frequency shift, called the Doppler effect, allows the measurement of the velocity of that target relative to the radar. The receiver measures this frequency difference which equates to a specific radial velocity. Pulse Doppler radars can measure the Doppler effect while still obtaining the range.

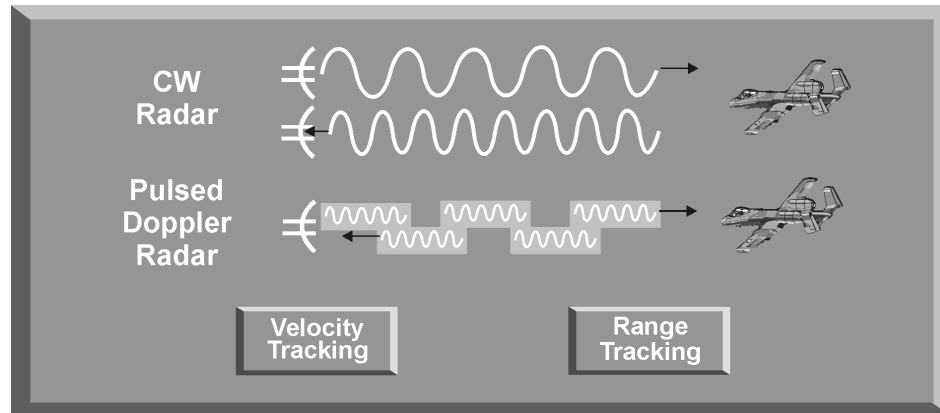

Figure 1-7. Velocity Discrimination

d. A basic pulse radar system consists of a transmitter, antenna, receiver, and a master timer (Figure 1-8). The transmitter sends electromagnetic energy (RF) to the antenna. This energy is radiated through the atmosphere. When this RF energy is interrupted by any object, such as a plane, ship, or the earth, a portion of the RF energy is reflected back to the antenna and processed by the receiver.

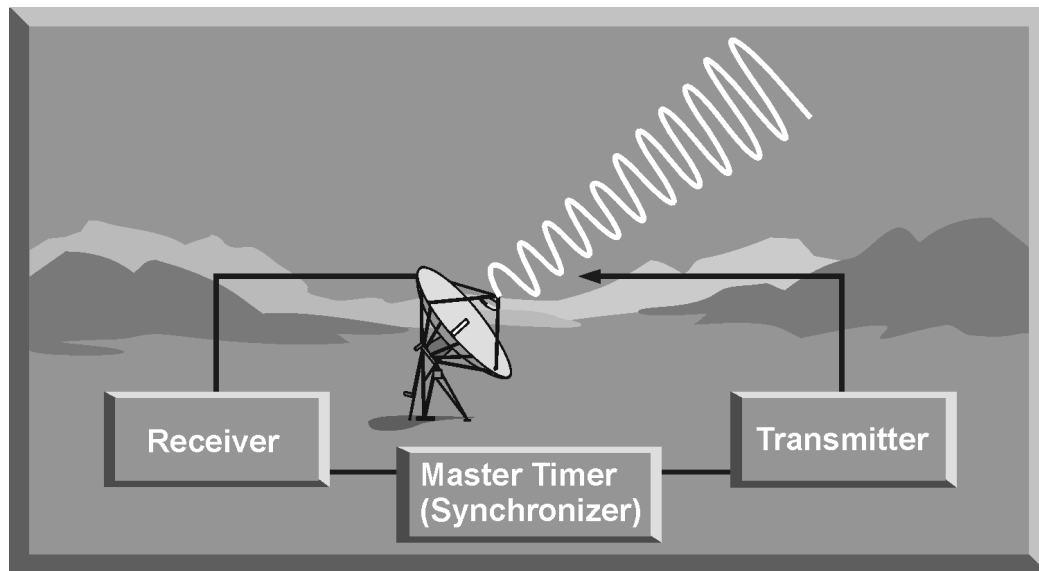

Figure 1-8. Basic Radar Operation

The reflection is called an echo, and the object interrupting the RF energy is called a target. The presence of an echo indicates target detection. If the target detected is the desired target, the echo is referred to as a target signal. If the echo is from undesired targets, such as the earth, the echo is referred to as clutter. This is especially true when the undesirable echoes make the detection of the desired target difficult. The capability of the antenna to focus the RF energy

affects the angular discrimination of the radar. The ability of the master timer to determine the time between RF transmission and target echo reception impacts the range determination capability of the radar. The ability of the receiver to analyze the Doppler frequency shift in the target echo determines the velocity discrimination capability of the radar and the ability of the radar to reject clutter.

4. INTRODUCTION TO INTEGRATED AIR DEFENSE SYSTEMS (IADS)

Radar systems have the inherent capability to determine accurate range, azimuth, and/or velocity information on airborne targets. Radar systems can provide this information in nearly all types of weather, day or night, and at distances that far exceed the capabilities of the human eye. Military commanders have taken advantage of these capabilities by employing radar systems to provide air defense for high-value targets. The primary missions of radar systems employed for air defense are attack warning and threat engagement.

a. Radar systems specifically designed to provide attack warning are called early warning (EW) radars (Figure 1-9). These radars are characterized by high power output, large antennas, and low frequencies. These same characteristics limit the accuracy of the target parameters available from early warning radars. The long-range detection of aircraft and the earliest possible attack warning capabilities of early warning radars provide the first line of defense for the air defense system.

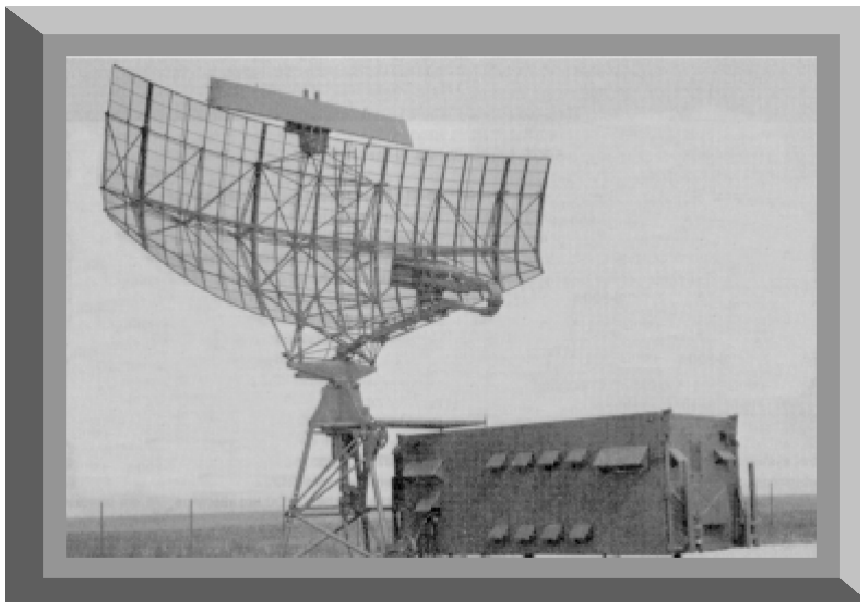

Figure 1-9. Early Warning Radar System

b. Radar systems designed to provide target engagement information include ground control intercept (GCI) radars, acquisition radars, target tracking radars (TTRs), and airborne interceptor (AI) radars.

(1) GCI radars are designed to provide sufficiently accurate target aircraft range, azimuth, and altitude information to vector AI assets to intercept and destroy attacking aircraft (Figure 1-10). To provide this data, early warning radars can be deployed along with specialized height finder radars. This combination of radar systems is commonly referred to as a GCI site. Newer GCI radar systems, employing phased array antennas and Doppler processing, can provide the required 3-dimensional target information. Any radar system, or combination of radar systems, that can determine 3-dimensional target data, and is equipped with the communication equipment to pass this information to AI assets, can act as a GCI site. GCI radar systems can be used to supplement early warning radar systems to provide critical attack warning.



Figure 1-10. GCI Radar

(2) Acquisition radar systems are designed to act as GCI radars for ground based TTRs. Acquisition radar systems generally have shorter range capability than early warning radars and operate at higher frequencies. These radar systems provide accurate target range and azimuth data to TTRs to facilitate target engagement. Acquisition radars can be a distinct radar system (Figure 1-11) or be incorporated as part of the TTR (Figure 1-12).

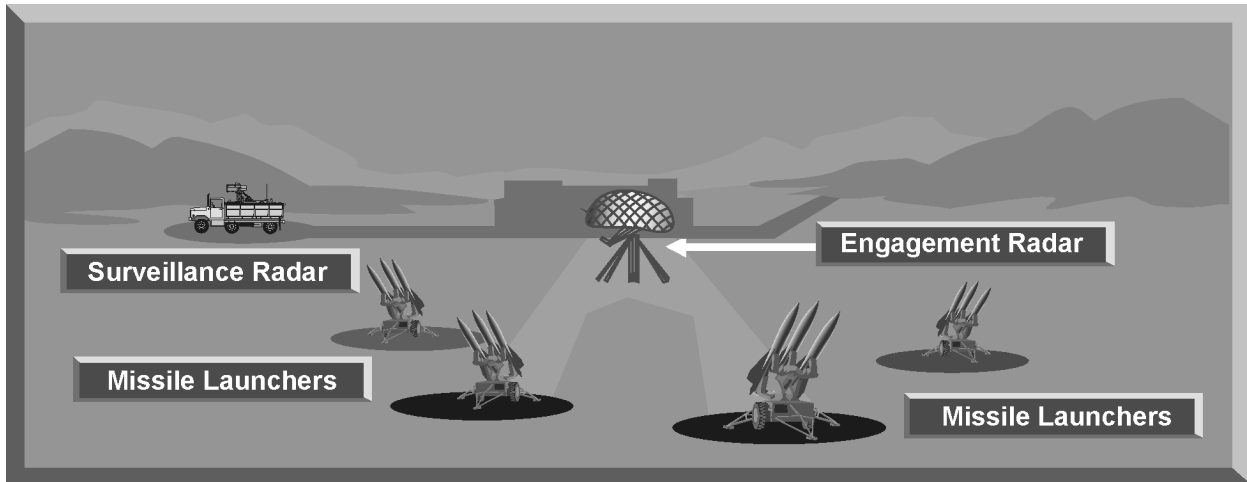

Figure 1-11. Acquisition Radar and TTR



Figure 1-12. TTR with Acquisition

(3) The primary role of TTRs, in support of an air defense system, is to provide continuous and accurate target parameters to a fire control computer. The fire control computer uses this data to guide missiles or aim antiaircraft artillery (AAA) to destroy attacking aircraft. TTRs employ various tracking techniques to continuously update target parameters. TTRs generally employ high frequencies, narrow beamwidths, and computer signal processing to enhance the accuracy of target parameters provided to the fire control computer.

(4) AI radar systems are TTRs employed by fighter aircraft to engage and destroy airborne targets (Figure 1-13). These radar systems are characterized by high frequency, sophisticated computer processing, and accurate target tracking capability. They are designed to allow the AI asset to employ air-to-air missiles and guns/cannons. TTRs and AI radars constitute the highest radar threat associated with an air defense system.

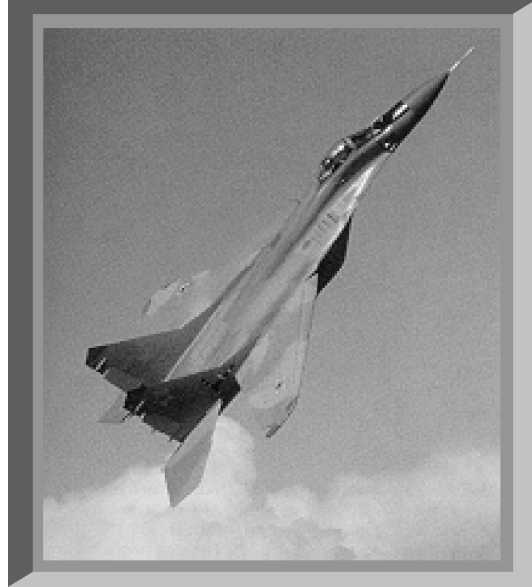

Figure 1-13. MiG-29

(5) Another growing lethal threat associated with an air defense system is infrared (IR) missiles. IR missile systems can be man-portable (Figure 1-14), mounted on vehicles, or employed by AI assets. These missile systems guide on the distinctive IR signature of aircraft. The recent proliferation and enhanced performance of IR systems has increased the contribution of these systems to air defense.



Figure 1-14. IR System

c. All these radar systems can be deployed to provide air defense for a particular country or geographical area. When the employment of these radar systems is integrated by a command and control (C²) structure, this constitutes an IADS (Figure 1-15). The C² structure allows the military commander to take advantage of the threat warning provided by early warning radars. Based on this threat warning, the military commander can allocate specific assets (GCI and AI assets, or acquisition radars and TTRs) to engage airborne targets. This allocation decision is based on the capabilities of these systems and the tactical situation. This allocation process enables the military commander to maximize the capabilities of his forces to engage and destroy attacking aircraft.

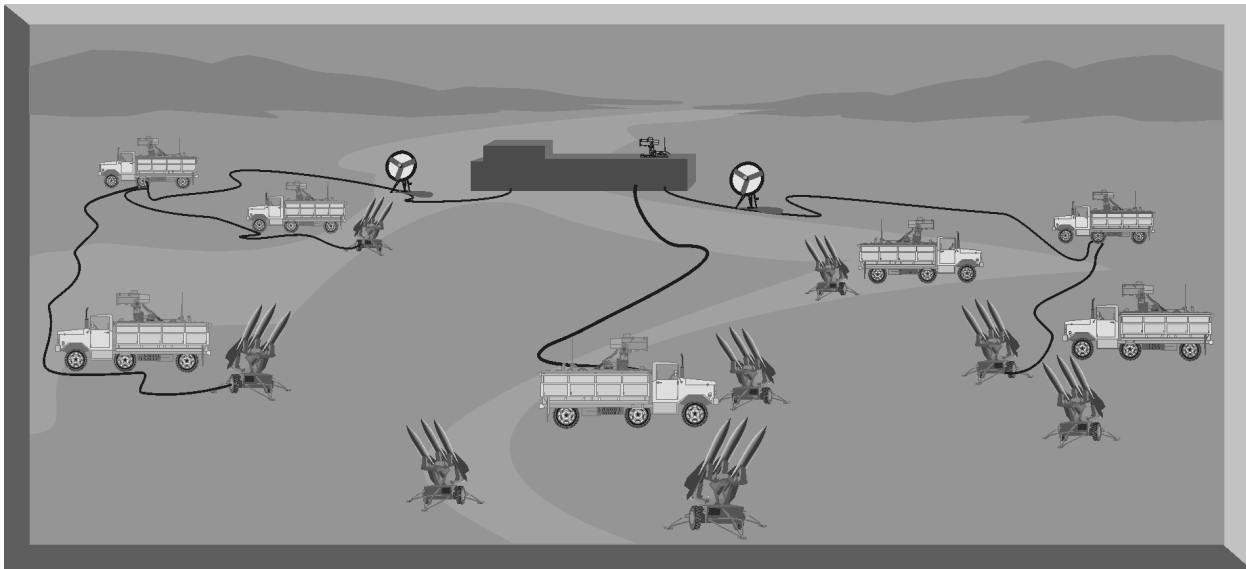

Figure 1-15. A Typical IADS

5. SUMMARY

Radar systems are the cornerstones of a modern IADS. Radar and IR threat systems operate at frequencies that span most of the electromagnetic spectrum. Each system has unique capabilities and operating characteristics that enable it to accomplish assigned tasks in support of the IADS. In order to effectively employ offensive air power on the modern battlefield, the systems that support the IADS must be negated. A basic knowledge of how radar and IR systems operate, their capabilities, limitations, and the available countermeasures is the key to defeating these systems. The purpose of this book is to provide this information.

CHAPTER 2. CHARACTERISTICS OF RF RADIATION

1. INTRODUCTION

In order for a radar system to determine range, azimuth, elevation, or velocity data, it must transmit and receive electromagnetic radiation. This electromagnetic radiation is referred to as radio frequency (RF) radiation. RF transmissions have specific characteristics that determine the capabilities and limitations of a radar system to provide these target discriminants, based on an analysis of the characteristics of the target return. The frequency of transmitted RF energy affects the ability of a radar system to analyze target return, based on time, to determine target range. RF frequency also affects the ability of the transmitting antenna to focus RF energy into a narrow beam to provide azimuth and elevation information. The wavelength and frequency of the transmitted RF energy impact the propagation of the radar signal through the atmosphere. The polarization of the RF signal affects the amount of clutter the radar must contend with. The ability of a radar system to use the Doppler effect in analyzing the radar return impacts the velocity discrimination capability of the radar. These characteristics of RF radiation will be discussed in this chapter.

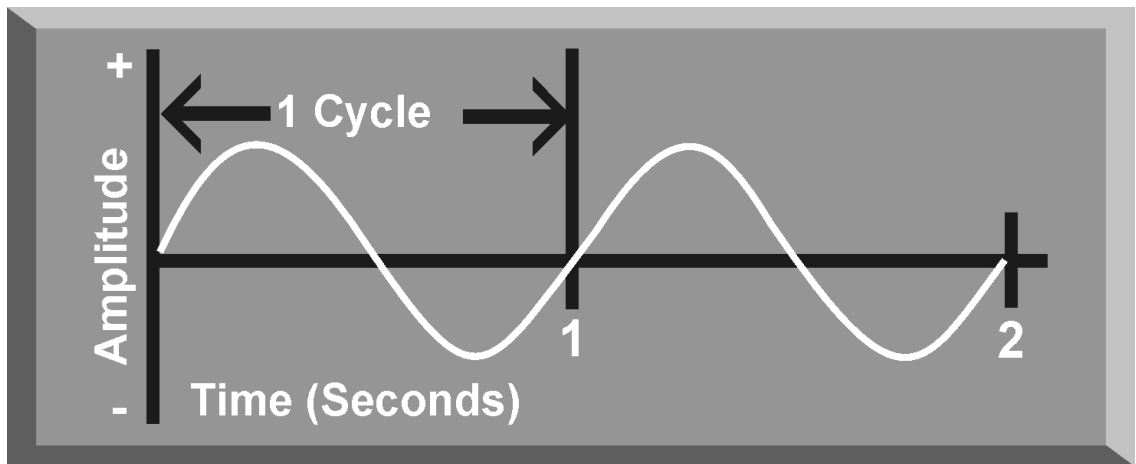

Figure 2-1. Radio Frequency

2. FREQUENCY

The output signal from a typical radio or radar system has several important characteristics that affect the capabilities and limitations of radio or radar systems. The first characteristic considered is usually RF. The frequency of the transmitted signal is the number of times per second the RF energy completes one cycle. The RF signal depicted in Figure 2-1 has a frequency of one cycle per second. The basic unit of measurement is the hertz (Hz). One hertz equals one cycle per second. Most radars have an RF in the millions of hertz, or megahertz (MHz).

3. WAVELENGTH

A characteristic of any RF signal is wavelength. Wavelength is a measure of the physical distance between peaks of a sine wave propagated in space (Figure 2-2).

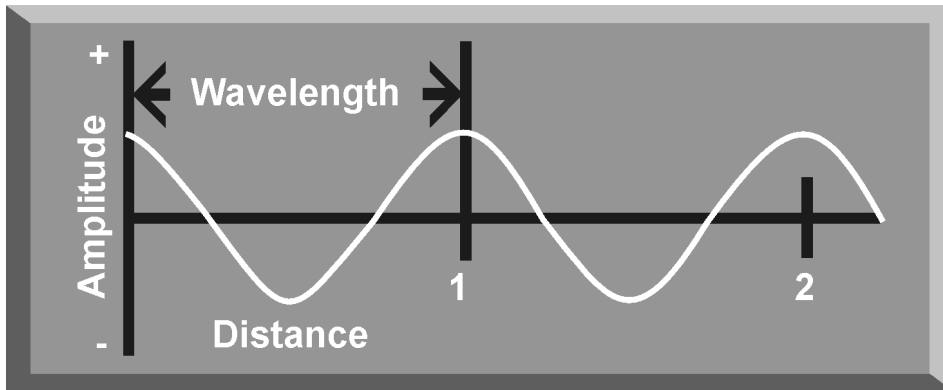

Figure 2-2. Radar Signal Wavelength

Though wavelength is measured in meters, most radar signals have wavelengths measured in centimeters or millimeters. The wavelength of a radar signal can be computed using the equation shown in Equation 2-1. The relationship between wavelength and frequency is inverse: the higher the frequency, the shorter the wavelength. In early radio and radar terminology, wavelength was used instead of frequency to describe operating characteristics of a system. Today, wavelength is used to describe systems operating at very high frequencies, such as millimeter wave, and for describing infrared (IR) systems.

$$\text{Wavelength } (\lambda) = \frac{c}{f} \quad \begin{array}{l} \text{(Speed of Light)} \\ \text{(Radar Frequency)} \end{array}$$

Equation 2-1. Basic Wavelength Equation

4. POLARIZATION

Another characteristic of a radio frequency wave is polarization. Polarization is determined by the radar antenna and refers to the orientation of the RF wave as it travels through space. There are two types of polarization: linear and circular.

a. Traveling electromagnetic energy has two components: an electrostatic field and a magnetic field. These two fields are always perpendicular to each other and perpendicular to the direction of travel. The polarization of the wave is defined in terms of the orientation to the electrostatic field. Many radar antennas are linearly polarized, either vertically or horizontally. The signal depicted in Figure 2-3 is vertically polarized.

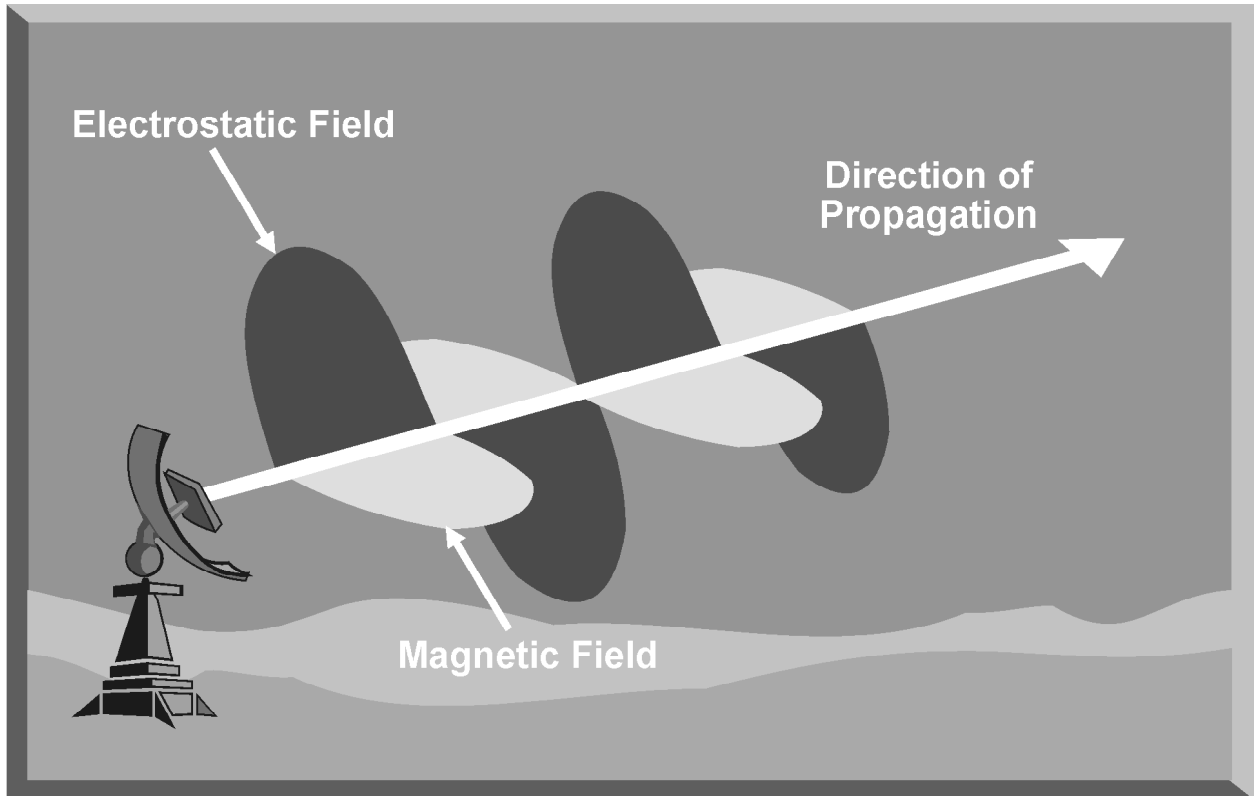

Figure 2-3. Radar Signal Vertical Polarization

b. Some radars use circular polarization to improve target detection in rain. Circular polarization can be right-hand, or left-hand orientation. For circular polarization, the direction of the electrostatic field varies with time and traces a circular locus about a fixed plane perpendicular to the direction of propagation. For a right-hand circular polarized signal, the electrostatic vector appears to rotate in a clockwise direction. For a left-hand circular polarized signal, the rotation is counterclockwise. Circular polarization can be visualized by pointing the thumb of either hand in the direction of propagation and curling the fingers in the direction of electrostatic field rotation (Figure 2-4).

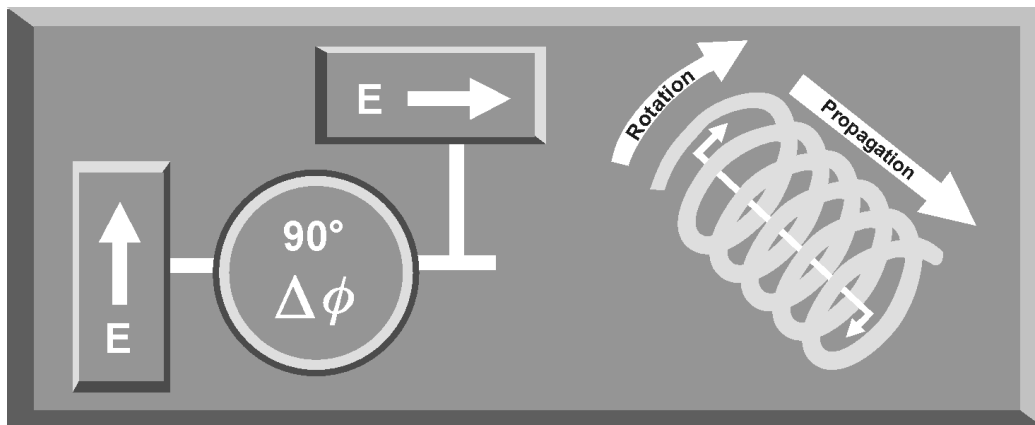

Figure 2-4. Circular Polarization

c. The impact of polarization on receivers and transmitters is fairly straightforward. If an antenna is designed to receive a particular polarization, it will have difficulty receiving a signal with an opposite polarization. This situation is defined as cross polarization (Figure 2-5).

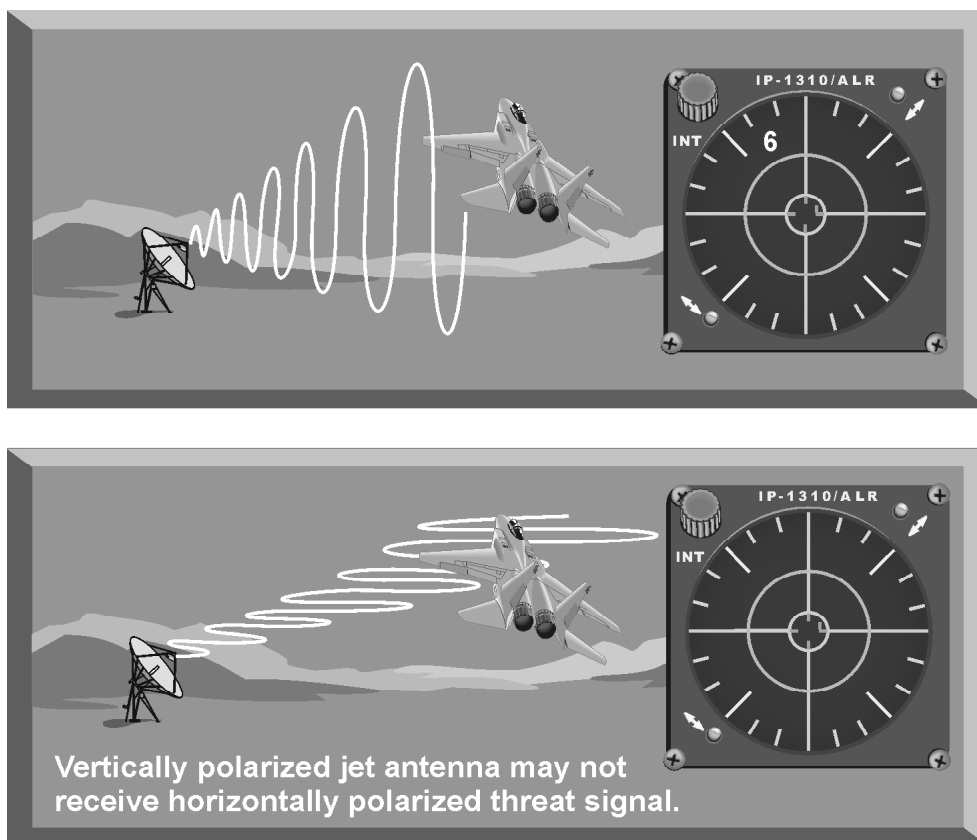

Figure 2-5. Impact of Polarization

The impact of cross polarization on electronic combat can be dramatic. If a radar warning receiver antenna is polarized to receive vertically polarized signals, a threat system employing a horizontally polarized radar signal may not be detected, or may be displayed on the scope well after the threat has acquired the aircraft. In addition, if the jamming antenna on an electronic attack (EA) system is also vertically polarized, it may not be able to jam this system. Fortunately, this potentially lethal situation rarely occurs, but future threat systems may take advantage of this situation. Table 2-1 details the impact of polarization on selected transmit and receive antenna combinations.

Table 2-1. Antenna Polarization Loss

Transmit Antenna Polarization	Receive Antenna Polarization	Percent Lost
Vertical	Vertical	0
Vertical	Slant (45° or 135°)	50
Vertical or Horizontal	Horizontal or Vertical	75
Vertical	Circular (right-hand or left-hand)	50
Horizontal	Horizontal	0
Horizontal	Slant (45° or 135°)	50
Horizontal	Circular (right-hand or left-hand)	50
Circular (right-hand)	Circular (right-hand)	0
Circular (right-hand)	Circular (left-hand)	94
Circular (right-hand or left-hand)	Slant (45° or 135°)	50

5. DOPPLER EFFECT

The “Doppler effect” takes advantage of the fact that the frequency of RF waves will be changed or shifted when reflected from a target moving relative to the radar. The shifted frequency of the returning RF wave depends on the movement of the aircraft in relation to the radar. In Figures 2-6, 2-7, and 2-8, f_o is the transmitted frequency of the radar, and f_r is the frequency of the reflected RF

wave from the target. For a stationary target, the frequency of the reflected signal will equal the frequency of the transmitted signal (Figure 2-6).

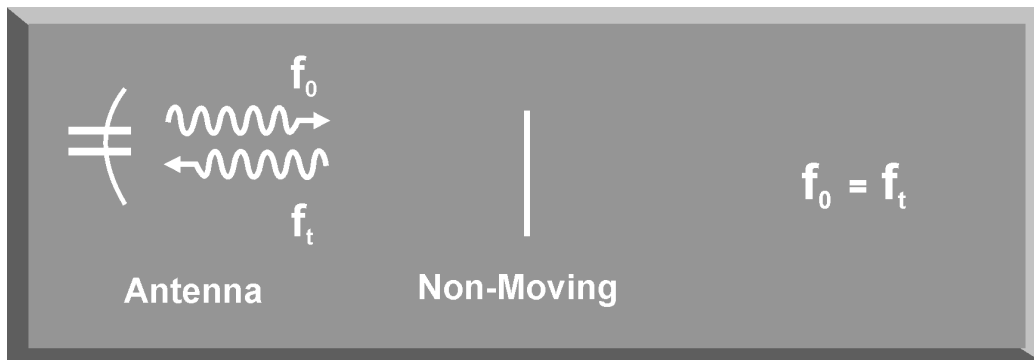

Figure 2-6. Zero Doppler Effect – Stationary Target

a. For a target moving toward the radar, the frequency of the reflected signal will be higher than the transmitted signal (Figure 2-7).

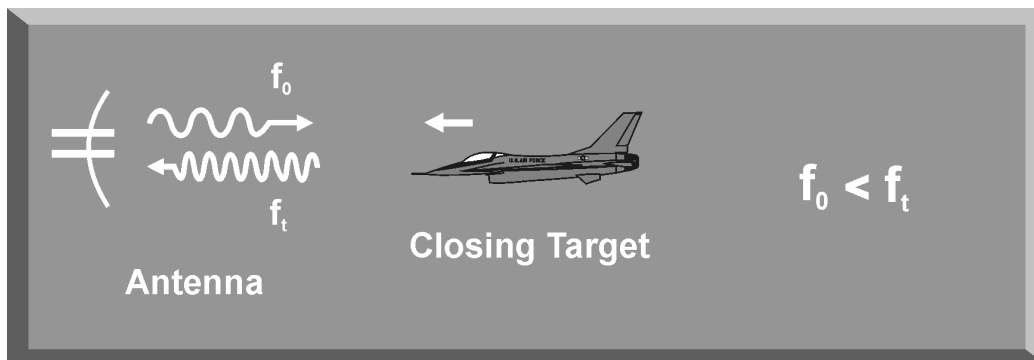

Figure 2-7. Doppler Effect – Closing Target

b. The reflected frequency for a target moving away from the radar will be lower than the transmitted frequency (Figure 2-8).

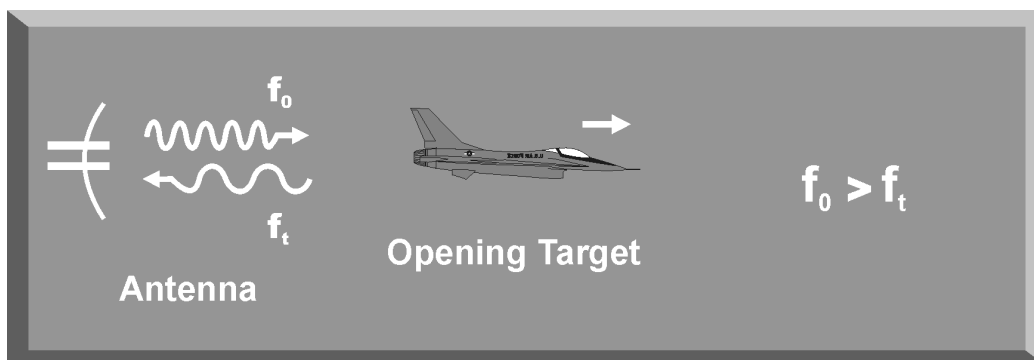

Figure 2-8. Doppler Effect – Opening Target

6. ELECTROMAGNETIC SPECTRUM

The portion of the electromagnetic spectrum (Figure 2-9) that today's electronic combat systems must deal with starts with radio waves and encompasses microwaves, infrared, and a small portion of the ultraviolet region. Communications systems generally operate in the HF, UHF, and VHF regions. Some satellite communications operate in the SHF region. Radars operate in the microwave region, normally from 0.2 – 200 gigahertz. Infrared systems operate in the region just below visible light.

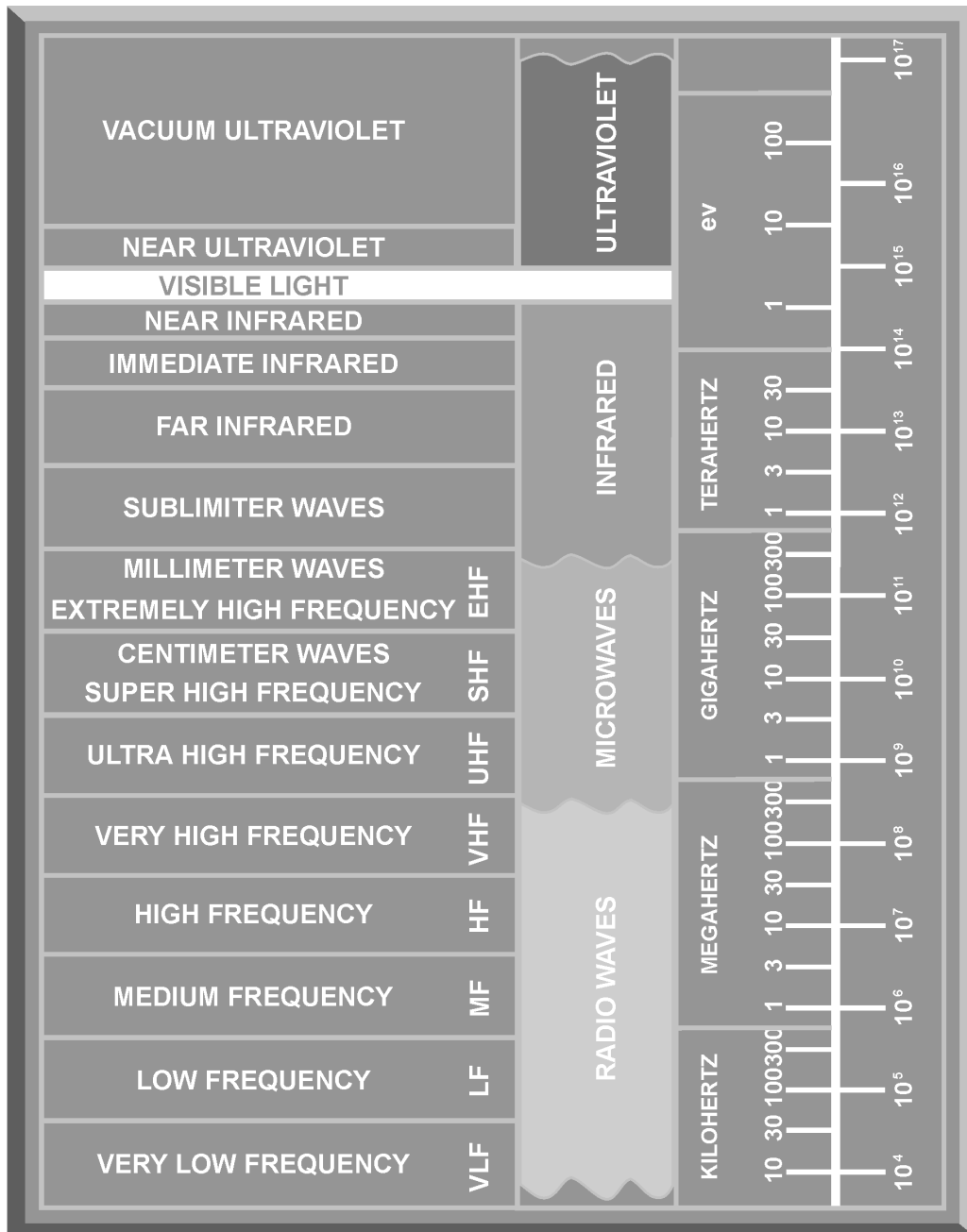

Figure 2-9. Electromagnetic Spectrum

a. Table 2-2 lists prefixes commonly used to indicate scientific notation and their abbreviations. These prefixes are often used when dealing with extremely high frequency radar signals or RF waves with extremely small wavelengths. For example, when dealing with extremely high frequency RF, it is simpler to use gigahertz, or GHz. One gigahertz is one thousand megahertz (MHz). For example, a radar operating at 3150 MHz is also operating at an RF of 3.150 GHz.

Table 2-2. Commonly Used Prefixes for Scientific Notation

Unit Designations			
Prefix	Symbol	Unit	Measure
Tetra	T	10^{12}	One Trillion
Giga	G	10^9	One Billion
Mega	M	10^6	One Million
Kilo	k	10^3	One Thousand
Cent	c	10^{-2}	One Hundred
Milli	m	10^{-3}	One Thousandth
Micro	u	10^{-6}	One Millionth

b. Frequency bands are often used when discussing radars and electronic combat systems. Radar designers use a frequency band designation system entirely different from the one used in electronic combat. Table 2-3 depicts both frequency band designation systems and the corresponding frequency ranges.

Table 2-3. Radar Frequency Band Designations

Frequency Range	EW Frequency Band	Radar Design Frequency Band
0-250 MHz	A	HF/VHF
250-500 MHz	B	UHF
500-1000 MHz	C	UHF
1-2 GHz	D	L
2-3 GHz	E	S
3-4 GHz	F	S
4-6 GHz	G	C
6-8 GHz	H	C
8-10 GHz	I	X (8-12.5 GHz)
10-20 GHz	J	Ku (12.5-18 GHz)
20-40 GHz	K	K (18-26.5 GHz)
40-60 GHz	L	Ka (26.5-40 GHz)
60-100 GHz	M	40-100 Millimeter

7. RF PROPAGATION

Propagation characteristics of RF energy are profoundly affected by the earth's surface and atmospheric conditions. Any analysis of radar performance must take into account the propagation phenomena associated with RF radiation in a “real world” environment. The most important propagation phenomena include refraction, anomalous propagation (ducting), and attenuation.

a. In a vacuum, RF waves travel in a straight line. However, RF waves propagating within the earth's atmosphere do not travel in a straight line. The earth's atmosphere bends, or refracts, RF waves. One impact of the atmospheric refraction of RF waves is an increase in the line of sight (LOS) of the radar. This increase in radar LOS effectively extends the range of the radar system (Figure 2-10).

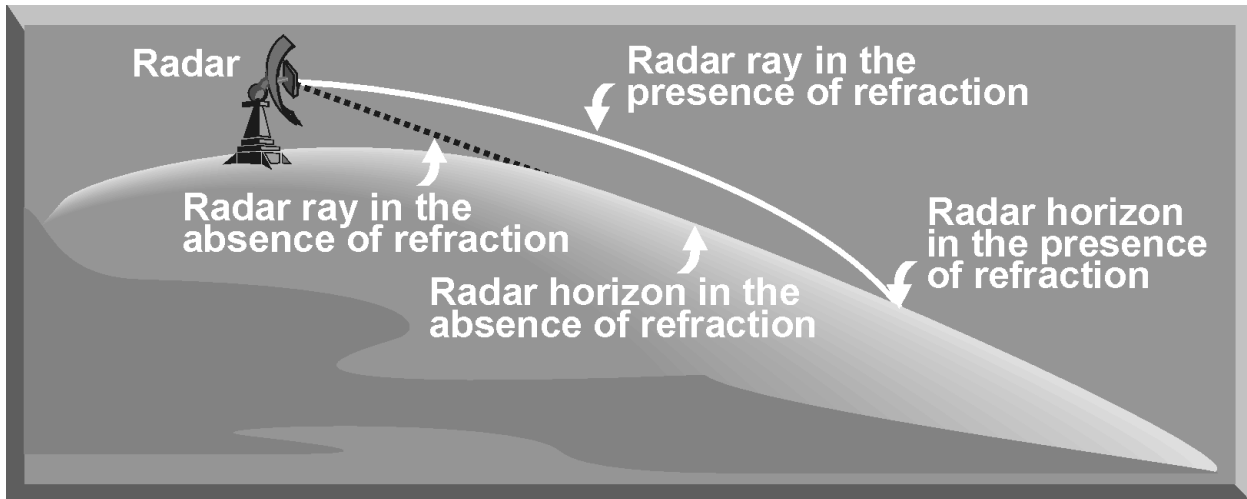

Figure 2-10. Impact of Refraction on RF Propagation

Atmospheric refraction of RF energy can also induce elevation measurement errors in radar systems (Figure 2-11).

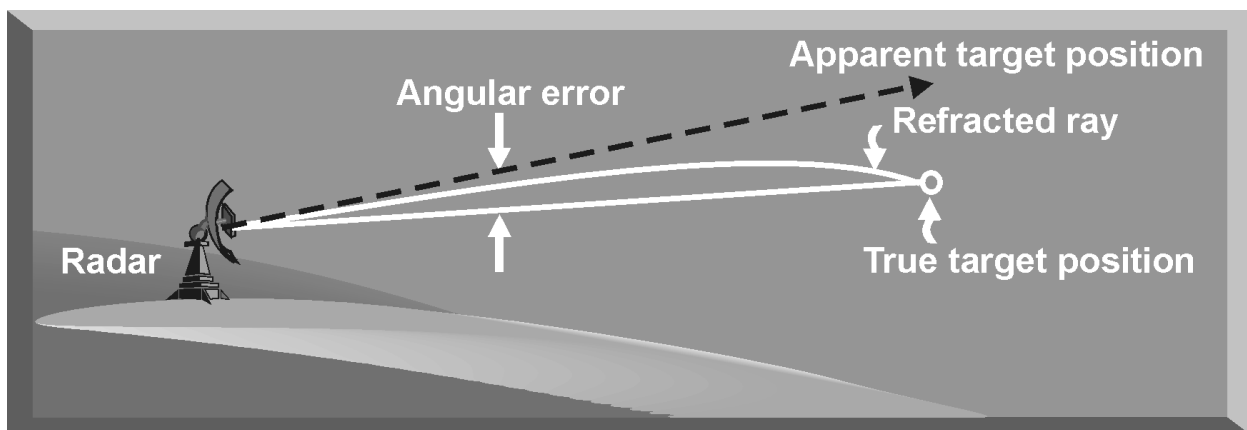

Figure 2-11. Impact of Refraction on Target Elevation Determination

(1) The refraction of RF waves in the atmosphere is caused by the variation in the velocity of propagation with altitude. The index of refraction (n) is used to describe this velocity variation and is defined by Equation 2-2.

$$\text{Index of Refraction (n)} = \frac{\text{Velocity of Propagation in a Vacuum}}{\text{Velocity of Propagation in the Atmosphere}}$$

Equation 2-2. Index of Refraction

(2) The term refractivity (N) is used for predicting the impact of refraction on RF wave propagation. Refractivity is a “scaled up” expression for the index of refraction and is used by radar designers to calculate the impact of refraction on actual radar systems. At normal radar operating frequencies, the refractivity for air containing water vapor can be computed using Equation 2-3.

$$\text{Refractivity (N)} = (n-1) \times 10^6 = \frac{77.6 p}{T} + \frac{3.75 \times 10^5 e}{T^2}$$

n = index of refraction e = partial pressure of water vapor
p = barometric pressure T = absolute temperature (degrees K)

Equation 2-3. Refractivity of RF Waves (Normal Radar Frequencies)

(3) As altitude increases, the barometric pressure and water vapor content decrease rapidly. At the same time, the absolute temperature decreases slowly based on the standard lapse rate. Using Equation 2-3, it can be seen that the refractivity of the atmosphere decreases with increasing altitude. This decrease in refractivity means that the velocity of RF waves increases with altitude. The result is a downward bending, or refraction, of RF waves as depicted in Figure 2-10. RF wave refraction primarily affects ground-based radar systems at low antenna elevation angles, especially at or near the horizon. For most radar applications, refraction is not a factor at elevation angles above 5 degrees.

b. The term anomalous, or nonstandard, propagation is used to describe atmospheric conditions that extend the propagation of RF waves and increase radar range. The most common anomalous propagation phenomena is called superrefraction, or ducting.

(1) A superrefracting duct is formed when the refractivity of the atmosphere (Equation 2-2) rapidly decreases with altitude. Based on Equation 2-2, this occurs when the temperature increases with altitude and/or the water vapor content decreases with altitude. An increase in temperature with altitude is called a temperature inversion. To produce a duct, the temperature inversion must be very pronounced.

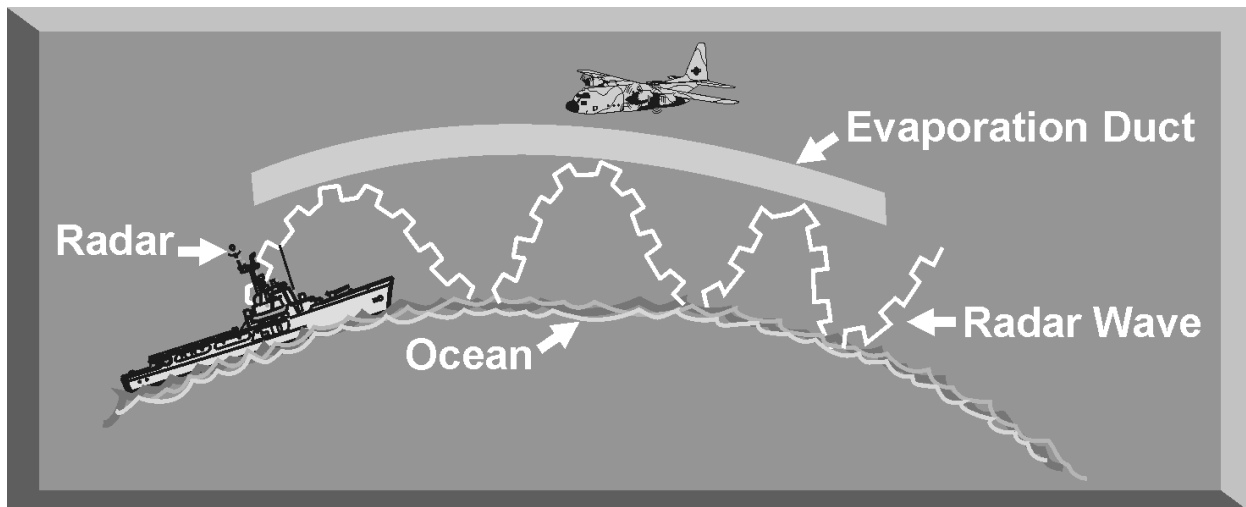

Figure 2-12. Superrefracting Surface Duct

(2) A superrefracting duct acts like a wave guide which traps the RF wave (Figure 2-12). This channels the radar signal and reduces attenuation. In order for an RF wave to propagate within a duct, the angle of the radar signal, in relation to the duct, should be less than one degree. The RF waves trapped by the duct take advantage of the decrease in refractivity and travel much further than normal. This can greatly extend the range of a radar system.

(3) The extension of radar range inside a duct can result in a reduction of radar coverage outside the duct. The area of reduced radar coverage because of ducting is called a radar hole. Due to radar holes, the extended radar range caused by ducting may result in a decrease in radar coverage along other paths of propagation. These holes can seriously degrade the effectiveness of early warning radar systems. For example, a radar system is taking advantage of a duct formed at the surface to extend low altitude radar range (Figure 2-12). Airborne targets flying just above the duct would normally be detected, but because of ducting, these targets may be missed.

(4) Water vapor content is a significant factor in producing ducts. Consequently, most ducts are formed over water and in warm climates. Any atmospheric phenomenon that results in a pronounced increase in temperature and/or a decrease in water vapor content as altitude increases can generate a superrefracting duct, of which there are three types. A superrefracting duct which is formed just above the surface of the earth is referred to as a surface duct. A surface duct formed just above the surface of the ocean is called an evaporation duct. A duct which is formed well above the surface of the earth is known as an elevated duct.

(a) Surface ducts formed over land are usually a result of the nighttime radiation of heat from the earth. Duct formation is especially prevalent during the

summer months when the ground is moist. As the earth loses heat, a temperature inversion is created at the surface coupled with a sharp decrease in the moisture content. These conditions are favorable to the formation of a surface duct. A superrefracting duct can also be produced by the diverging downdraft under a thunderstorm. The cool air that is dispersed creates a local temperature inversion while the water vapor content decreases due to rain. Surface ducts formed in conjunction with thunderstorms are difficult to predict and normally persist for a short period of time.

(b) A superrefracting surface duct that lies just above the surface of the ocean is a result of evaporated water, thus the term evaporation duct. The air in contact with the ocean is saturated with water vapor, while the air several feet above the ocean contains a much lower level. This rapid decrease in water vapor pressure with an increase in altitude creates an evaporation duct. An evaporation duct exists over the ocean almost all the time. The height of this duct varies from 20 to 100 feet based on the season, time of day, and wind speed. One positive aspect of an evaporation duct is the extended range available to a shipborne radar system with a properly aligned antenna. This extended range coverage against surface ships and low altitude aircraft is a definite advantage of ducted propagation.

(c) An elevated duct is generally formed by a temperature inversion in the upper atmosphere. To take maximum advantage of the increased radar range inside an elevated duct, both the radar and the target should be inside the elevated duct. In addition, radar systems operating below an elevated duct may also experience enhanced range performance.

(4) The presence of surface ducts and elevated ducts, especially over land, are extremely difficult to predict and may persist for very short periods of time. The atmospheric conditions favorable to duct formation are difficult to predict using conventional weather forecasting techniques.

c. The attenuation of RF energy in a clear atmosphere is due to the presence of oxygen and water vapor. Attenuation results when a portion of the RF energy strikes these molecules and is absorbed as heat. Figure 2-13 details the RF attenuation loss due to atmospheric gasses based on the frequency of the RF energy.

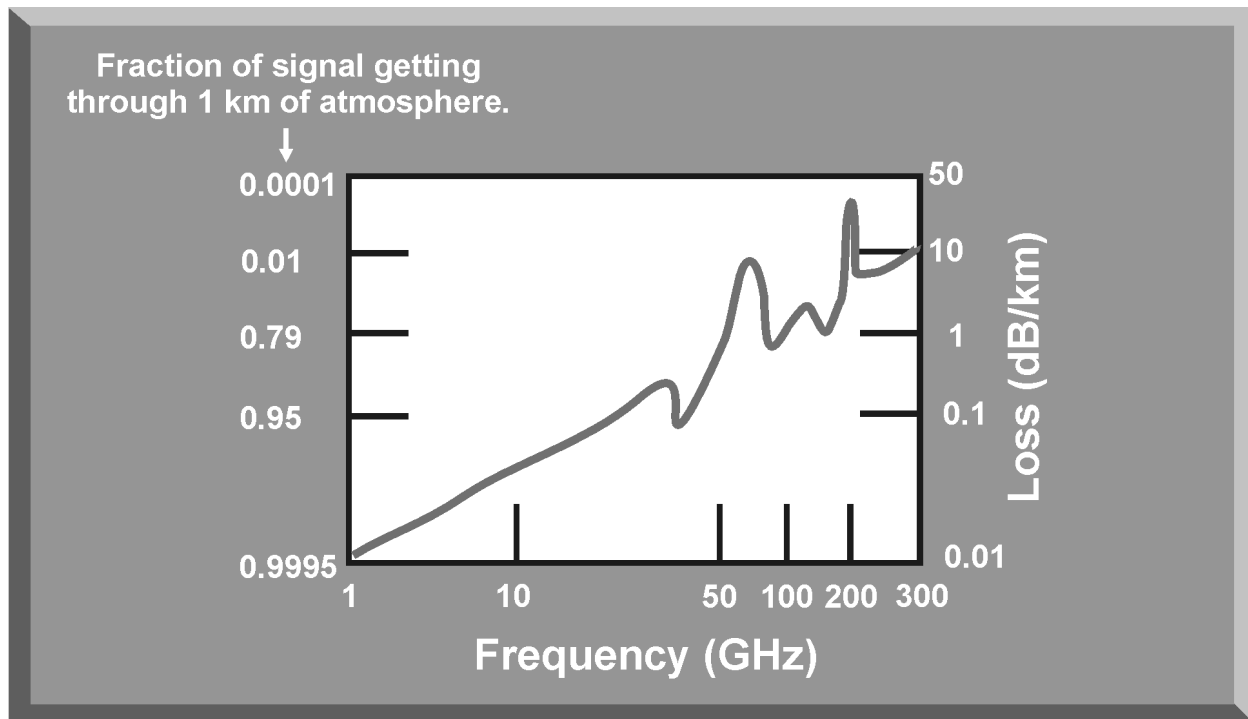

Figure 2-13. RF Atmospheric Attenuation

(1) At frequencies below 1 GHz, the effect of atmospheric attenuation is negligible. Above 10 GHz, atmospheric attenuation increases dramatically. This dramatic signal loss impacts the maximum detection range of radars operating in the millimeter wavelength band.

(2) RF energy attenuation decreases as altitude increases. The RF attenuation experienced by an air-to-air radar will depend on the altitude of the target as well as target range. For a ground-based radar, RF attenuation will decrease as antenna elevation increases.

8. SUMMARY

Since all radar operations depend on the transmission and reception of RF energy, a basic knowledge of RF frequency, wavelength, and polarization provides the basis for understanding the more complex radar characteristics. Since most modern radar systems employ some form of Doppler signal processing, the concept of the Doppler effect is fundamental to understanding modern radar operation. The concepts of refraction, anomalous propagation (ducting), and atmospheric attenuation are key to understanding how RF waves propagate in the atmosphere. The topics in this chapter provide a foundation for understanding radar and jamming system operation.

CHAPTER 3. RADAR SIGNAL CHARACTERISTICS

1. INTRODUCTION

Every radar produces a radio frequency (RF) signal with specific characteristics that differentiate it from all other signals and define its capabilities and limitations. Pulse width (pulse duration), pulse recurrence time (pulse repetition interval), pulse repetition frequency, and power are all radar signal characteristics determined by the radar transmitter. Listening time, rest time, and recovery time are radar receiver characteristics. An understanding of the terms used to describe these characteristics is critical to understanding radar operation.

2. PULSE WIDTH (PW)

Figure 3-1 depicts the output from a typical pulse radar. PW, sometimes called pulse duration (PD), is the time that the transmitter is sending out RF energy. PW is measured in microseconds. It has an impact on range resolution capability, that is, how accurately the radar can discriminate between two targets based on range.

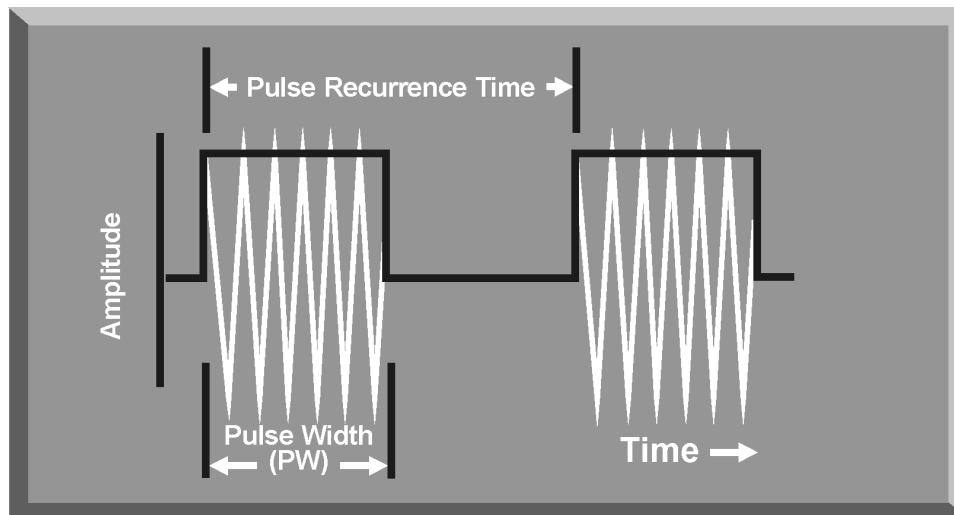

Figure 3-1. Typical Radar Pulse

3. PULSE RECURRENCE TIME (PRT)

Pulse recurrence time is also known as pulse repetition time. PRT is the time required for a complete transmission cycle. This is the time from the beginning of one pulse of RF energy to the beginning of the next. PRT is measured in microseconds. PRT is the same as pulse repetition interval (PRI), which is used in radar warning receivers and other electronic warfare support (ES) assets to discriminate between radar systems. It also affects maximum radar range.

4. PULSE REPETITION FREQUENCY (PRF)

One of the most important characteristics of a pulse radar signal is pulse repetition frequency. PRF is the rate at which pulses or pulse groups are transmitted. Generally, PRF is the number of pulses generated per second and is expressed in hertz (Hz). PRF and PRI are related in that PRI is the inverse of PRF. A word of caution—do not confuse the operating frequency of the radar, which is measured in Hz, with the pulse repetition frequency, which is also measured in Hz. They are entirely different characteristics of a pulsed radar signal.

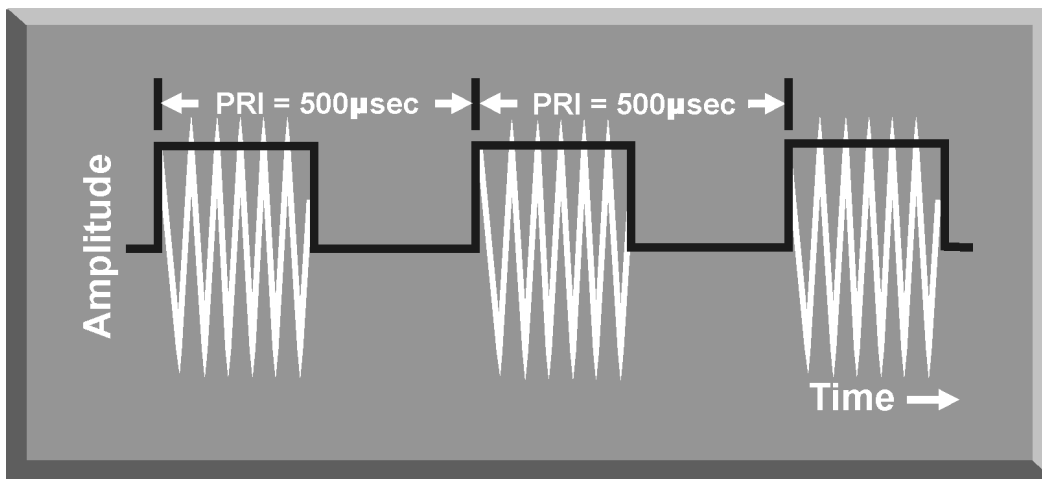

Figure 3-2. Constant PRF Radar Pulse

a. A pulse radar operating at an unvarying PRF is called a constant PRF radar (Figure 3-2). Pulse radar systems can employ PRF stagger or PRF jitter as an electronic protection (EP) technique against repeater or synchronous jammers. The time between each pulse is the PRI.

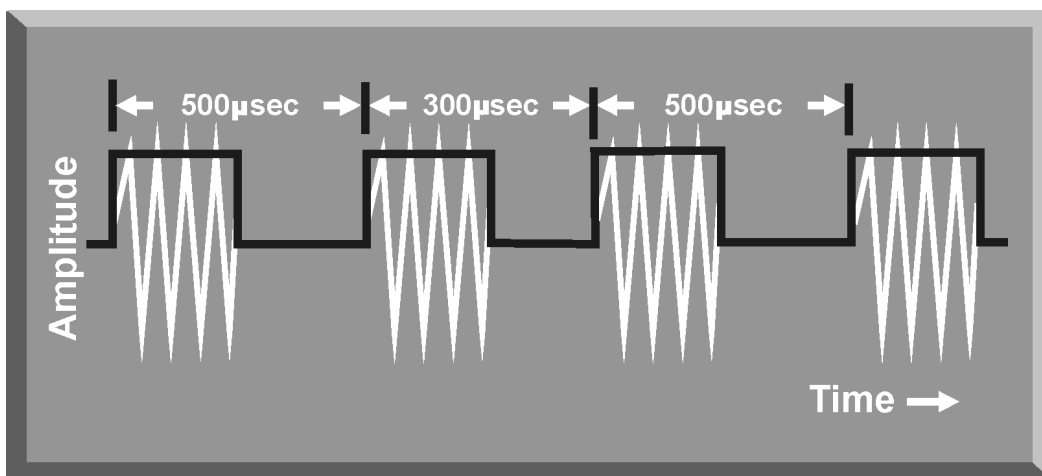

Figure 3-3. PRF Stagger

b. PRF stagger is accomplished by assuring that no adjacent PRIs are equal. The number of different PRIs generated is called the “position” of the stagger. Two-position stagger would have two PRI values, for example, 300 microseconds and 500 microseconds (Figure 3-3).

c. PRF jitter may be considered a random stagger. It is also an EP technique to counter synchronous jammers. PRF jitter has no repeating pattern of PRI values (Figure 3-4).

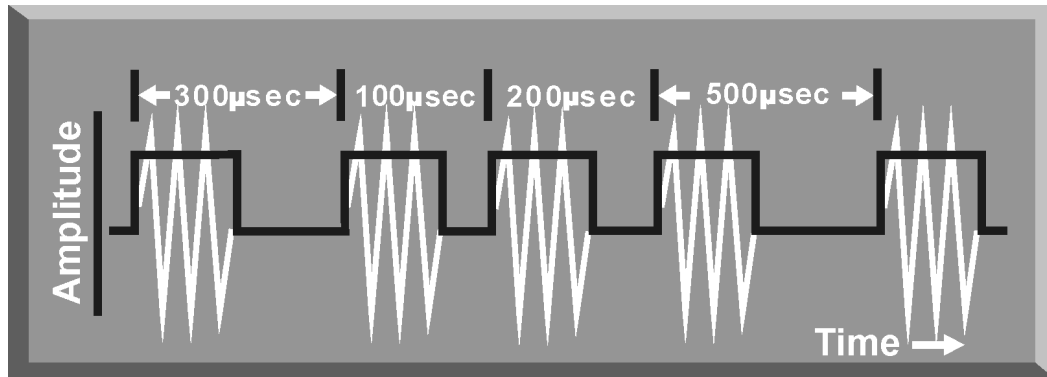

Figure 3-4. PRF Jitter

5. RADAR RECEIVER CHARACTERISTICS

Pulse repetition frequency, pulse recurrence time, and pulse width are determined by the transmitter. The pulse radar signal characteristics that relate to receiver operation are rest time, recovery time (RT), and listening time (LT) (Figure 3-5).

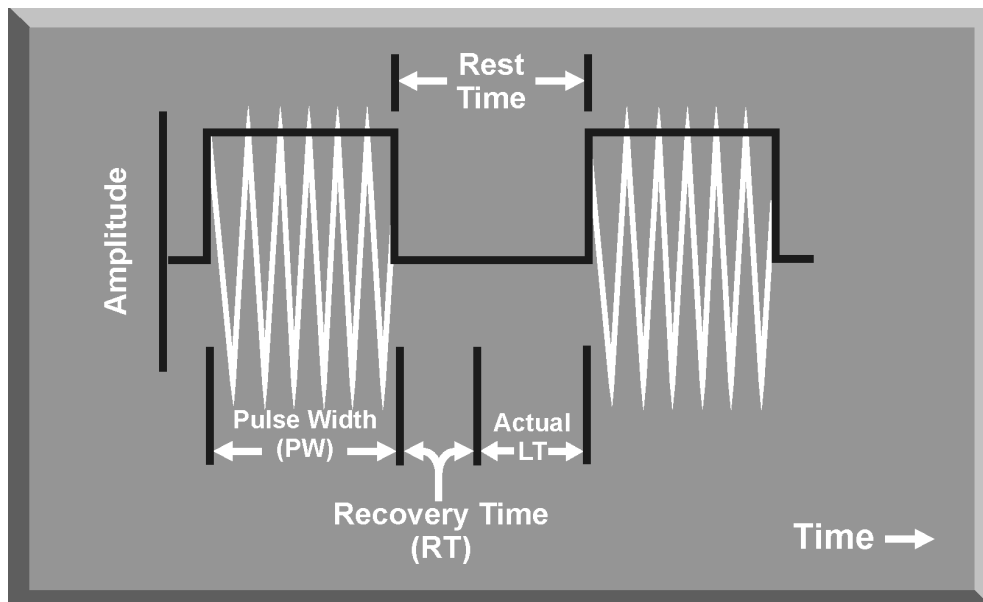

Figure 3-5. Basic Radar Pulse

a. Rest time is the time between the end of one transmitted pulse and the beginning of the next. It represents the total time that the radar is not transmitting. Rest time is measured in microseconds.

b. Recovery time (RT) is the time immediately following transmission time during which the receiver is unable to process returning radar energy. RT is determined by the amount of isolation between the transmitter and receiver and the efficiency of the duplexer. A part of the high power transmitter output spills over into the receiver and saturates this system. The time required for the receiver to recover from this condition is RT.

c. Listening time (LT) is the time the receiver can process target returns. Listening time is measured from the end of the recovery time to the beginning of the next pulse, or PRT minus (PW + RT). Listening time is measured in microseconds.

6. DUTY CYCLE

Duty cycle is the ratio of the time the transmitter operates to the time it could operate during a given transmission cycle. The duty cycle of a radar can be computed by dividing the PW by the PRT, or by multiplying the PW times the PRF. Duty cycle has no units (Equation 3-1). CW radars have a duty cycle of 100%, while early warning radars may have a duty cycle of around 1%.

$$\text{Duty Cycle} = \frac{\text{PW}}{\text{PRT}} \text{ or } \text{Duty Cycle} = \text{PW} \times \text{PRF}$$

Equation 3-1. Duty Cycle

7. PEAK POWER

The power output of a radar is normally expressed in terms of peak power or average power (Figure 3-6). Peak power is the amplitude, or power, of an individual radar pulse. It is simply the power, measured in watts or megawatts, that is radiated when the transmitter is on. The power a radar transmits is normally used to determine the maximum detection range of that radar. However, it is the energy in a radar pulse that determines maximum radar detection range. Since power is the rate of flow of energy, the energy in a radar pulse is equal to the peak power multiplied by the time the radar is transmitting, or pulse width (Equation 3-2).

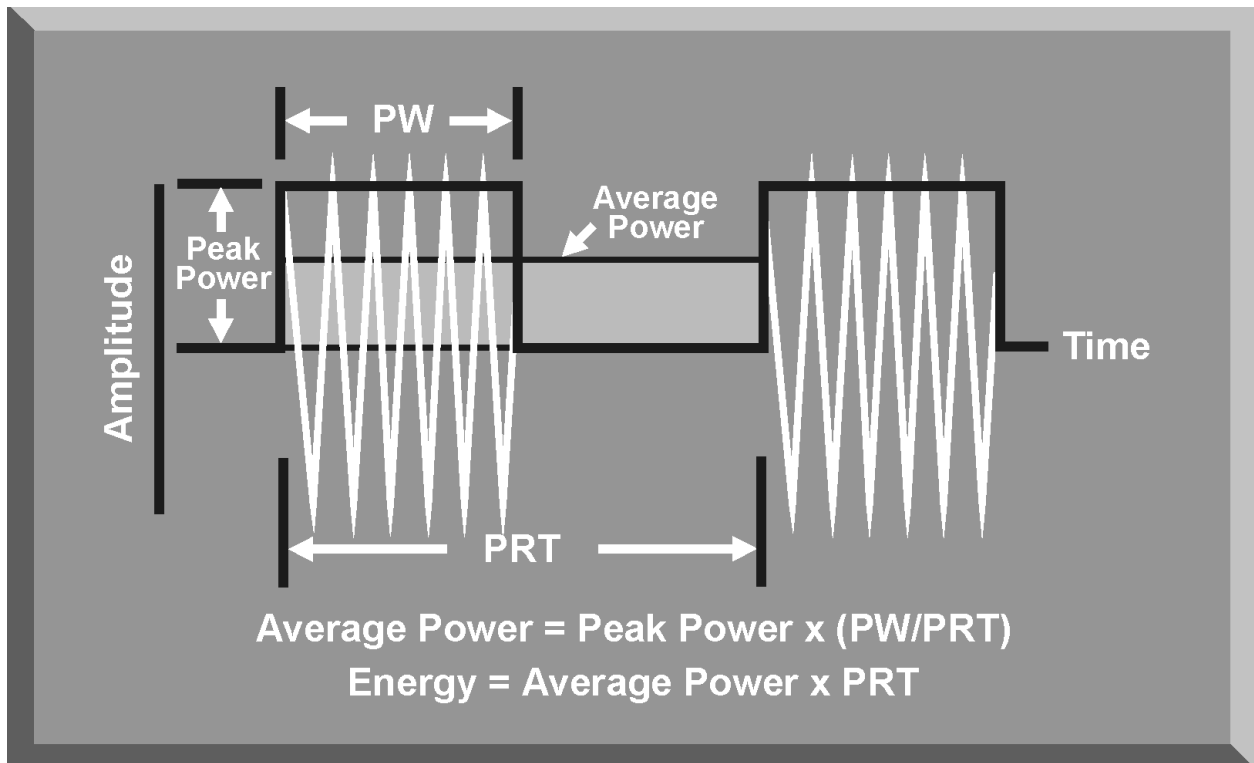

Figure 3-6. Peak Power and Average Power

$$\text{Energy Per Pulse} = \text{Peak Power} \times \text{Pulse Width}$$

Equation 3-2. Energy Per Pulse

8. AVERAGE POWER

Average power is the power distributed over the pulse recurrence time. It can be computed using the formula in Figure 3-6. The energy transmitted by average power can be computed by multiplying average power by PRT. Since the energy in a set of pulses determines detection range, average power or energy provides a better measure of the detection range of a radar than does peak power. Average power can be increased by increasing the PRF, by increasing the pulse width, or by increasing peak power (Figure 3-7).

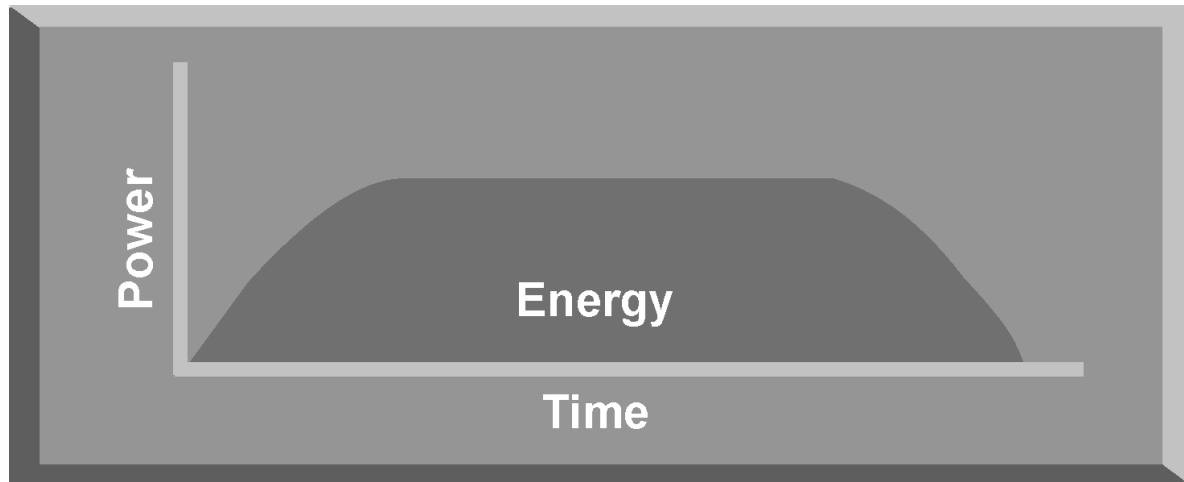

Figure 3-7. Radar Power and Energy

9. MODULATION

The characteristics of an RF signal must be changed in order to transmit information on the signal. This process is called modulation. Modulation is accomplished by combining a basic RF signal, called a carrier wave, with a modulating signal that contains the desired information. The resulting waveform is then used to transmit the desired information.

a. One basic modulation technique is amplitude modulation (AM). The carrier wave is combined with a modulating signal containing information of varying amplitude. Waveforms produced have the same frequency as the carrier wave but with a varying amplitude based on the information from the modulating signal. AM is used extensively in communications and broadcast radio transmissions (Figure 3-8).

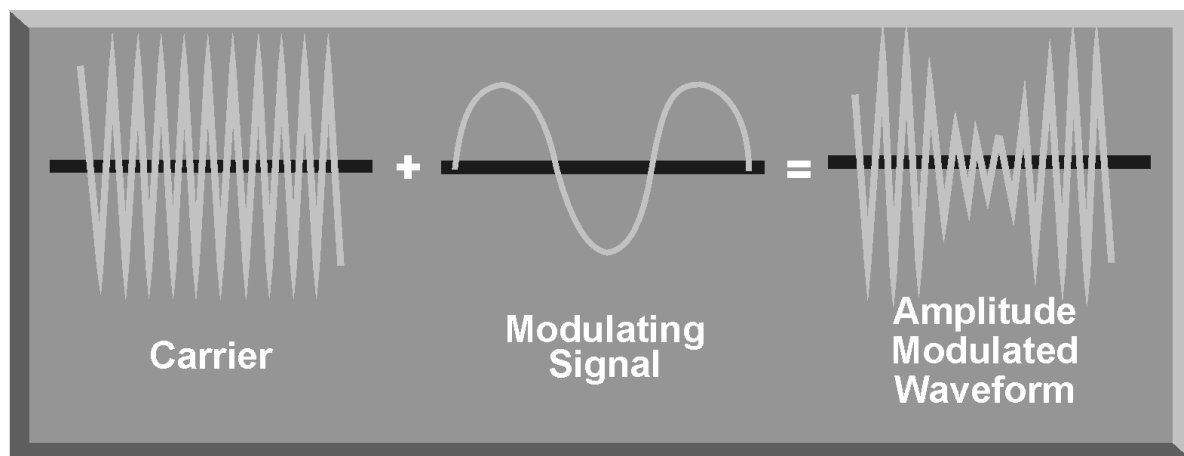

Figure 3-8. Amplitude Modulation

b. Frequency modulation (FM) is another means of impressing information on a carrier wave. Frequency modulation is accomplished by combining the carrier wave with a modulating signal containing information of varying frequency. The waveform produced has the same amplitude as the carrier wave, but the frequency varies based on the information from the modulating signal (Figure 3-9). FM is used extensively in communications and commercial radio. FM is also used with continuous wave (CW) radars to make them more resistant to jamming and to add range determination capability.

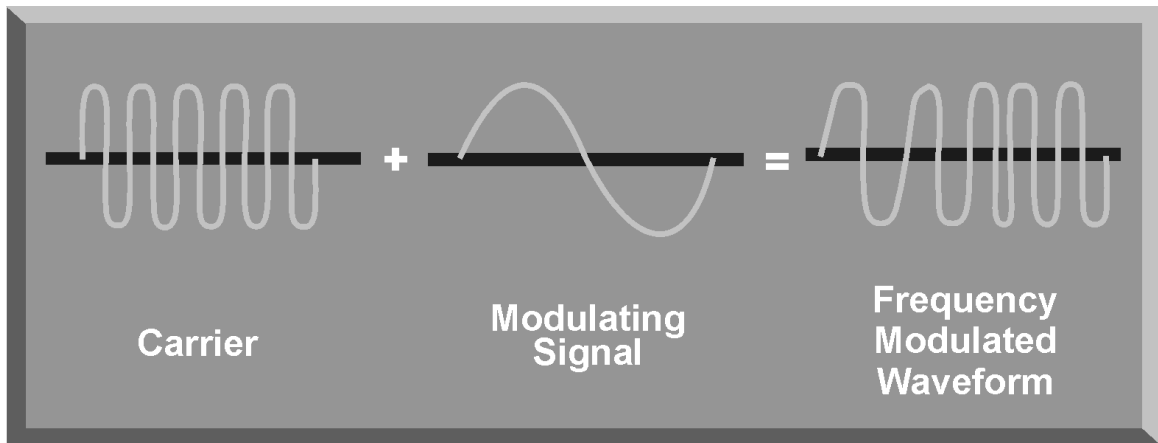

Figure 3-9. Frequency Modulation

c. A type of amplitude modulation known as pulse modulation (PM) is used in pulse radars to produce the short, powerful bursts of RF energy. PM combines the carrier wave with a rectangular pulse that acts like a switch. PM turns the transmitter on, leaves it on for a predetermined time, and then turns it off. The result is a waveform that produces radar pulses that can be used to measure range and angle to the target (Figure 3-10).

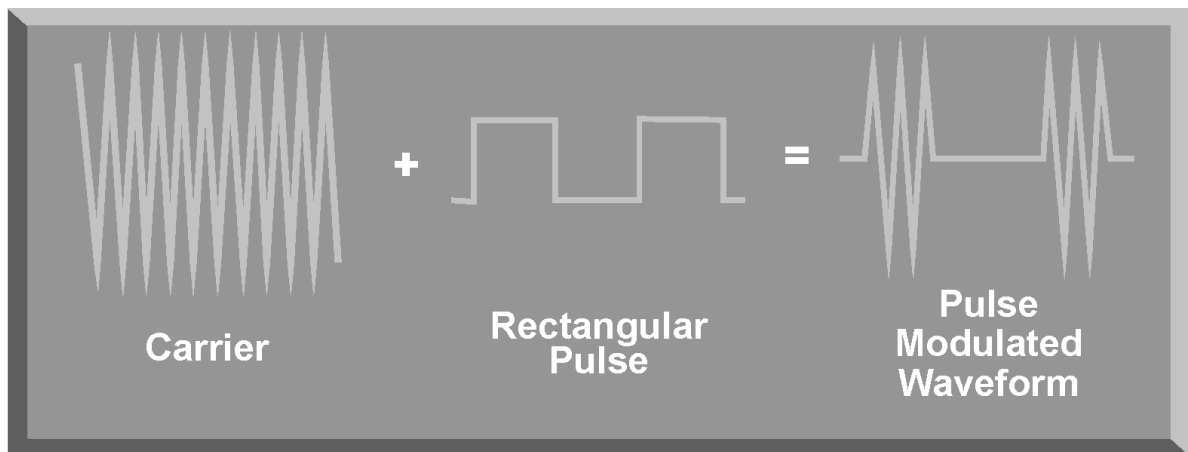

Figure 3-10. Pulse Modulation

10. SUMMARY

The radar signal characteristics of PW, PRI, PRF, and power determine the maximum range and the range resolution capability of a specific radar. When combined with the frequency of the carrier wave of the radar signal, these parameters provide a unique signature to identify a specific radar signal. Modulation is the method used to put information on an RF carrier wave. The primary modulation techniques used in radar signal generation include amplitude, frequency, and pulse modulation. The radar signal characteristics of PRF, PRI, power, and modulation are the keys to understanding radar operation and jamming techniques.

CHAPTER 4. RADAR SYSTEM COMPONENTS

1. INTRODUCTION

The individual components of a radar determine the capabilities and limitations of a particular radar system. The characteristics of these components also determine the countermeasures that will be effective against a specific radar system. This chapter will discuss the components of a basic pulse radar, a continuous wave (CW) radar, a pulse Doppler radar, and a monopulse radar.

2. PULSE RADAR SYSTEM

The most common type of radar design is the pulse radar system. The name describes a process of transmitting discrete bursts of RF energy at the frequency of the radar system. The time that pulses are transmitted determines the pulse repetition frequency (PRF) of the radar system. A pulse radar system can figure out range and azimuth. Range is determined by the time that it takes a pulse to go to a target and return. Target azimuth is determined by the relative position, or antenna orientation, when the pulse strikes the target. Figure 4-1 is a basic block diagram of a simple pulse radar system.

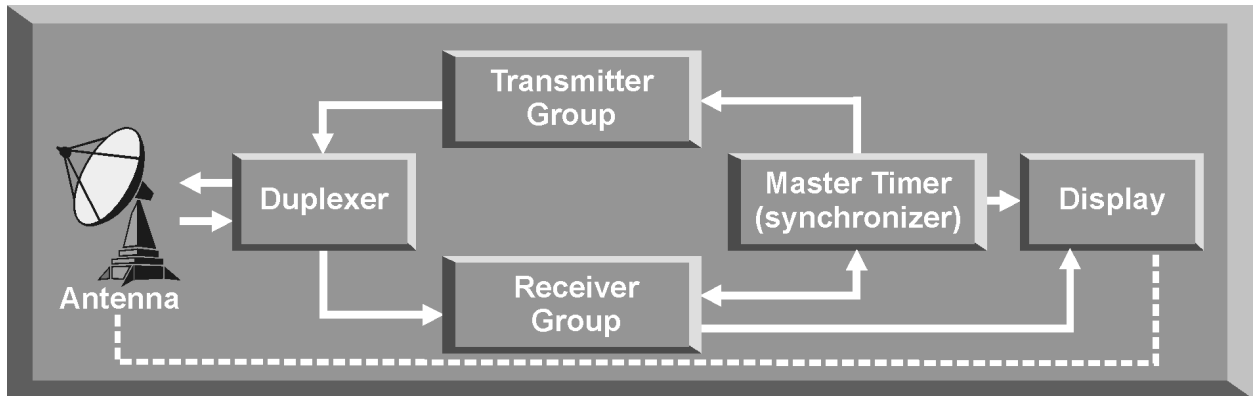

Figure 4-1. Pulse Radar Block Diagram

a. The purpose of the transmitter is to deliver a series of high-energy bursts of radio frequency (RF) energy to the antenna. The transmitter group of a modern pulse radar normally consists of a pulse generator or waveform generator, a modulator, and some kind of power amplifier (Figure 4-2).

(1) The purpose of the waveform generator is to generate the proper waveform or pulse, normally at a low power level, before delivery to the modulator. It is much easier to generate complex waveforms at a lower power level. These complex waveforms are required for coherent systems employing digital moving target indicator techniques and for pulse Doppler radar operations.

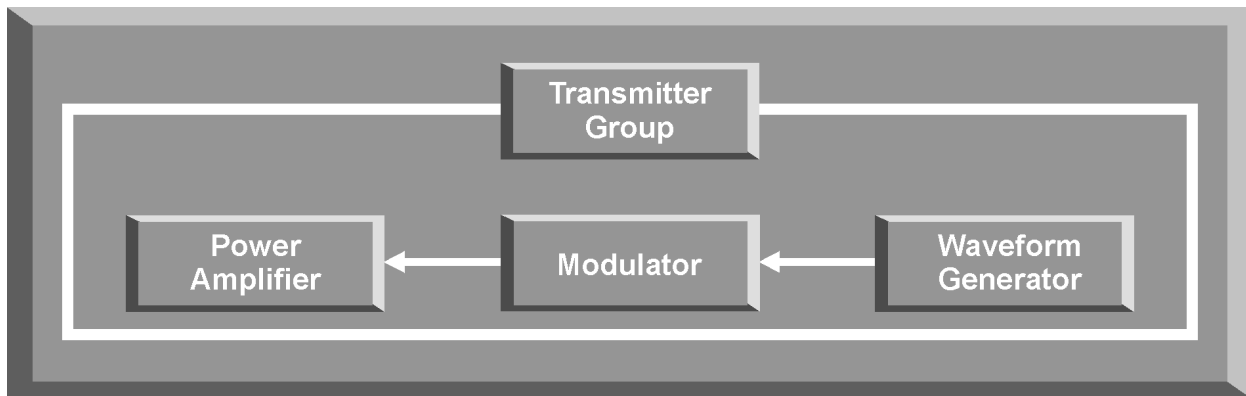

Figure 4-2. Transmitter Group

(2) The modulator is a major portion of the transmitter. The modulator provides an extremely powerful, very short pulse of direct current (DC) voltage to the power amplifier. This is similar to the ignition system of an automobile but with very stringent requirements. The modulator has an energy storage device and a switch. Between pulses, during the resting time of the transmitter, energy is accumulated and stored in the storage device. When keyed by the master timer, all this energy is switched to the power amplifier as a pulse. The waveform of this pulse is determined by the waveform generator.

(3) The power amplifier for a modern radar is normally a klystron, traveling wave tube, cross field amplifier, or solid state amplifier. Most common pulse radars use a klystron power amplifier. No matter what power amplifier is used, the purpose of the transmitter group is to produce a series of pulses at the correct amplitude, at the proper interval, with the exact waveform, and at the operating frequency of the radar.

b. A duplexer is required when both the transmitter and receiver use the same antenna. The duplexer acts as a rapid switch to protect the sensitive receiver from damage when the high-power transmitter is on. When the transmitter is off, the duplexer directs the weak target signals to the receiver. The duplexer's main purpose is to minimize power loss and maximize isolation. Power lost in the duplexer during transmission reduces the maximum detection range of the radar. Isolation refers to the amount of transmitter power that “bleeds through” the duplexer to the receiver during transmission. This “bleed through” must be extremely small to avoid receiver saturation or damage.

c. The capabilities of the receiver group are critical to radar performance (Figure 4-3). The ability of the radar receiver to detect the presence of the target return and extract the required information is limited primarily by noise. Noise can enter the receiver through the antenna along with the target return. This type of noise is called external noise. Noise generated within the receiver is called thermal noise. Radar noise can never be completely eliminated. Minimizing noise

is the most important consideration in the design of the sensitive receivers used with modern radars. In addition, relative immunity to noise makes a radar system more resistant to jamming.

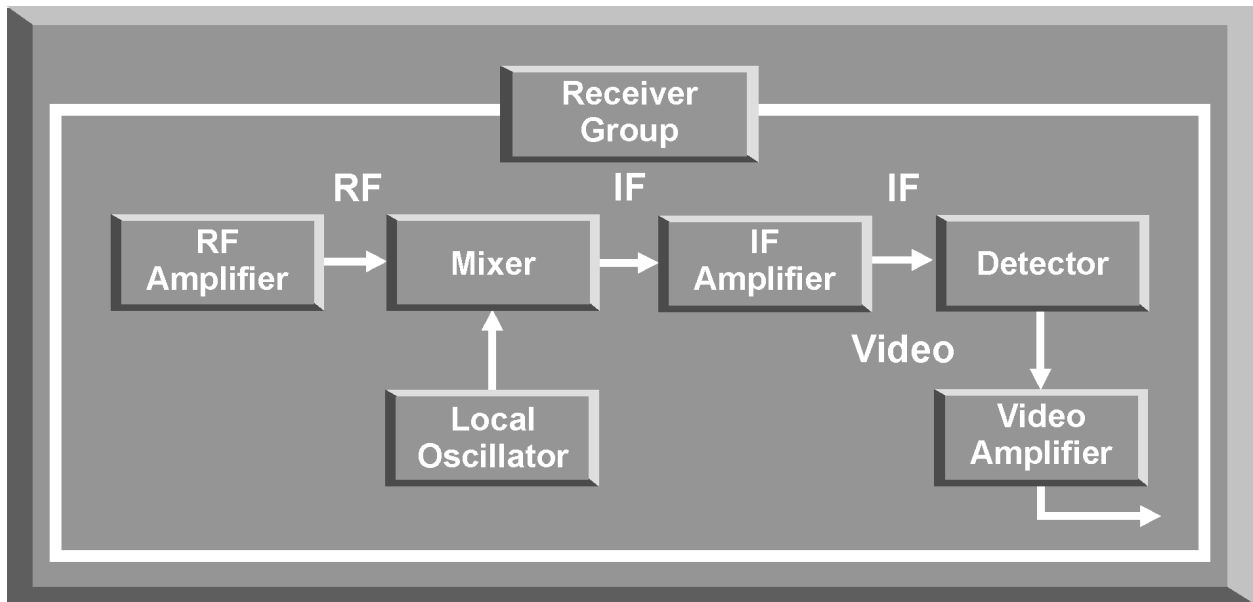

Figure 4-3. Receiver Group

(1) The most common pulse radar receiver is the superheterodyne receiver. A superheterodyne receiver consists of an RF amplifier, a mixer and local intermediate frequency (IF) amplifier, a detector, and a video amplifier.

(2) Radar target returns enter the receiver group via the antenna and duplexer. Since these signals are normally very low power, the RF amplifier boosts the signal gain and filters out as much external noise as possible. The capability of the RF amplifier to minimize noise determines the receiver sensitivity. The boosted RF signal is sent to the mixer where it is converted to a lower IF. This is accomplished by mixing the RF signal with the signal from the local oscillator to produce an IF that is easier to process. The IF amplifier increases the IF signal level and includes a matched filter. The matched filter maximizes the signal-to-noise ratio which enhances detection of the target return. The detector, which is usually a crystal diode, extracts the video modulation from the IF or converts the IF to a video signal.

d. The brain of a basic pulse radar is the master timer, or synchronizer, which coordinates the operation of the various parts of the radar (Figure 4-4). Exact timing within the radar is necessary to get accurate range. The master timer is an oscillator that triggers the transmitter to initiate transmission of a pulse. Simultaneously, the master timer sends a signal to initialize the display to ensure that range and azimuth information is accurately displayed.

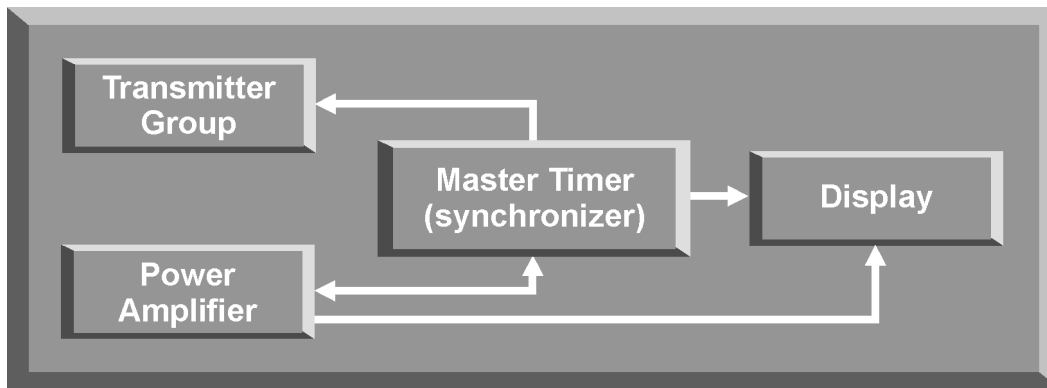

Figure 4-4. Master Timer/Synchronizer

e. The function of the antenna during transmission is to concentrate the radar energy from the transmitter into a shaped beam that points in the desired direction (Figure 4-5). During reception, or listening time, the function of the antenna is to collect the returning radar energy contained in the echo signals, and deliver these signals to the receiver. Radar antennas are characterized by directive beams that are usually scanned in a recognizable pattern.

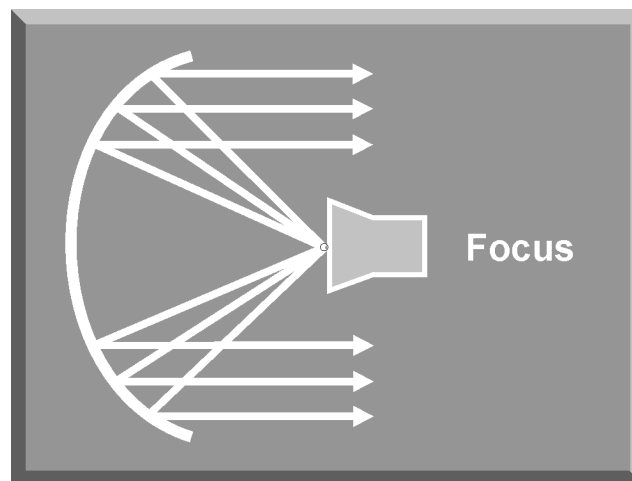

Figure 4-5. Parabolic Antenna

f. The purpose of the radar display is to take the information derived from a radar target in the receiver group and present it to the operator in a usable format. There are many different types of scope displays depending on the purpose of the radar and how the radar information is to be used. There are four basic types of radar displays: the A scope, B scope, range height indicator (RHI) scope, and plan position indicator (PPI) scope.

(1) The A scope is used to display target range or velocity (Figure 4-6). Threat systems using A scope displays include air interceptors (AIs) with range-only radar, surface-to-air missiles (SAMs), and radar-directed anti-aircraft artillery (AAA) systems. SAM and AAA systems may use the A scope for range or velocity information, and other radar displays for azimuth and elevation data. The A scope displays range or velocity in relation to amplitude. The operator must distinguish the target return from other returns, including ground return and noise.

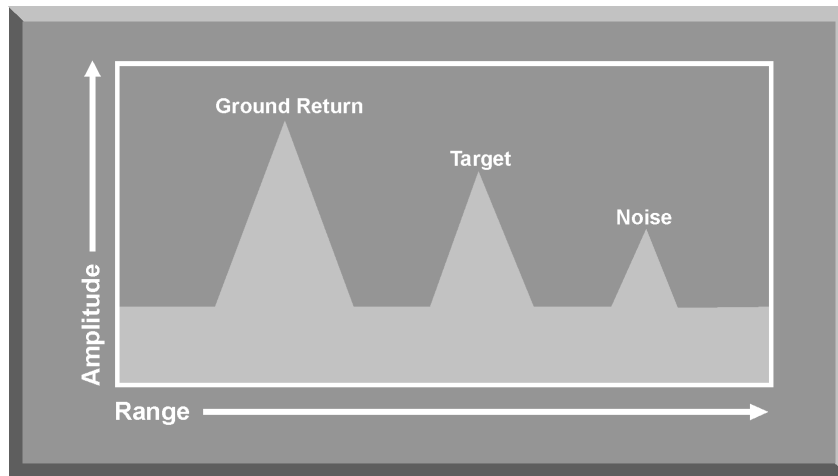

Figure 4-6. A Scope Display

(2) The B scope is used to display target range and azimuth (Figure 4-7). Threat systems using B scope displays include AI and SAM systems. The position of the target return to the right or left of the centerline of the screen shows the azimuth of the target. The position of the target return in relation to the bottom of the display, or zero range, shows target range.



Figure 4-7. B Scope Display

(3) The RHI scope is used to display range and elevation (Figure 4-8). The RHI scope is used with height finder radars, and a modified RHI scope is used for ground-controlled approach (GCA) radars. The sweep trace of the display produces a fan-shaped display with the vertex at the lower left of the scope. The antenna sweeps up and down and is synchronized with the display.

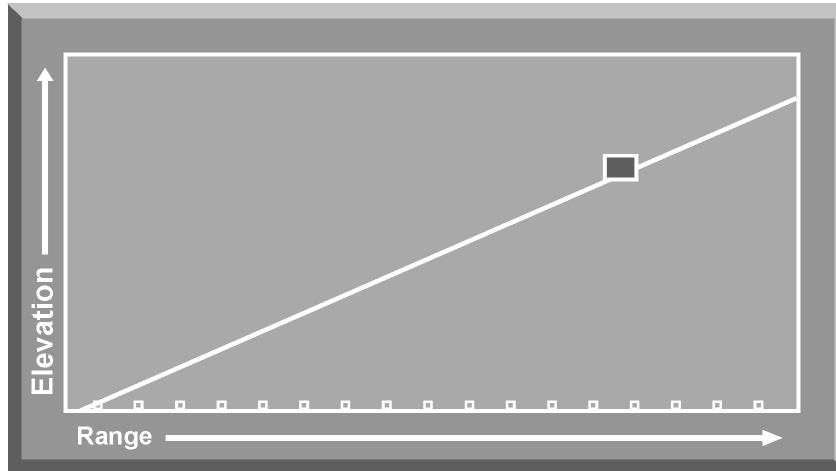

Figure 4-8. RHI Scope Display

(4) The PPI display is probably the best known radar display (Figure 4-9). The display represents a map picture of the area scanned by the radar beam, usually 360 degrees. The PPI display is used by early warning, acquisition, ground-controlled intercept (GCI), and SAM radar systems. The target return's angular position shows target azimuth, while distance from the center of the display shows range.

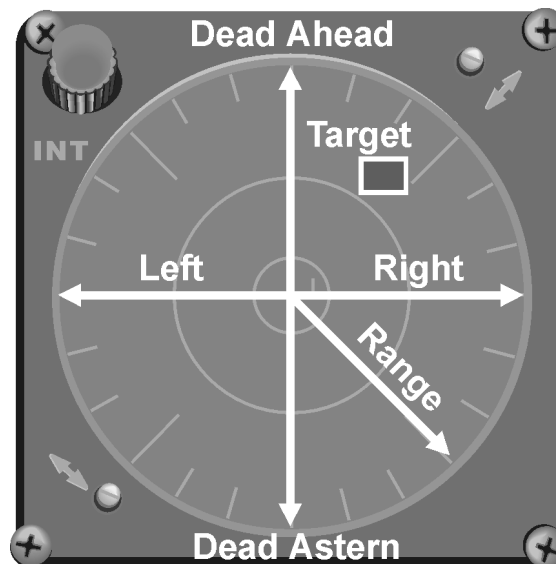

Figure 4-9. PPI Scope Display

3. CONTINUOUS WAVE (CW) RADAR

A continuous radar transmission from the antenna requires that classic CW radars have two antennas, one for transmission and one for reception (Figure 4-10). Since a continuous transmission results in a continuous echo signal, it is impossible to tell what part of the echo is associated with any particular part of the transmission. This makes conventional range determination (based on timing) impossible. However, the simple application of the Doppler principle provides a means for a CW radar to track a target. The Doppler principle deals with the fact that a radar return from a moving target will be shifted in frequency by an amount proportional to its radial velocity relative to the radar site. Using the difference in frequency from the transmitted signal to the received signal, a CW radar can separate the target return from clutter, based on a change in frequency. This type of radar is called a CW Doppler radar.

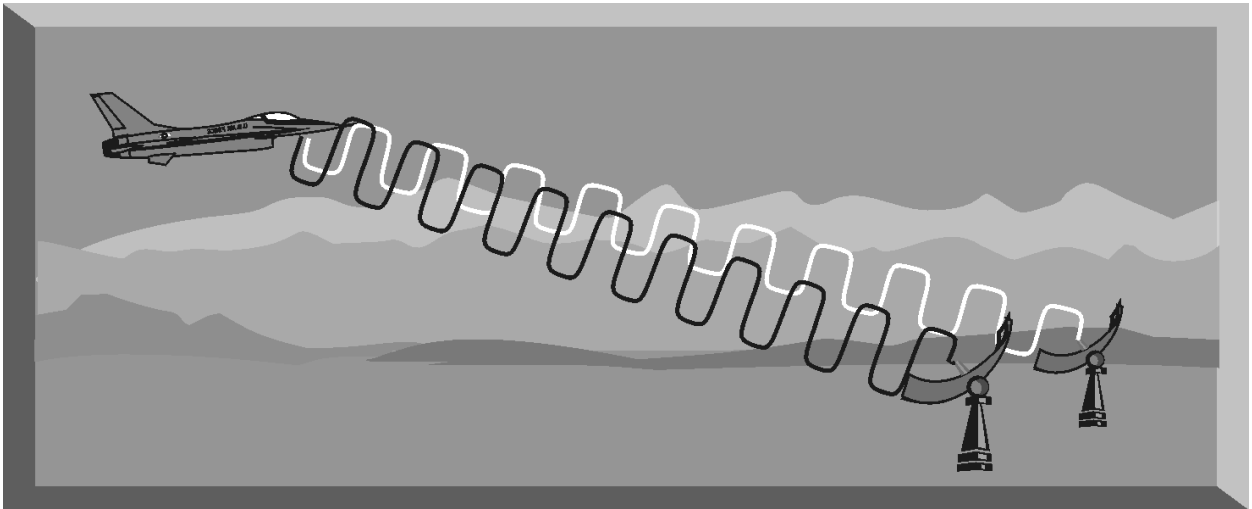

Figure 4-10. Continuous Wave Radar

a. Figure 4-11 depicts a basic CW Doppler radar. In a simple CW Doppler radar, the transmitter transmits a continuous signal at the radar's operating frequency. This signal is reflected by a moving target and travels back to the receiving antenna. The frequency of the reflected signal (f_d) is the frequency change due to the Doppler effect. This target frequency is passed to the detector. The transmitted frequency (f_o) is also fed to the detector as a reference. The detector notes the difference between the transmitted and received frequencies and passes this frequency to the Doppler filters. The Doppler filters only allow Doppler frequencies within a certain range to pass through. A filter is required for each Doppler frequency. The number of Doppler filters determines the number of targets that the radar can resolve in velocity.

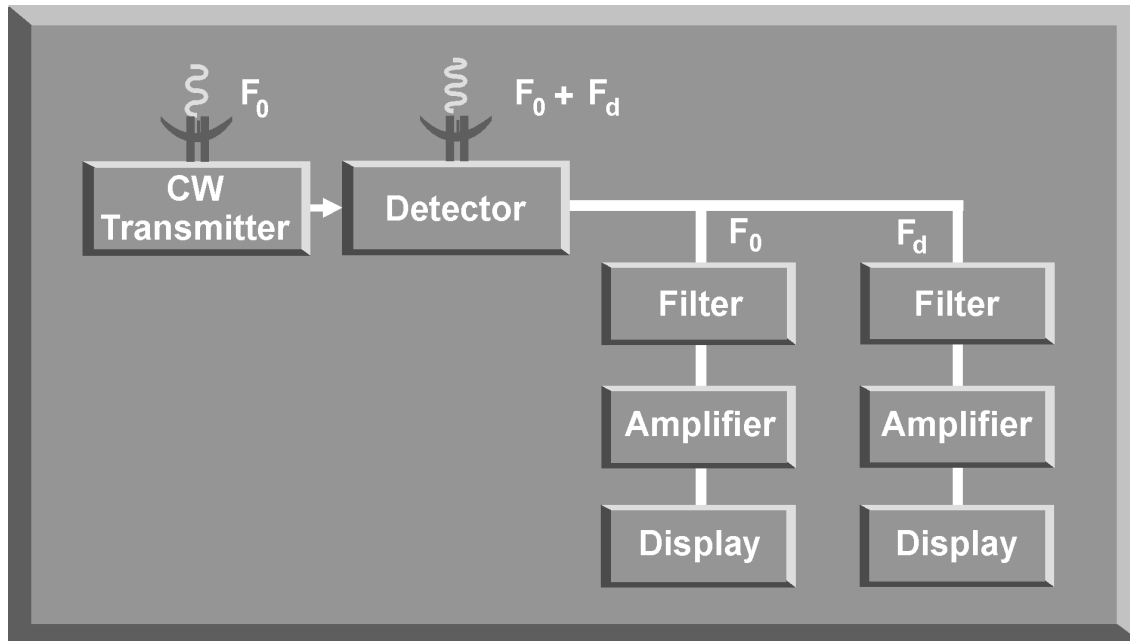

Figure 4-11. Basic CW Doppler Radar

b. The output of each Doppler filter is amplified and passed to its own display. The display is normally an A scope as shown in Figure 4-12.

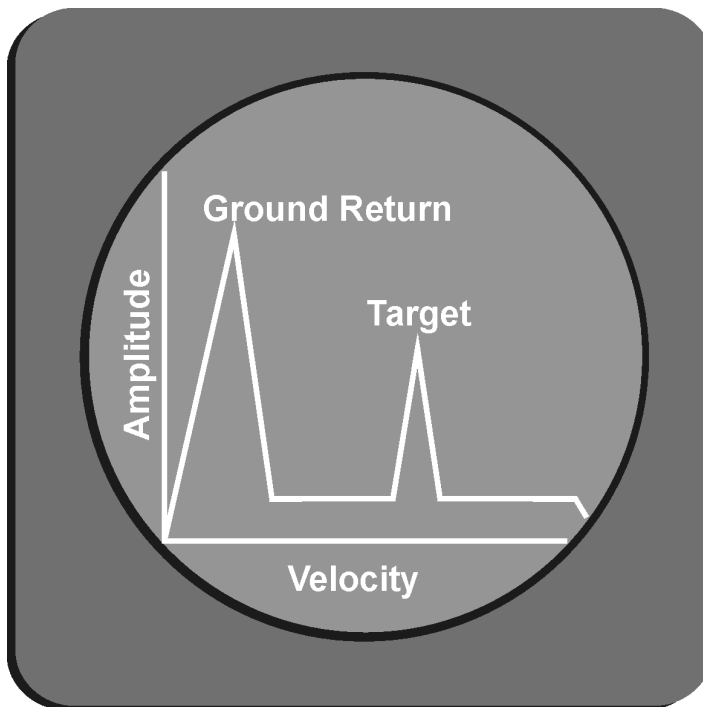

Figure 4-12. CW Doppler Radar Display

4. PULSE DOPPLER RADAR

Pulse Doppler radars combine the advantages of both pulse and Doppler radar systems (Figure 4-13). Because the signal is pulsed, the radar can determine range, azimuth, and elevation, similar to a conventional pulsed radar. A pulse Doppler radar can also compute overtake, or rate of closure, relative to the radar system on a pulse-to-pulse basis. Pulse Doppler radars also use multiple PRFs to eliminate target eclipsing and for range determination in medium PRF. The beauty of a pulse Doppler radar is that it eliminates ground clutter and provides range, azimuth, and velocity resolution.

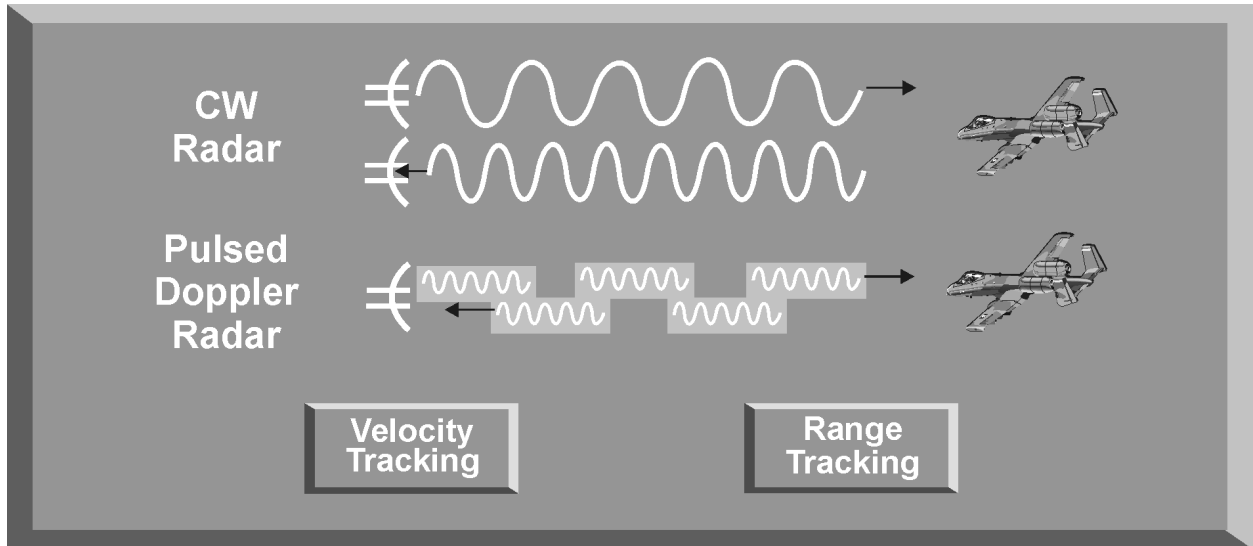

Figure 4-13. CW and Pulse Doppler Radar Comparison

a. A pulse Doppler radar transmits a box, or pulse, of coherent RF energy at the operating frequency of the radar. The frequency inside these boxes reacts the same way as the continuous waves of a CW radar. However, since the RF waves are pulsed, range determination can be accomplished by measuring the time it takes for the reflected pulse to return from the target. Velocity determination and tracking are accomplished by capturing and quantifying the Doppler shift of the frequencies in each box or pulse.

b. The basic block diagram of a coherent pulse Doppler radar (Figure 4-14) is similar to a pulse radar except for the addition of an exciter, a radar computer, and a digital signal processor. The exciter generates a continuous stable low power signal at the desired frequency and phase for the transmitter. It also sends this signal as a reference to the receiver. The digital signal processor performs the adding and subtracting functions required to find, track, and sort targets with respect to velocity and range. The radar computer performs all routine functions of the radar such as changing modes and accounting for aircraft flight parameters.

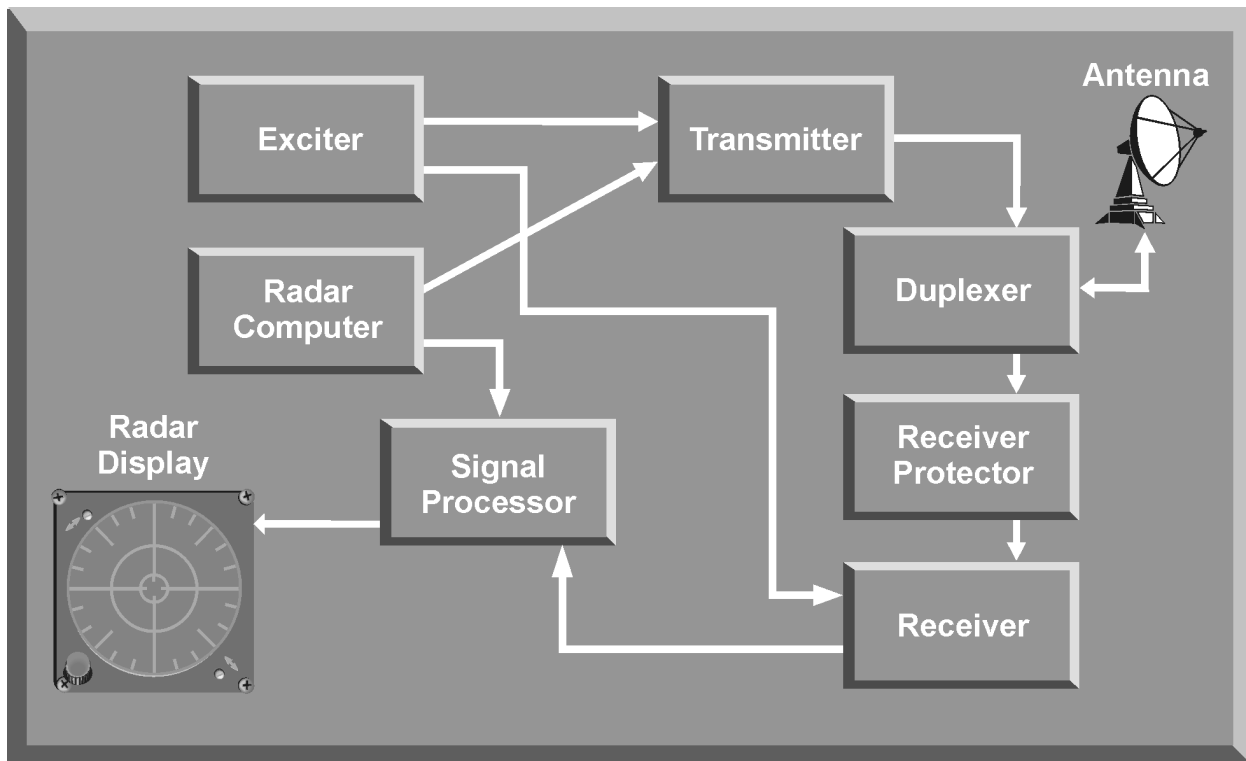

Figure 4-14. Basic Pulse Doppler Radar Diagram

5. MONOPULSE RADAR

The primary functions of monopulse radars include target tracking and weapon guidance. Monopulse radars were developed to overcome the limitations and jamming susceptibility of scanning radar systems. A monopulse radar typically receives returned radar energy in two, three, or four separate receivers, or channels, each looking at a different area. By comparing the returns from each receiver, track errors can be determined. For example, in Figure 4-15, this radar compares the amplitude, or signal strength, in each channel. Obviously, an aircraft in area "A" will produce a stronger return in receiver "A" since that receiver is focused in that direction. Since this type of system uses signal strength to determine position, typical noise jamming will only highlight an aircraft" position. Other coherent radars can measure phase differences versus the amplitude differences used in the last example. If a signal is directly ahead of the antenna, each quadrant will receive the returned signal at exactly the same time and therefore the same exact phase. However, if a return is off-center, the returned signal will strike part of the antenna slightly ahead of the opposite side and each quadrant will measure a different phase. This phase difference is used to determine azimuth error.

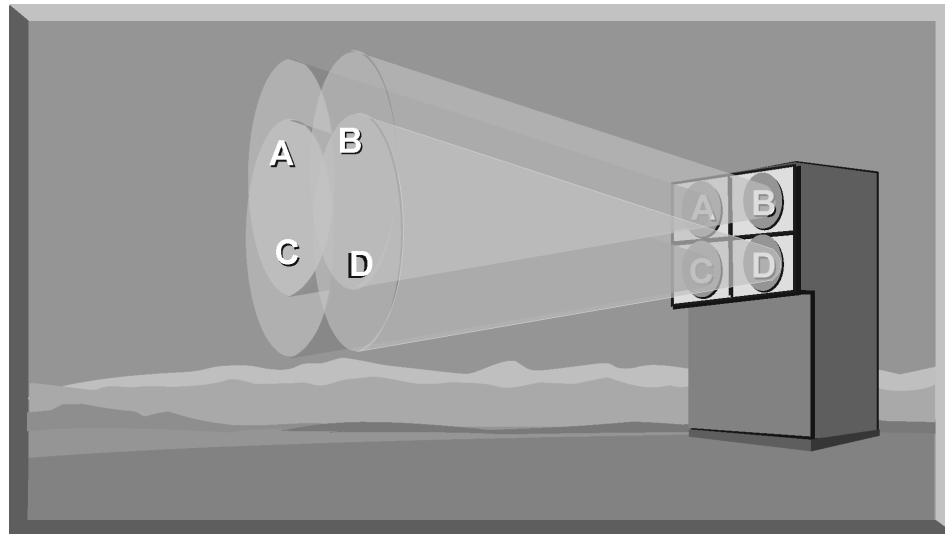

Figure 4-15. Monopulse Radar

a. Monopulse radars operate by comparing the amplitude or the phase of the received signal in each of the transmitted beams. A complex set of comparator circuits, called magic T's, do the addition and subtraction of the received signals based on the orientation of the magnetic field, or H-plane, and the electrostatic field, or E-plane (Figure 4-16). The received signal from antenna A enters the magic T in the H-plane arm while the signal from antenna B enters the magic T in the E-plane arm.

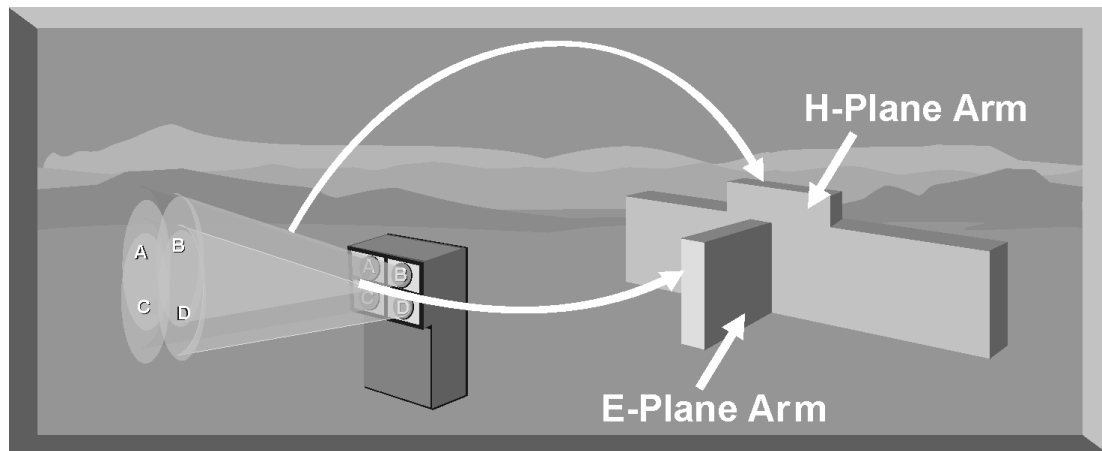

Figure 4-16. Monopulse Magic T's

b. Figure 4-17 depicts the output of a magic T. Output is the sum and difference of the two input signals. These sum and difference values, in amplitude or phase, are used to generate azimuth and elevation error signals and to compute range.

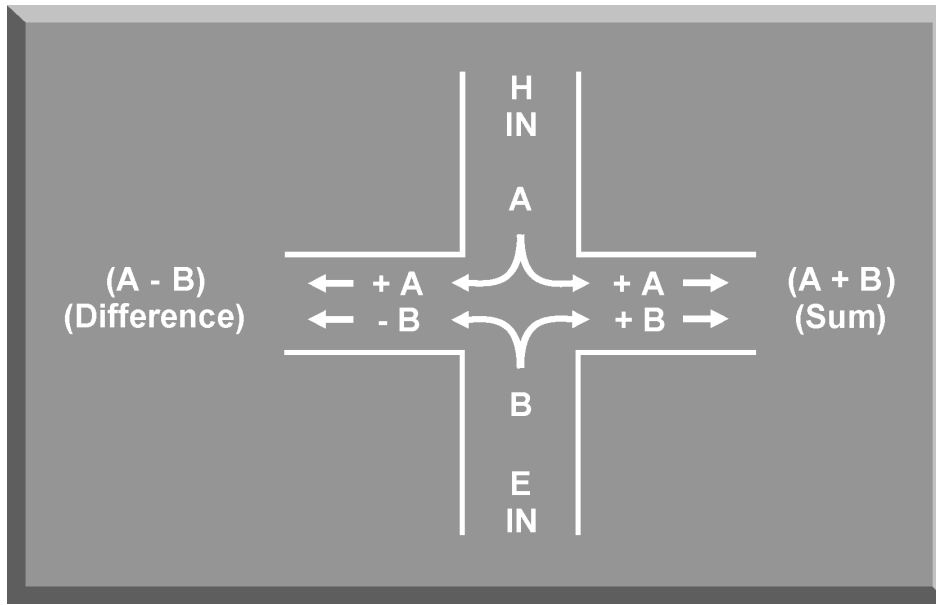

Figure 4-17. Magic T Output Signals

c. These sum and differences computed by the magic T's are sent as signals to the monopulse tracking servos to generate both azimuth and elevation corrections to keep the monopulse antenna centered on the target (Figure 4-18). Target range is computed by calculating the difference of signal transmission time with the reception time of the target echo. Range information is displayed to the operator for range tracking.

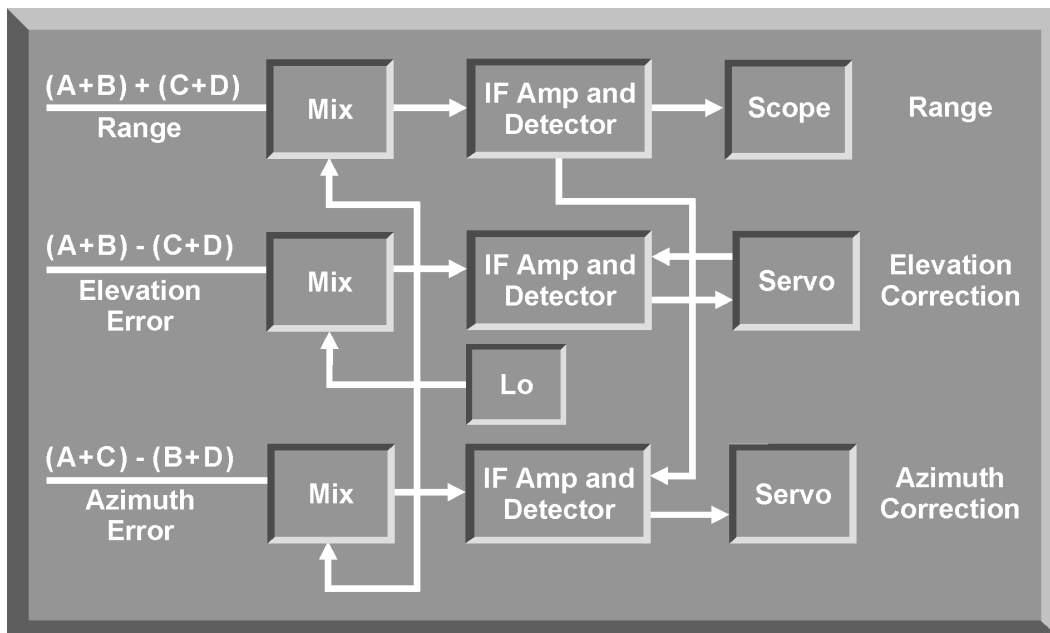

Figure 4-18. Monopulse Radar Track

d. If the signal in antenna A equals the signal in antenna B, equals the signal in antenna C, and equals the signal in antenna D, the target is in the center of the four radar beams (Figure 4-19). This is the condition the monopulse tracker attempts to maintain when tracking a target.

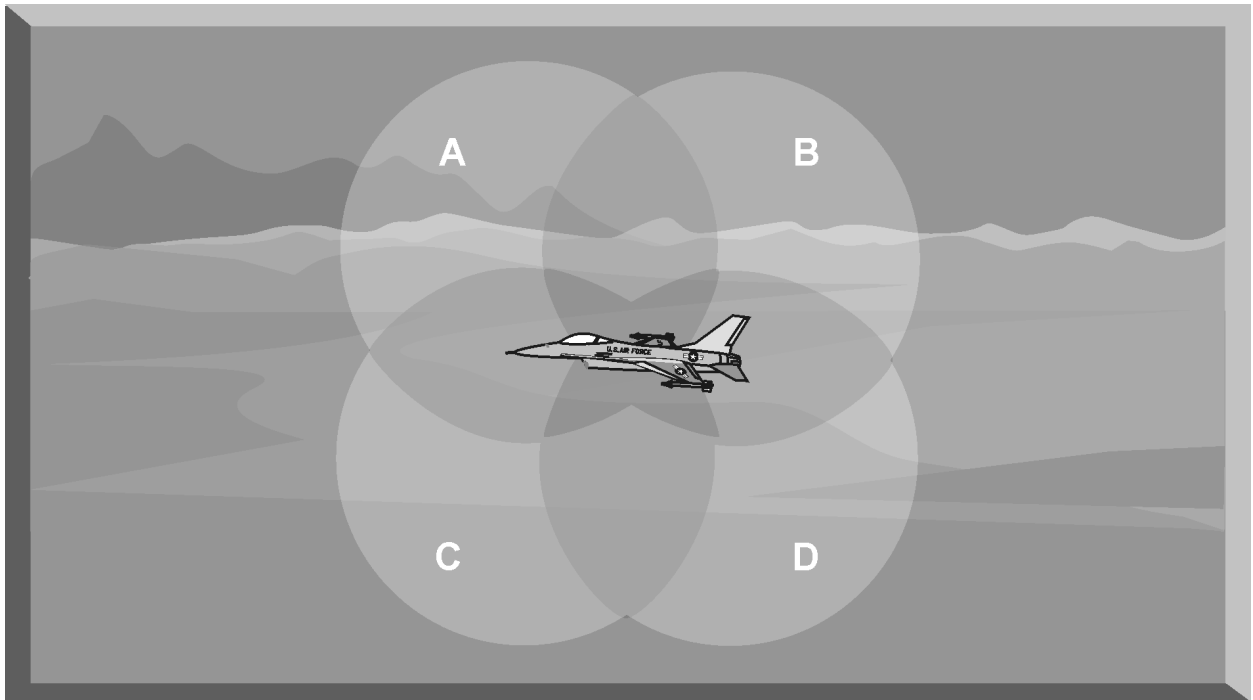

Figure 4-19. Monopulse Radar Track Logic

6. SUMMARY

This chapter has discussed the basic components of a simple pulse radar, a continuous wave radar, a pulse Doppler radar, and a monopulse radar. The characteristics of these components determine the capabilities and limitations of a particular radar system.

CHAPTER 5. RADAR PRINCIPLES

1. INTRODUCTION

The primary purpose of radar systems is to determine the range, azimuth, elevation, or velocity of a target. The ability of a radar system to determine and resolve these important target parameters depends on the characteristics of the transmitted radar signal. This chapter explains the relationship of radar frequency (RF), pulse repetition frequency (PRF), pulse width (PW), and beamwidth to target detection and resolution.

2. RADAR RANGE

A basic pulse radar system consists of four fundamental elements: the transmitter, the receiver, the antenna, and the synchronizer, or master timer.

a. The transmitter, through the antenna, sends out a pulse of RF energy at a designated frequency. The presence of a target is revealed when the RF energy bounces off the target, returns to the radar antenna, and goes into the receiver (Figure 5-1). The master timer measures the time between the transmission of a pulse and the arrival of a target echo.

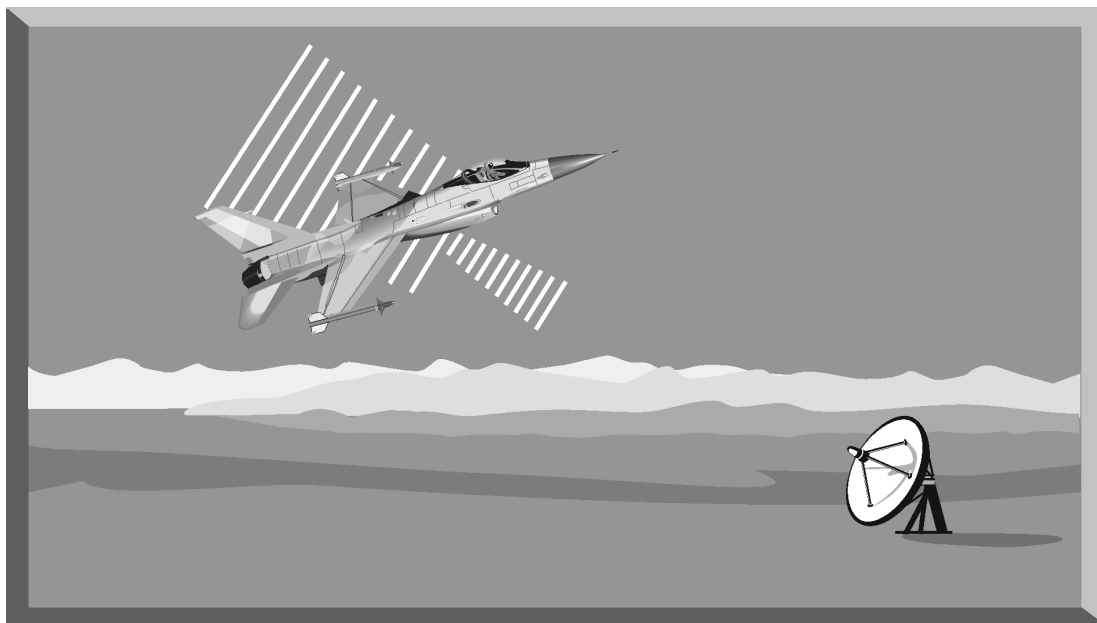

Figure 5-1. Basic Radar Pulse

(1) RF energy travels at the speed of light (c) which is 3×10^8 meters per second. Target range can be computed by using the basic radar range determination equation (Equation 5-1).

$$\text{Target Range} = \frac{\text{Measured Time} \times \text{Speed of Light (c)}}{2}$$

Equation 5-1. Basic Radar Range Determination Equation

(2) Another useful measurement is the radar mile, which is the round trip time for an RF wave to travel to and from a target one nautical mile away (Figure 5-2). Solving the radar range equation for time results in Equation 5-2. Substituting the appropriate values into the equation and solving for time gives measured time of 12.4 microseconds for a one nautical mile (1853 meters) round trip.

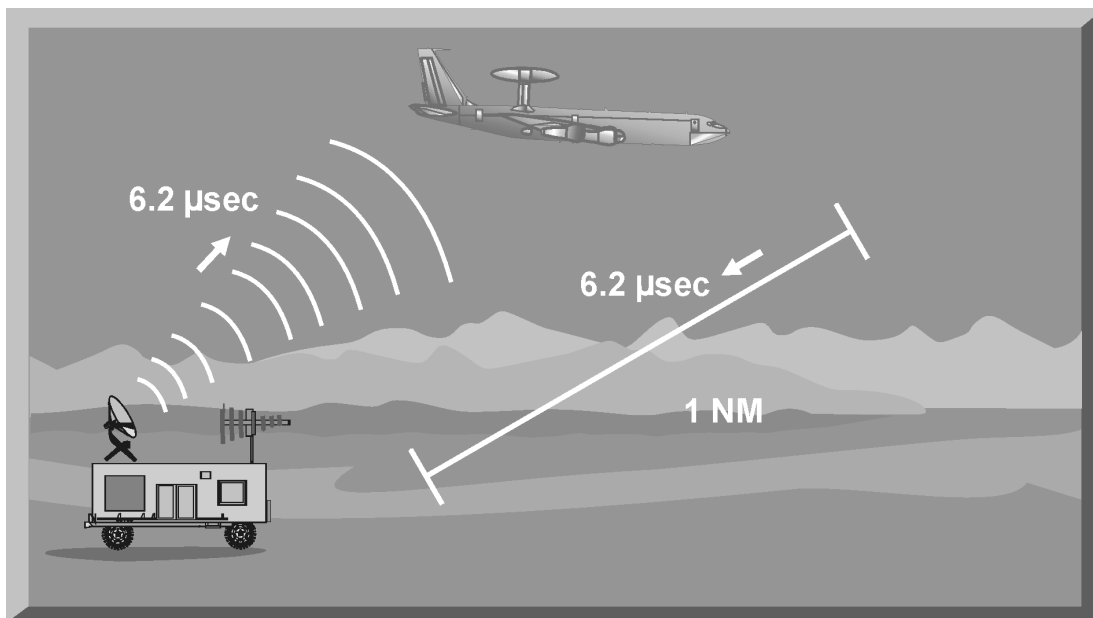

Figure 5-2. Radar Mile

$$\text{Measured Time} = \frac{\text{Target Range} \times 2}{\text{Speed of Light (c)}} = \frac{1853 \text{ meters} \times 2}{3 \times 10^8 \text{ meters/second}} = 12.4 \mu\text{sec}$$

Equation 5-2. Radar Mile

(3) A limitation on radar detection range is the concept of a second time around echo. A second time around echo occurs when a target echo associated with a particular radar pulse arrives at the antenna after another radar pulse has been transmitted. The radar master timer always assumes the target echo is associated with the last pulse transmitted. This makes the target echo ambiguous in range. Figure 5-3 depicts a radar signal with a pulse recurrence time (PRT) of 248 microseconds. Radar pulse A takes 372 microseconds to travel to the target and return. Using the range determination equation, actual target range is 30 nautical miles (nm). However, before the target echo returns to the antenna, radar pulse B is transmitted. The master timer associates the target echo of pulse A with radar pulse B, and calculates a target range of 10 nm. This ambiguous and false range is displayed to the operator.

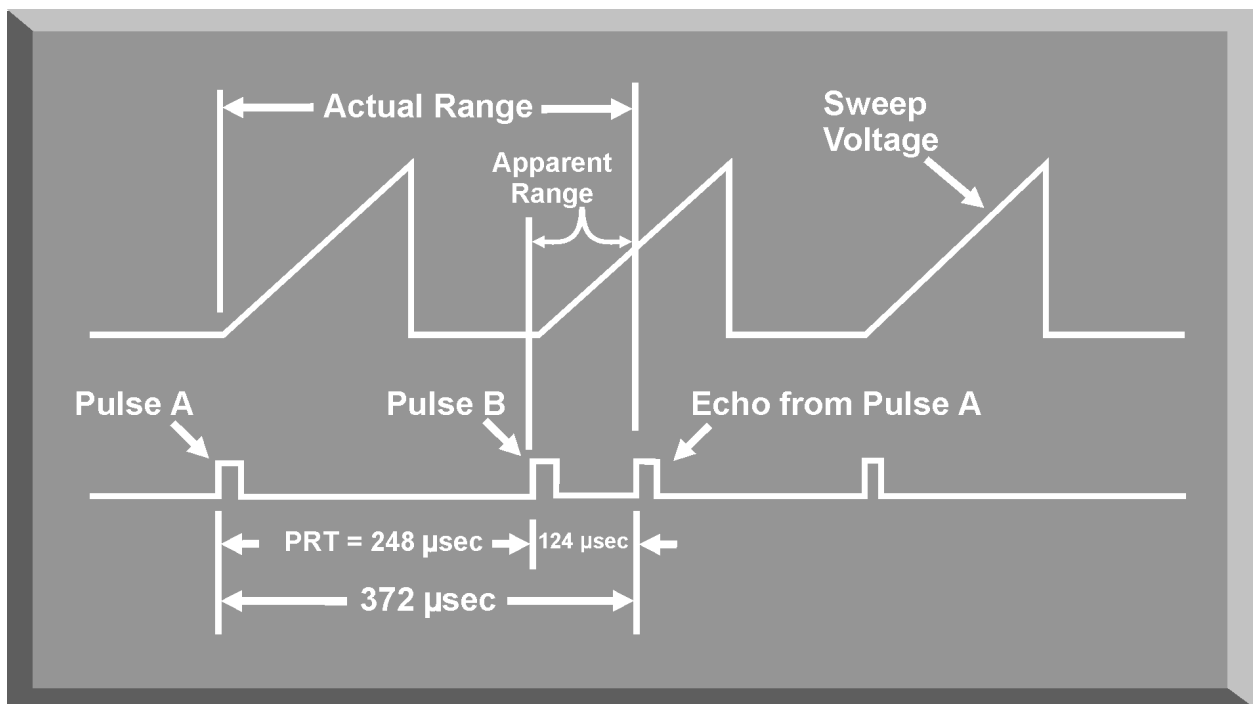

Figure 5-3. Second Time Around Echo

(4) Range ambiguities caused by second time around echoes limit the maximum unambiguous range of a radar system. This important capability can be calculated by using Equation 5-3. An analysis of this equation shows that a radar system designed for long-range detection should transmit a radar signal with a large PRT. In addition, as the PRF of a radar signal increases, the PRT decreases, and the maximum unambiguous range decreases.

$$\text{Maximum Unambiguous Range} = \frac{\text{PRT } (\mu\text{secs})}{12.4 (\mu\text{secs/nm})}$$

Equation 5-3. Maximum Unambiguous Range

b. A critical aspect of range determination is range resolution. Range resolution is the ability of a radar to separate two targets that are close together in range and are at approximately the same azimuth (Figure 5-4). The range resolution capability is determined by pulse width. Pulse width is the time that the radar is transmitting RF energy. Pulse width is measured in microseconds.

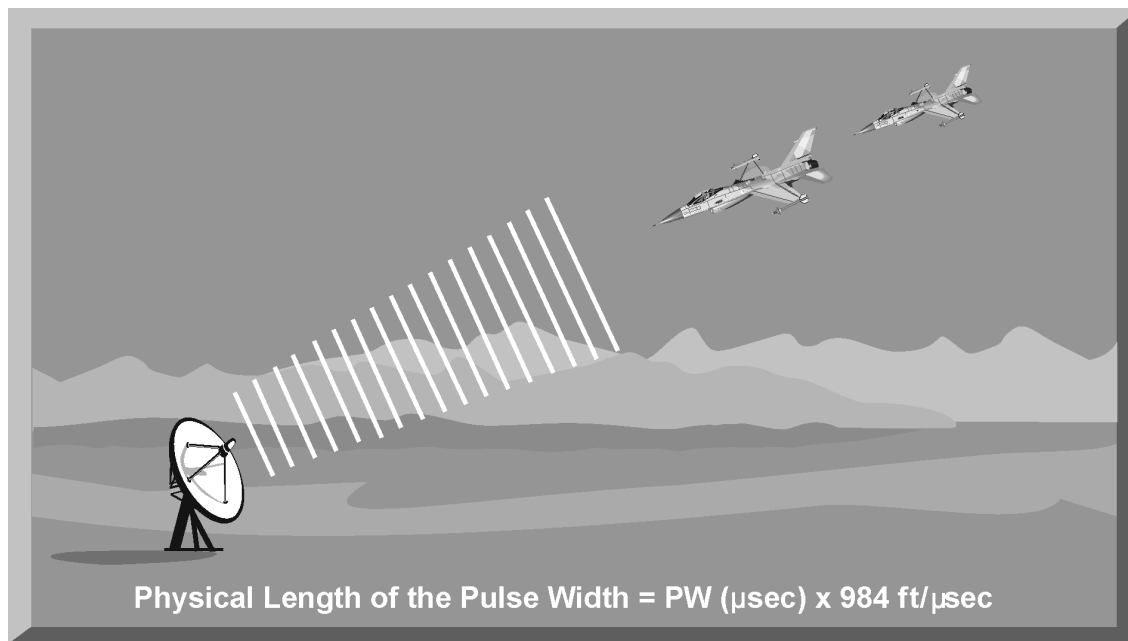

Figure 5-4. Radar Pulse

(1) A radar pulse in free space occupies a physical distance equal to the pulse width multiplied by the speed of light, which is about 984 feet per microsecond. If two targets are closer together than one-half of this physical distance, the radar cannot resolve the returns in range, and only one target will be displayed.

(2) To illustrate range resolution, consider Figure 5-5, in which two aircraft are separated by a distance of one-half the pulse width or less. At T1, the leading edge of the radar pulse hits the lead aircraft.

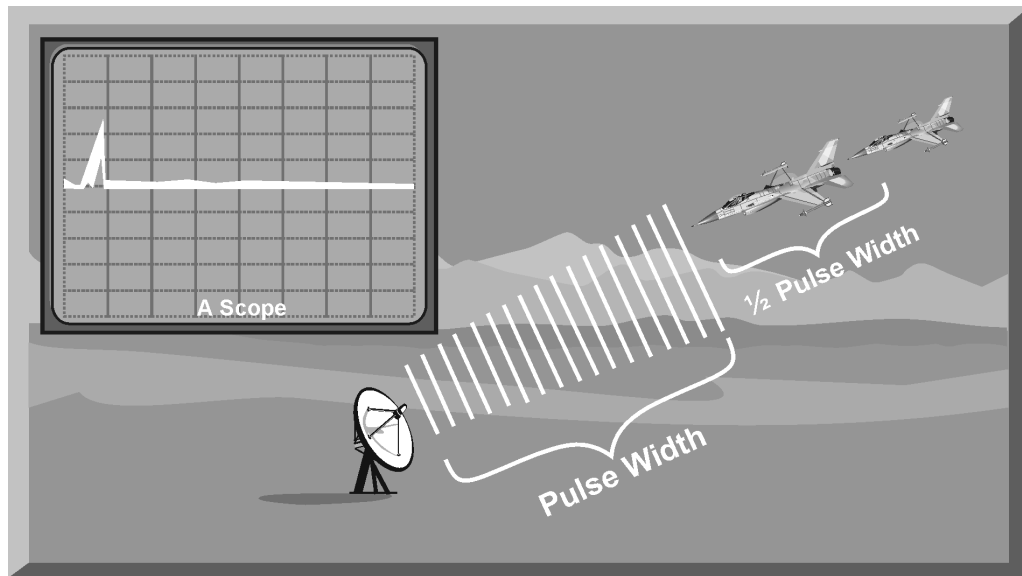

Figure 5-5. Radar Pulse at T1

(3) In Figure 5-6, at T2 the leading edge of this same pulse hits the trailing aircraft. Since the trailing aircraft is less than one-half the pulse width from the lead aircraft, the return echo from the lead aircraft is received by the antenna before the entire pulse has left the trailing aircraft.

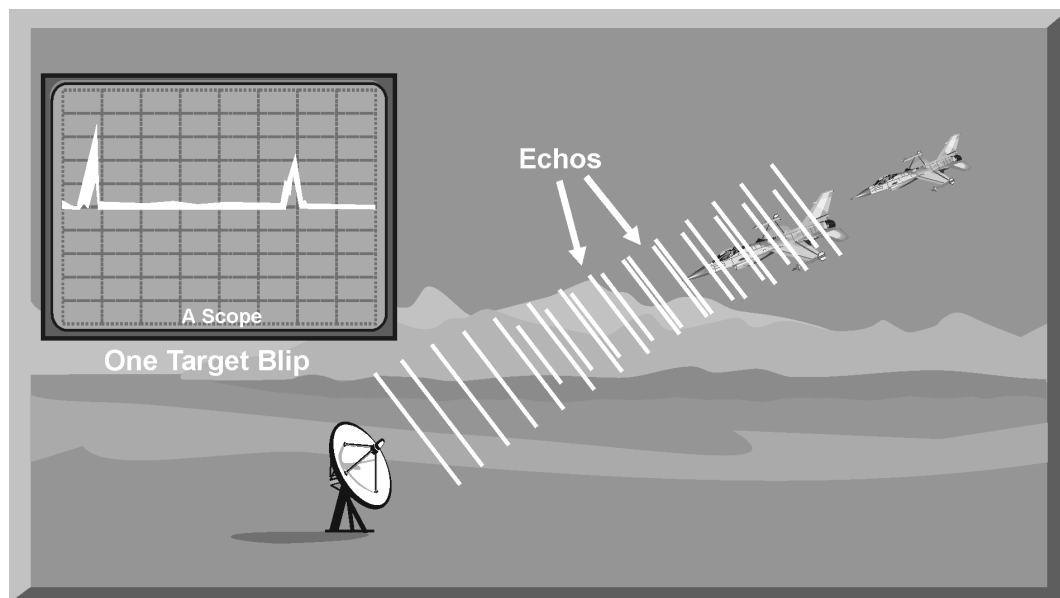

Figure 5-6. Radar Pulse at T2

(4) T3 depicts the merging target echoes at the radar (Figure 5-7). The radar would display only one target in this situation, such as the one shown on the radar scope in Figure 5-6.

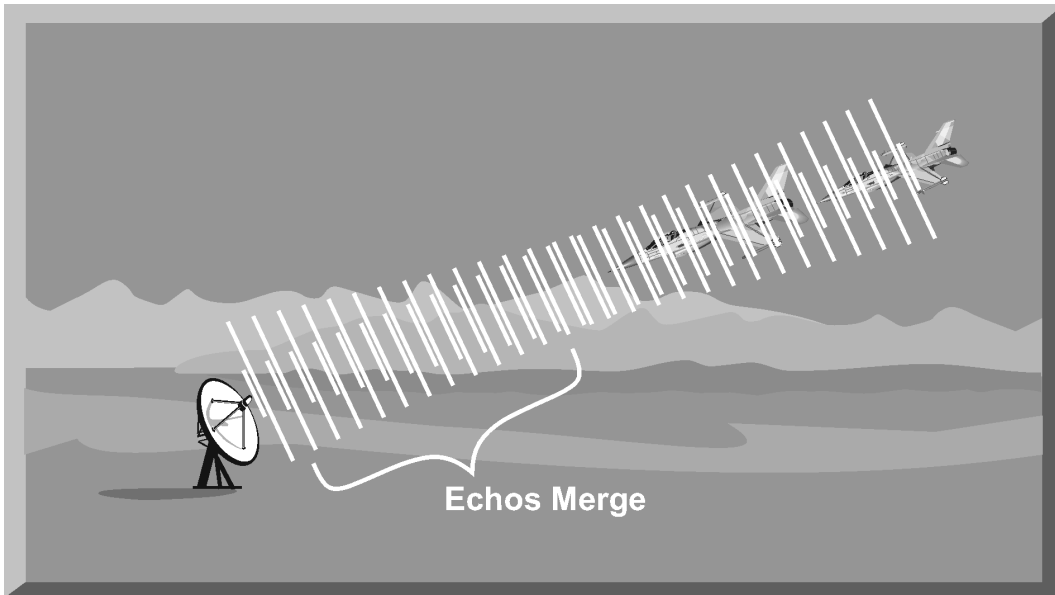

Figure 5-7. Radar Pulse at T3

(5) Two targets separated by more than one-half the pulse width, as in Figure 5-8, will be displayed as two targets. In this case, the transmitted pulse is completely past the lead aircraft before the return echo from the trailing aircraft reaches the antenna.

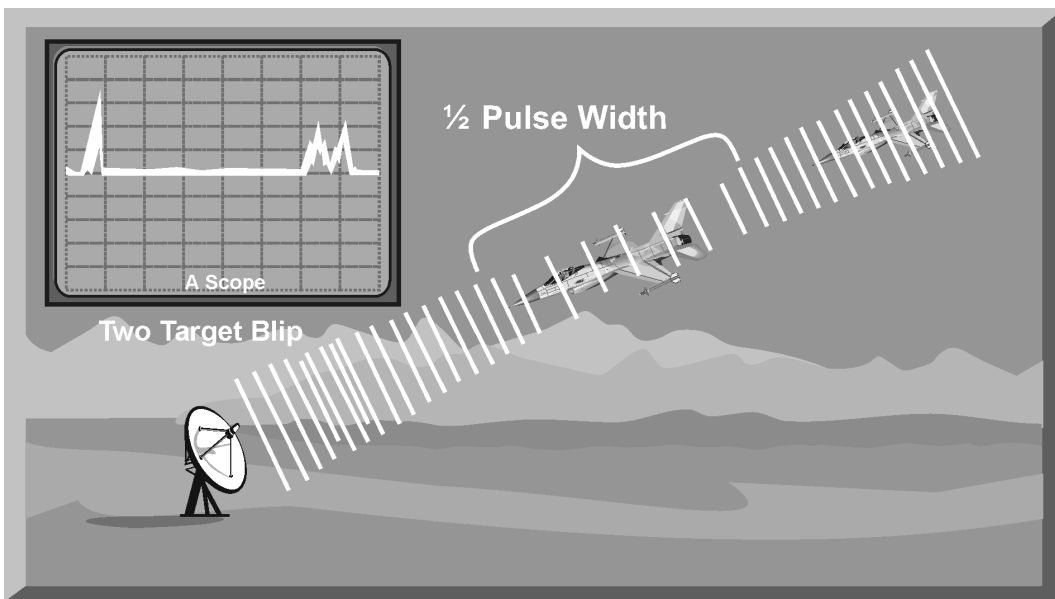

Figure 5-8. Radar Range Resolution

(6) The range resolution of the radar is usually expressed in feet and can be computed using Equation 5-4. It is the minimum separation required between two targets in order for the radar to display them separately on the radar scope.

$$\text{Range Resolution} = \frac{\text{Pulse Width} \times 984 \text{ feet}}{2}$$

Equation 5-4. Range Resolution

3. AZIMUTH DETERMINATION

The beamwidth of a radar system is the horizontal and vertical thickness of the radar beam (Figure 5-9). Beamwidth depends on antenna design and is normally measured in degrees from the center of the beam to the point at which the power drops off by half. This half-power point is -3 dB in power drop-off. Beamwidth governs the azimuth and elevation accuracy and resolution capability of a radar system in the same way that pulse width governs radar range accuracy and resolution.

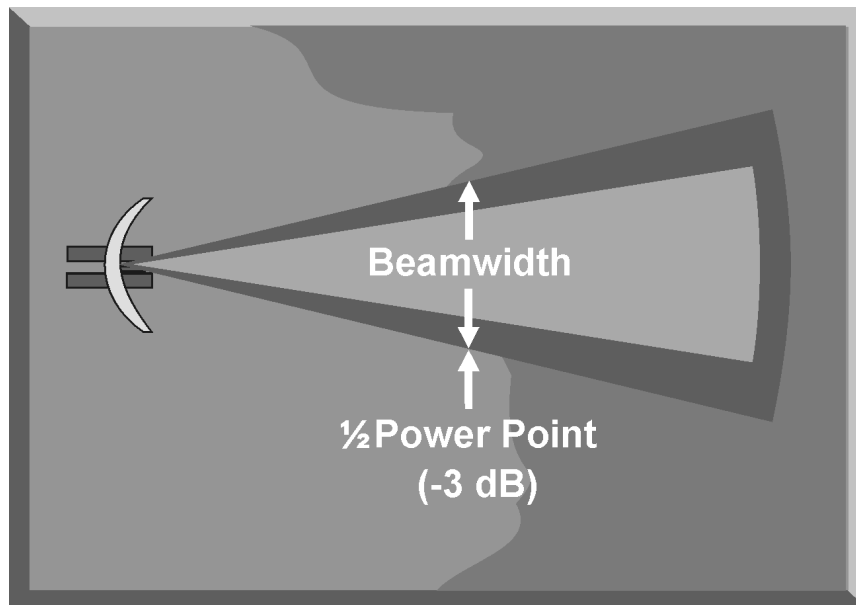

Figure 5-9. Radar Beamwidth

a. In order for a radar system to figure out target azimuth, the antenna must be aligned with a point of reference and pointed at the target during the transmission and reception of several pulses of radar energy. If the antenna is

referenced to true North, the azimuth of the target can be measured relative to true North (Figure 5-10). Azimuth determination is based on the position of the antenna when the target is being illuminated.

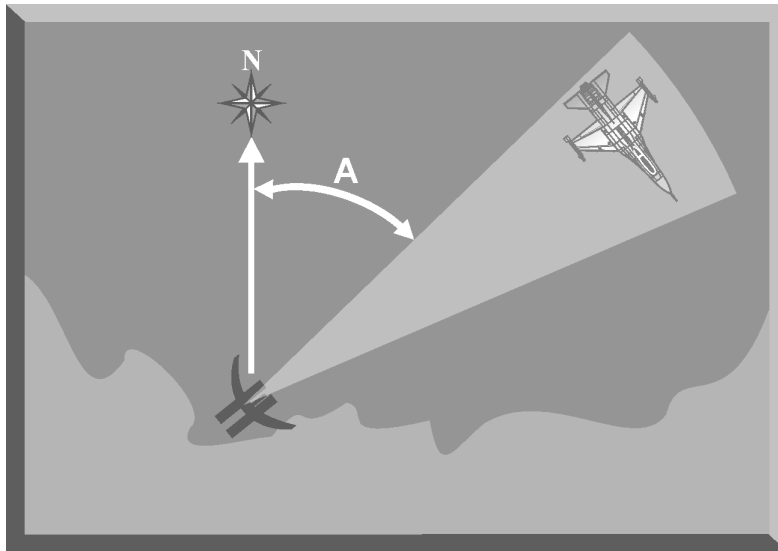

Figure 5-10. Azimuth Determination

(1) To provide accurate azimuth determination over a large area, many radars employ a narrow beam and scan the antenna in a predictable pattern. The most common scan pattern is a 360° circular scan at a constant rate (Figure 5-11). The plan position indicator (PPI) radar scope display is normally associated with this scan pattern. As the radar beam sweeps, a target is detected and displayed. The position of the antenna, when the target is displayed, shows the relative azimuth.

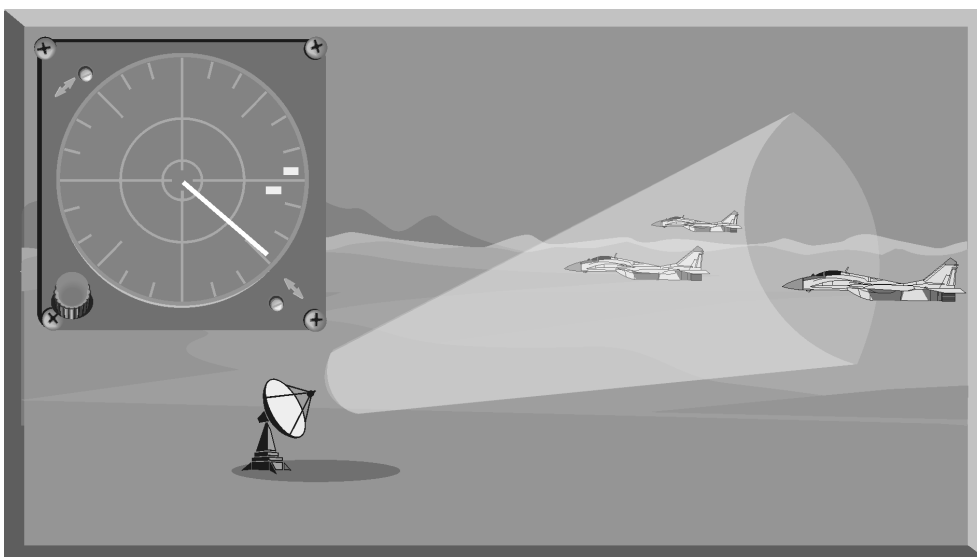

Figure 5-11. Antenna Scan

(2) The azimuth accuracy of a radar system is determined by the horizontal beamwidth (HBW). In Figure 5-12, radar system A has a horizontal beamwidth of 10° . As the beam sweeps, the target is illuminated for as long as it is in the beam. This means that the target covers 10° in azimuth on the PPI scope. Radar system B has a beamwidth of 1° . A target displayed on the PPI scope will cover 1° in azimuth. The narrower the horizontal beamwidth, the better the azimuth accuracy.

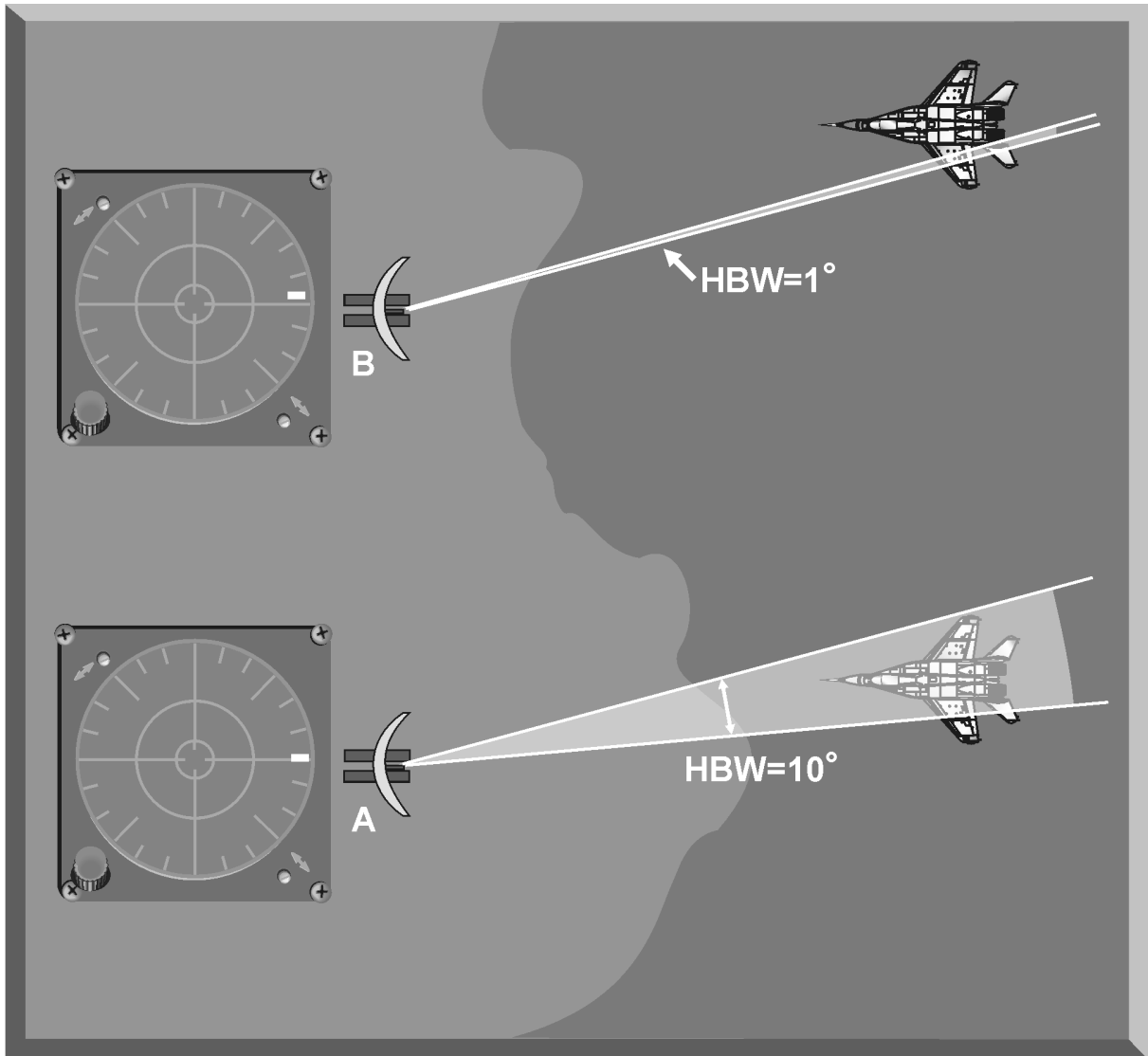

Figure 5-12. Horizontal Beamwidth Comparison

b. Azimuth resolution is the ability of a radar to display two targets flying at approximately the same range with little angular separation, such as two fighters flying line-abreast tactical formation. The azimuth resolution capability is usually expressed in nautical miles and corresponds to the minimum azimuth separation

required between two targets for separate display. Azimuth resolution depends on the horizontal beamwidth of the radar. The radar system in Figure 5-13 has a horizontal beamwidth of 10° . The two targets are so close in azimuth that the return echoes are blended into one return.

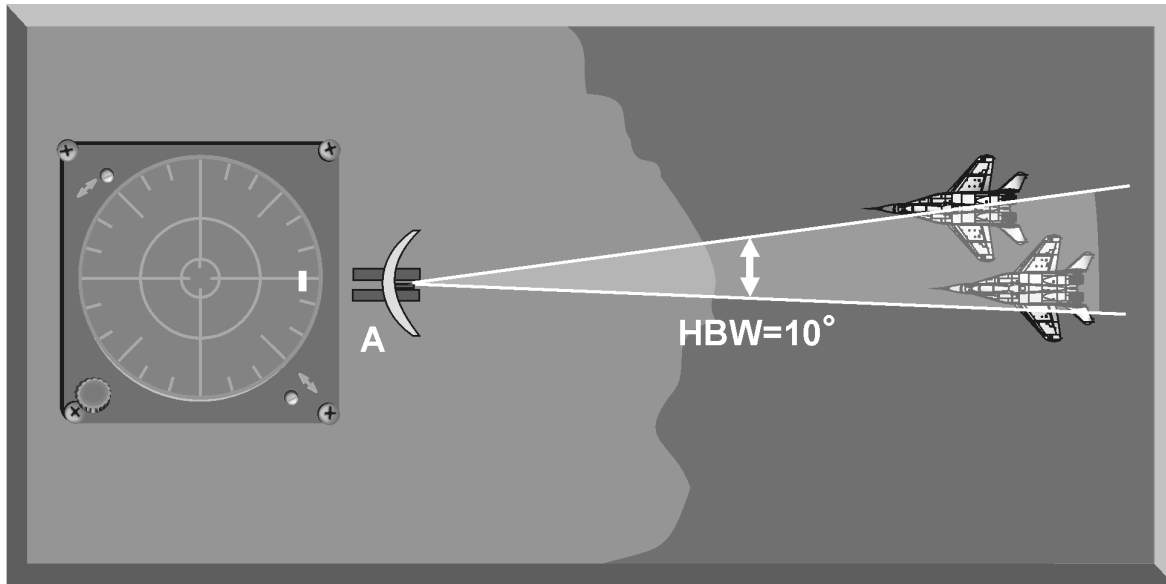

Figure 5-13. Horizontal Beamwidth and Azimuth Resolution

(1) The radar system in Figure 5-14 has a horizontal beamwidth of 1° . The radar beam not only hits the targets, but passes between them without causing a return. This allows the radars to display two distinct radar returns. A small horizontal beamwidth improves azimuth resolution.

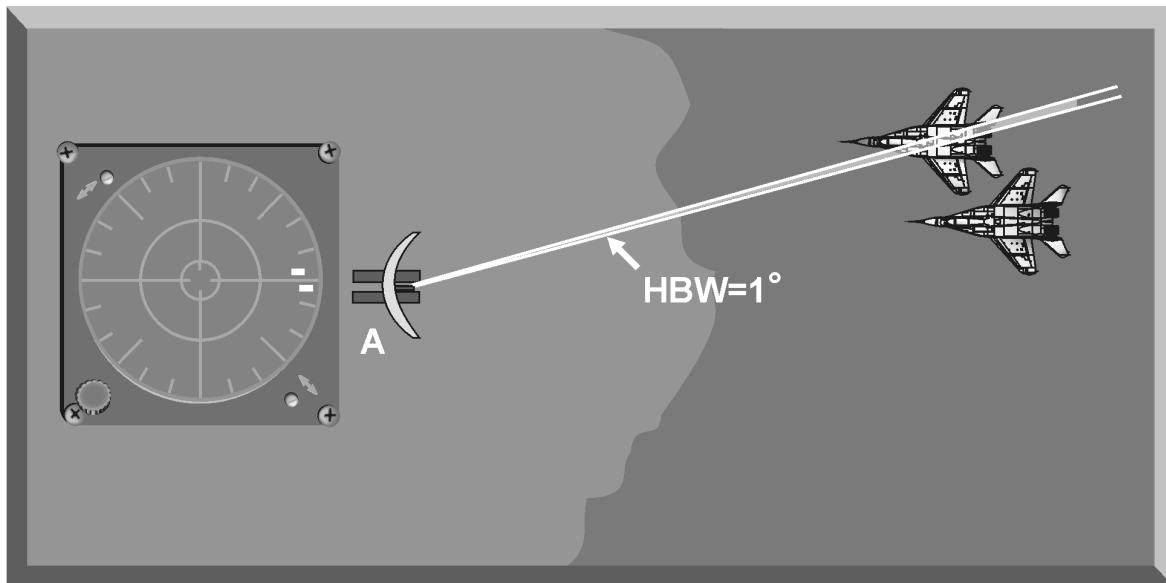

Figure 5-14. Azimuth Resolution

(2) Azimuth resolution, in nautical miles, can be computed using Equation 5-5. Notice that this equation is the “60 to 1 rule” used for navigation. A 1° beamwidth will yield a one-mile-wide cell at 60 nautical miles.

$$\text{Azimuth Resolution} = \frac{\text{Horizontal Beamwidth} \times \text{Range}}{60}$$

Equation 5-5. Azimuth Resolution

4. ELEVATION DETERMINATION

Since a radar beam is three-dimensional, the vertical beamwidth is the primary factor in determining altitude resolution capability. Altitude resolution is the ability of a radar to display two targets flying at approximately the same range and azimuth with little altitude separation, such as two fighters flying a vertical stack formation. The altitude resolution capability is usually expressed in feet and corresponds to the minimum altitude separation required between two targets for separate display. The radar system in Figure 5-15 has a vertical beamwidth of 10°. The two targets are so close in altitude that the return echoes depicted on the range height indicator (RHI) are blended into one.

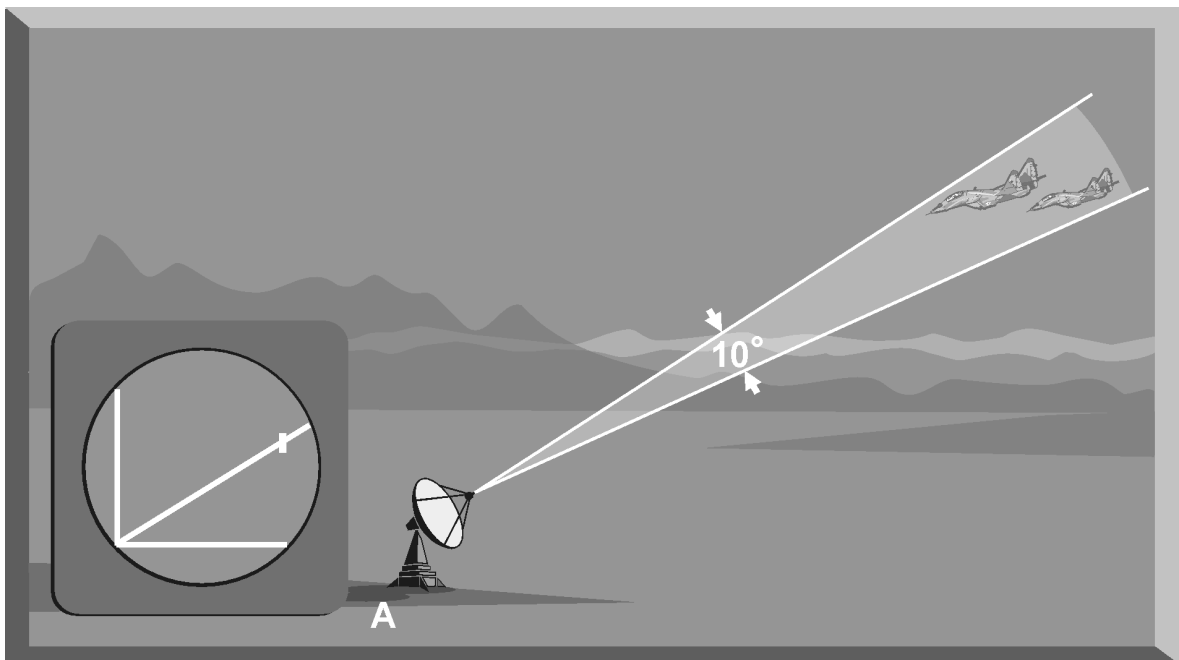

Figure 5-15. Vertical Beamwidth and Elevation Resolution

a. The radar system depicted in Figure 5-16 has a vertical beamwidth of 1°. This small beam not only hits the targets, but passes between them without causing a return. This allows the radar to display two distinct targets.

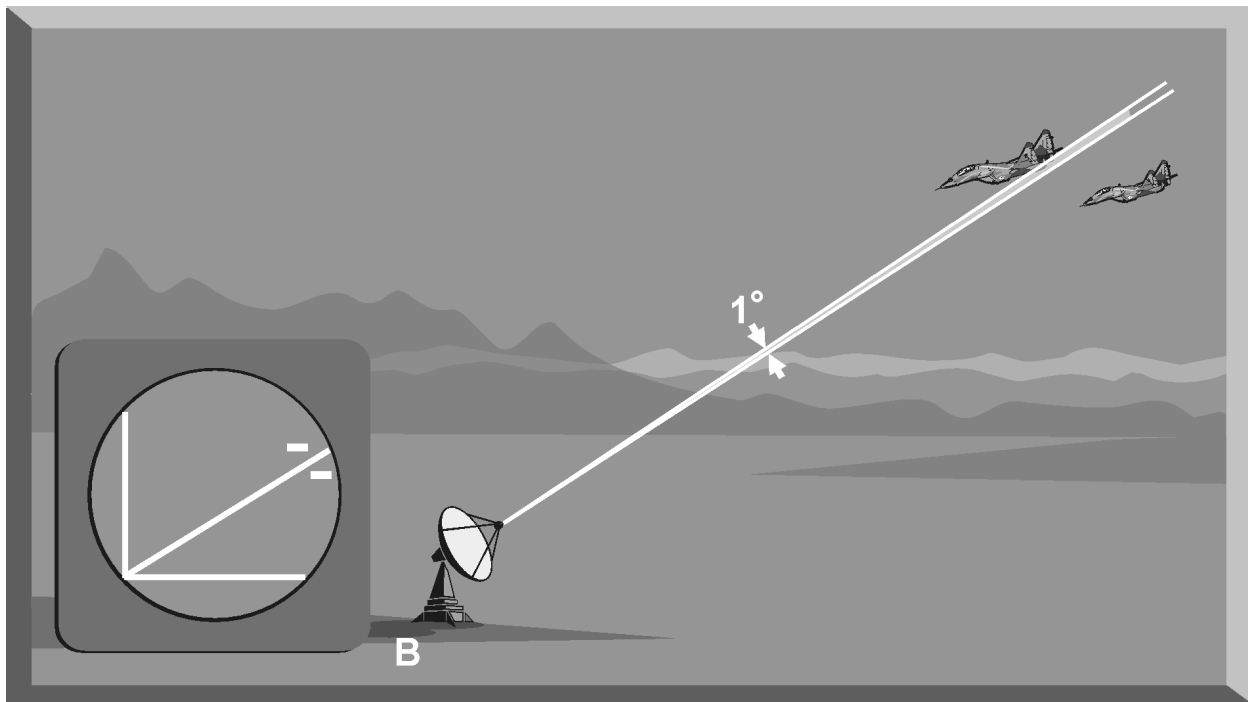

Figure 5-16. Elevation Resolution

b. Altitude/elevation resolution, in thousands of feet, can be computed using Equation 5-6.

$$\text{Altitude Resolution} = \frac{\text{Vertical Beamwidth} \times \text{Range}}{60}$$

Equation 5-6. Altitude Resolution

5. RADAR RESOLUTION CELL

A radar's pulse width, horizontal beamwidth, and vertical beamwidth form a three-dimensional resolution cell (RC) (Figure 5-17). A resolution cell is the smallest volume of airspace in which a radar cannot determine the presence of more than one target. The resolution cell of a radar is a measure of how well the radar can resolve targets in range, azimuth, and altitude. The horizontal and vertical

dimensions of a resolution cell vary with range. The closer to the radar, the smaller the resolution cell.

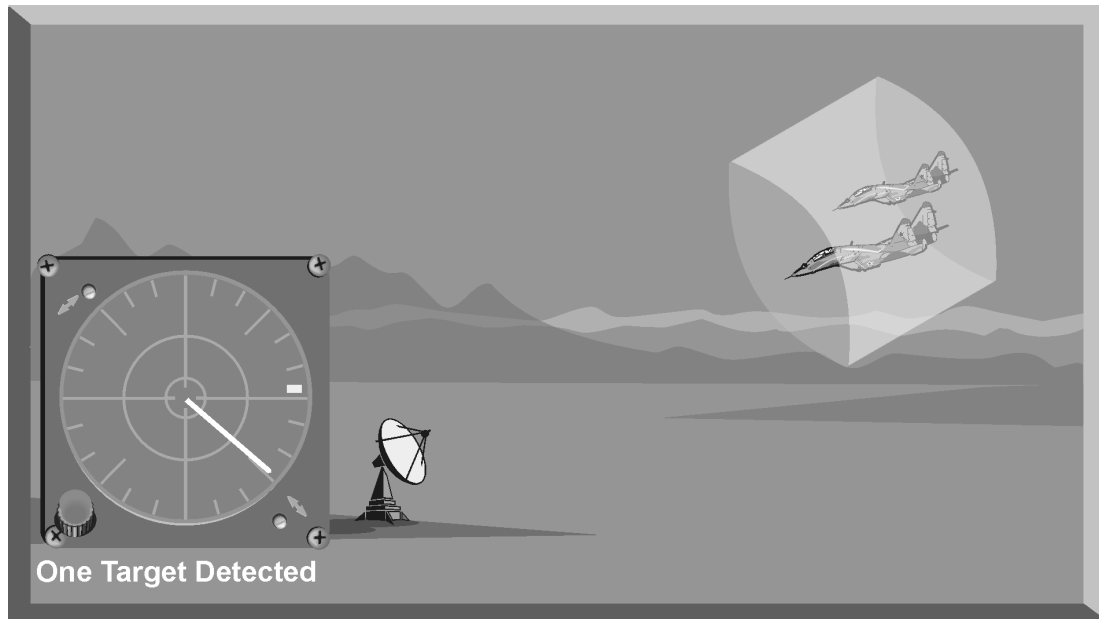

Figure 5-17. Radar Resolution Cell

a. The physical dimensions of a radar's resolution cell can be computed. For a radar with a pulse width of 1 microsecond, a horizontal beamwidth of 1°, and a vertical beamwidth of 10°, the formulas for range resolution, azimuth resolution, and altitude resolution can be used to compute the dimensions of the resolution cell. In the example in Figure 5-18, at a target range of 10 nm, the physical dimensions of the radar's resolution cell are 492 feet in range, by 1000 feet in azimuth, and 10,000 feet in altitude. These figures can be confirmed by using Equations 5-4, 5-5, and 5-6.

$$A = \text{Pulse Width} \times \frac{\text{Speed of Light}}{2}$$

$$A = 1 \text{ Microsecond} \times \frac{984 \text{ feet per microsecond}}{2}$$

$$A = 492 \text{ feet}$$

Figure 5-18. Radar Resolution Cell Dimensions

b. Based on these computations, two, or more, aircraft flying a trail formation closer than 492 feet would be displayed as a single target. Two, or more, aircraft flying line abreast closer than 1000 feet would be displayed as a single target. Two, or more, aircraft flying a vertical stack closer than 10,000 feet would be displayed as a single target. This also shows that the shorter the pulse width, the better the range resolution capability of a radar system. The narrower the horizontal beamwidth, the better the azimuth resolution capability. The narrower the vertical beamwidth, the better the altitude resolution capability.

c. Another type of resolution is velocity resolution. For a Doppler radar aircraft flying within the conventional resolution cell described above can be distinguished as separate targets if they have enough speed differential. Paragraph 6 below will describe how this is carried out.

6. PULSE DOPPLER VELOCITY DETERMINATION

To fully understand how a pulse Doppler radar determines target velocity, it is necessary to know more about the pulsed waveform. To generate a pulse modulated wave, a continuous carrier sine wave, like the output from a CW radar, is combined with a rectangular wave, like that of a pulse radar, to produce the pulse modulated waveform. Figure 5-19 depicts pulse modulation.

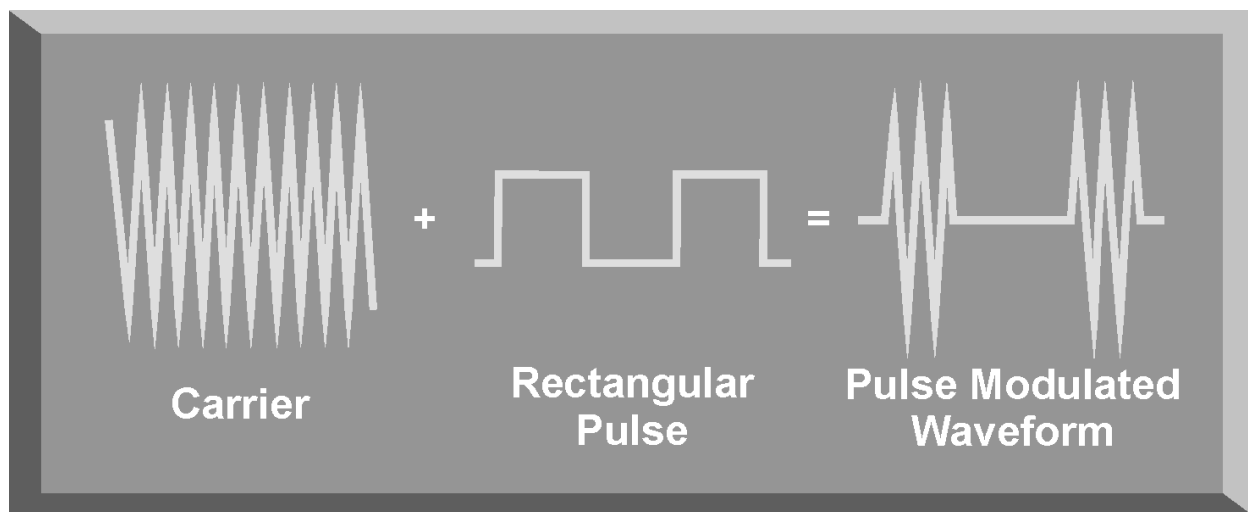

Figure 5-19. Pulse Modulation

a. Mathematically, any waveform other than a sine wave is composed of many different pure sine waves added in the proper amplitude and phase relationships (Figure 5-20). In a pulsed modulated waveform, the sine waves correspond to the fundamental frequency, which is the PRF, and the sum of all harmonics in the proper amplitude and phase. The frequency of the harmonic is the basic frequency plus or minus a multiple of the PRF.

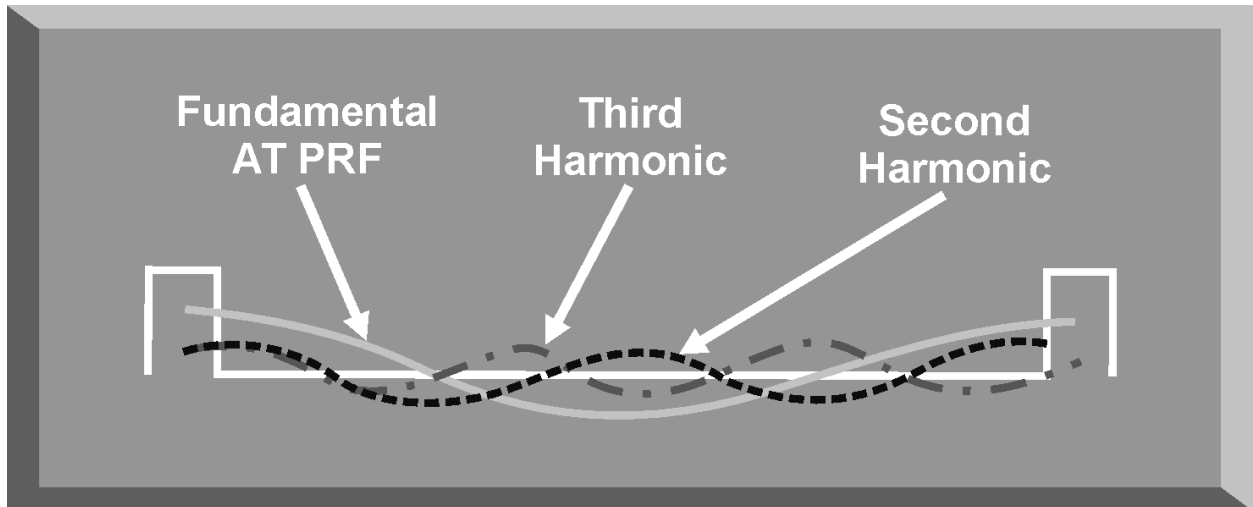

Figure 5-20. Harmonics of a Pulse Modulated Waveform

(1) Figure 5-21 is a plot of the harmonic content of a pulse modulated waveform operating at a carrier frequency of 2800 megahertz (MHz) with a PRF of 1 MHz. Note the loops of frequencies on either side of the carrier frequency. These are the additions and subtractions of all the frequencies in the rectangular pulse to the carrier frequency. The important thing to remember is that there are many frequencies present, and a pulse Doppler radar must deal with a crowded frequency spectrum. This becomes even more important when one considers the fact that every frequency present will experience a Doppler shift when it is reflected by a moving target. The individual frequencies shown are called spectral lines.

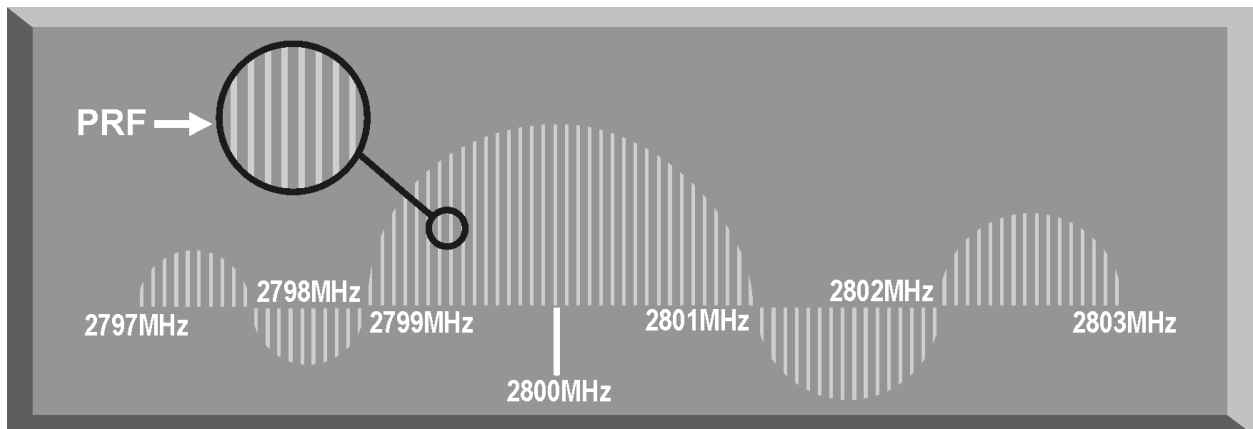

Figure 5-21. Harmonic Content

(2) For a pulse Doppler radar to accurately measure velocity, it must compare the frequency change, or Doppler shift, between the carrier frequency

and the frequency returning from the target. It is a difficult task for the radar to differentiate between the returning carrier and all the harmonic frequencies (Figure 5-22).

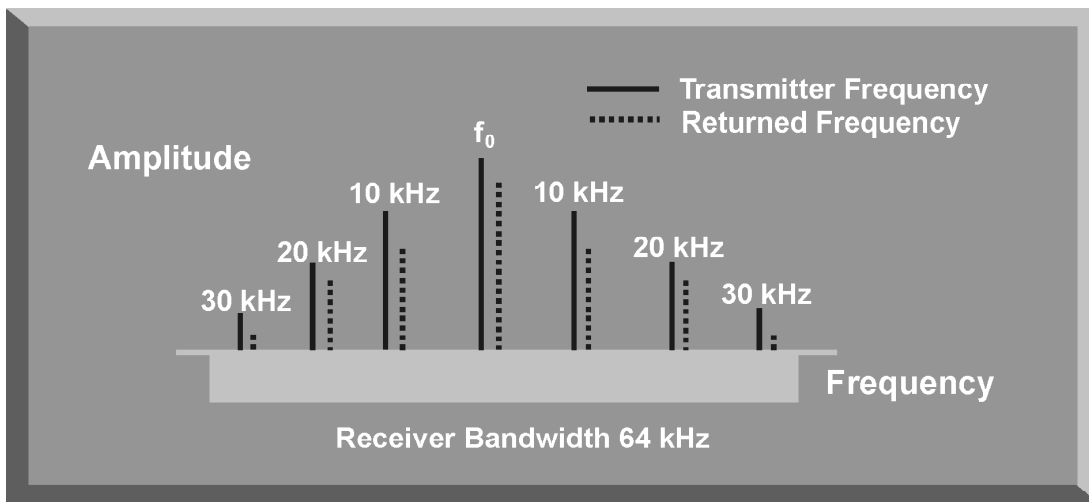

Figure 5-22. Spectral Line Frequencies

b. The radar differentiates between the returning carrier frequencies and all other harmonic frequencies by using clutter cancellers, or filters, at the known harmonic frequencies (Figure 5-23). The radar cannot process frequencies cancelled by these filters. The filters create “blind speeds” for the radar. The closer together the spectral lines, the more “blind speeds” the radar will have.

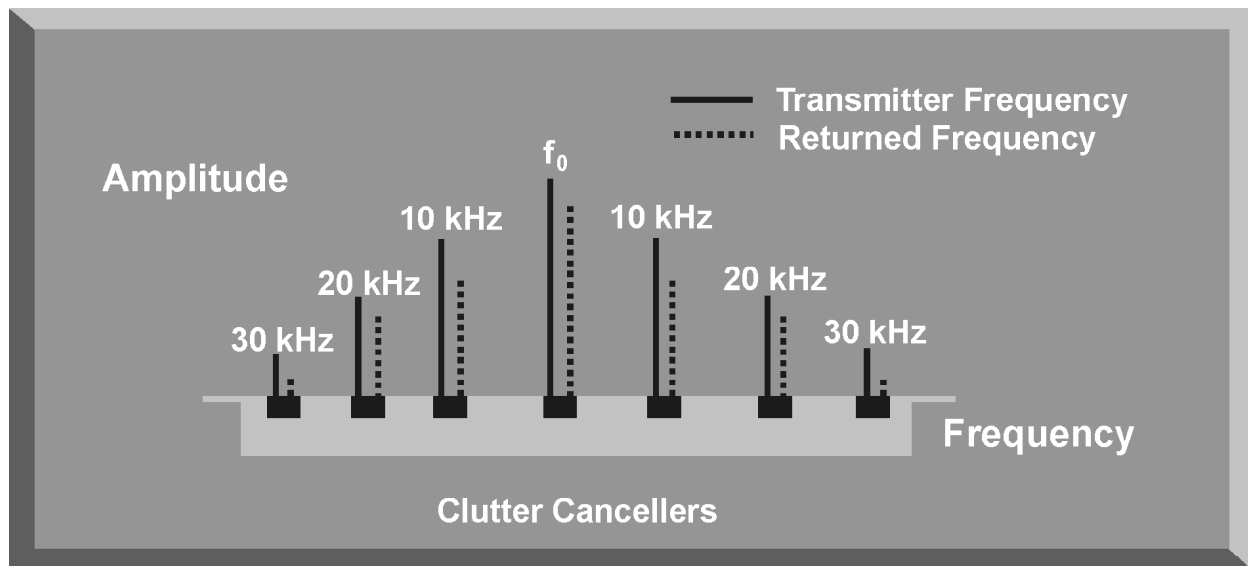

Figure 5-23. Selective Clutter Canceling

(1) Since the position of the harmonics in relation to the carrier frequency is based on PRF, the number of blind speeds can be reduced by changing the PRF of the radar. The higher the PRF, the wider the spacing of the spectral lines and the fewer blind speeds due to selective clutter canceling. However, a high PRF increases the problem of range ambiguities. Most modern pulse Doppler radars employ a medium and high PRF mode. Medium PRF equates to fewer range ambiguities but more blind speeds. High PRF has fewer blind speeds but more range ambiguities (Figure 5-24).

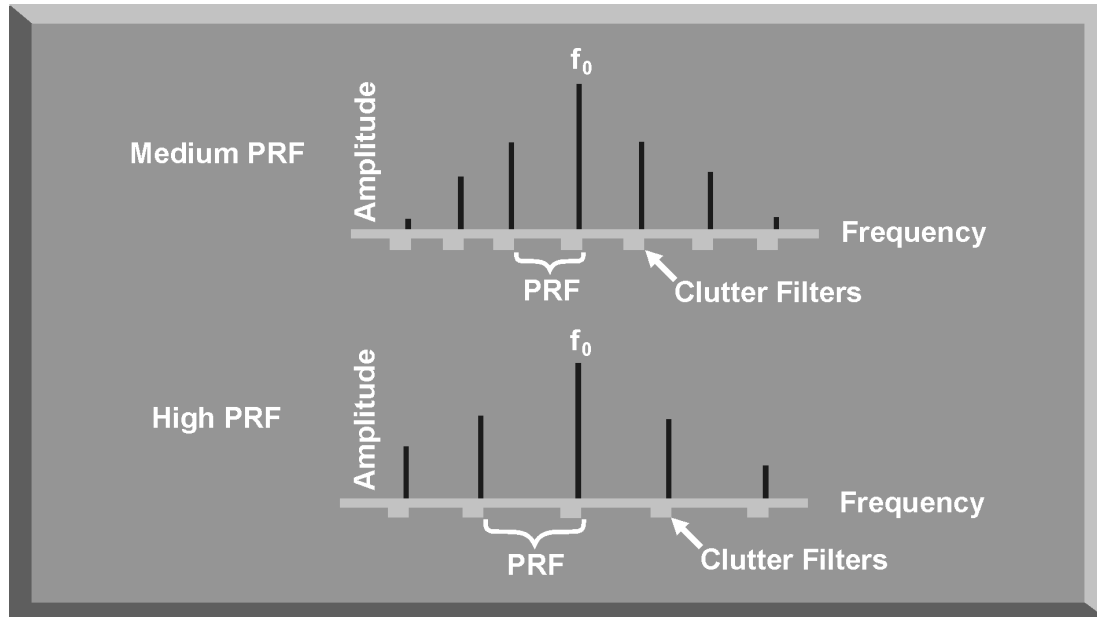

Figure 5-24. PRF and Spectral Lines

(2) To separate the returning target frequency shifts from all other frequencies in the returning waveform, the pulse Doppler radar employs filters to cancel the known harmonic frequency shifts. In addition, the radar cancels out all returns with no frequency shift, which equates to canceling all returns with no movement relative to the radar. However, if the radar has too many clutter filters, this creates multiple blind speeds, and targets will be missed. In Figure 5-25, the detection filters allow target frequencies to be processed, and clutter filters cancel unwanted frequency shifts. Target 1 will be detected, but Target 2 will be canceled.

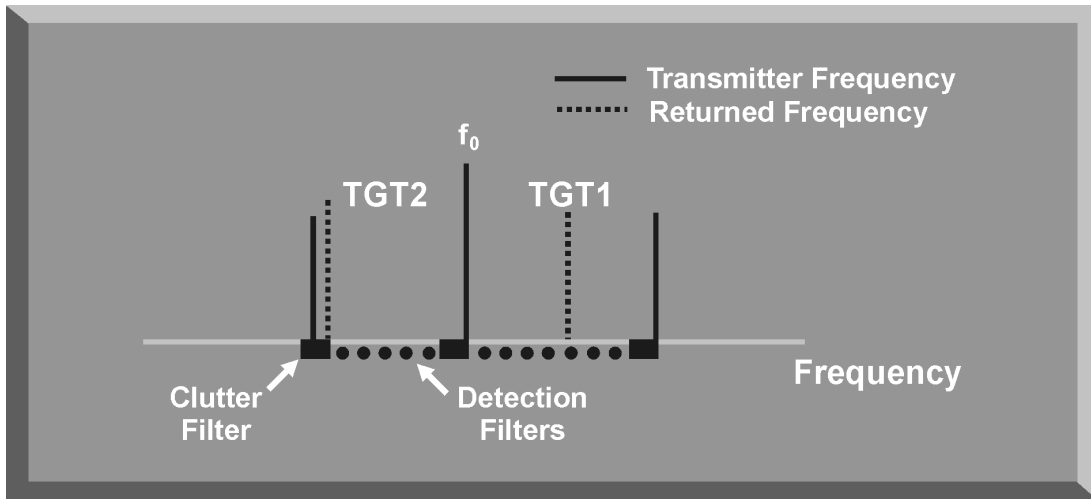

Figure 5-25. Pulse Doppler Filters

7. BASIC RADAR EQUATION

The basic radar equation relates the range of a radar system to the characteristics of the transmitter, receiver, antenna, and the target. The radar equation provides a means not only to figure out the maximum range of a particular radar system, but it can be used to understand the factors that affect radar operation. In this section, the simple forms of the radar equation are developed, starting with the power density of the transmitting antenna to the power received by the receiving antenna.

a. Power density is the power of a radio wave per unit of area normal to the direction of propagation. The power density generated by a practical antenna can be expressed in Equation 5-7.

$$\text{Power Density from Antenna} = \frac{P_T \times G}{4\pi r^2}$$

P_T = transmitted power
 G = antenna gain
 r = radius of the antenna

Equation 5-7. Power Density From an Antenna

b. As the radar beam propagates through space, it arrives at a target at some range (R) from the antenna. As the radar beam travels through space, the wavefront of the beam expands to a very large cross-sectional area, especially in relation to the target dimensions. The power density of the radar beam, across this wide area, at the target, is detailed in Equation 5-8.

$$\text{Power Density at Target} = \frac{P_T \times G}{4\pi R^2}$$

P_T = transmitted power
 G = antenna gain
 R = range to the target

Equation 5-8. Power Density at the Target

c. Since the cross-sectional area of the radar beam is so large, only a small portion of the total power in the beam can be reflected toward the antenna. The rest of the radar energy continues through space and is dissipated, absorbed, or reflected by other targets. The small portion of the radar beam that hits the target is reradiated in various directions. The measure of the amount of incident power intercepted by the target and reradiated back in the direction of the antenna depends on the radar cross section (RCS) of the target. Equation 5-9 details the power density of the target echo signal reflected back to the radar antenna.

$$\text{Power Density at Antenna} = \frac{P_T \times G}{4\pi R^2} \times \frac{\sigma}{4\pi R^2}$$

P_T = transmitted power
 G = antenna gain
 σ = RCS
 R = range to the target

Equation 5-9. Power Density at the Antenna

d. As the target echo reaches the antenna, part of the echo is captured by the antenna based on the effective aperture (A_e). Equation 5-10 details the actual signal power received by the radar system. This is one form of the basic radar equation and is the signal strength of a radar return from a specific target at range (R) from the radar.

$$\text{Signal Power Density (S)} = \frac{P_T G \sigma A_e}{(4\pi)^2 R^4}$$

P_T = transmitted power
 G = antenna gain
 σ = RCS
 R = range to the target
 A_e = antenna aperture area

Equation 5-10. Signal Power Density

e. A detailed analysis of this equation is not required to draw some basic conclusions about the factors affecting the detection of an aircraft. If any factor in the numerator, such as transmitted power, is increased by a factor of three, the signal received by the radar will increase by only 30 percent. This clearly shows why radar system operation is characterized by the transmission of megawatts of power and the reception of microwatts of returning power. In addition, this equation shows that the most critical factor in determining radar detection is target range.

f. The maximum radar range (R_{MAX}) occurs when the signal power density received just equals the minimum detectable signal (S_{MIN}) for the receiver. Solving Equation 5-11 for range, and substituting S_{MIN} , yields the basic radar equation for R_{MAX} for a specific target. This is another form of the basic radar equation.

$$R_{MAX} = \frac{[P_T G \sigma A_e]^{1/4}}{[(4\pi)^2 S_{MIN}]}$$

P_T = transmitted power
 G = antenna gain
 σ = RCS
 A_e = antenna aperture area
 R = range to the target

Equation 5-11. Basic Radar Equation

g. It is important to note that the basic radar equations do not consider such factors as meteorological conditions, changes in aircraft RCS, the impact of clutter on gain, or operator abilities. The radar equation does explain why a radar system designed for long-range detection should transmit a very high power signal, concentrated into a narrow beam, collected by a large antenna, and processed by a very sensitive receiver.

8. SUMMARY

This chapter has discussed the methods employed by radar systems to determine target range, azimuth, elevation, and velocity. The relationship between pulse width and range resolution, beamwidth and azimuth/elevation resolution, and PRF and velocity resolution have been explained. In addition, an explanation of the complex radar equation has been presented. The capabilities and limitations of a specific radar system to determine these critical target parameters is the key to understanding the countermeasures designed to defeat this system.

CHAPTER 6. ANTENNA CHARACTERISTICS AND SCANS

1. INTRODUCTION

The function of the antenna during transmission is to concentrate the radar energy from the transmitter into a shaped beam that points in the desired direction. During reception, or listening time, the function of the antenna is to collect the returning radar energy, contained in the echo signals, and deliver these signals to the receiver. Radar antennas are characterized by directive beams that are usually scanned in a recognizable pattern. The primary antenna types in use today fall into three categories: parabolic, Cassegrain, or phased array antennas. Additionally, the method radar antennas employ to sample the environment is a critical design feature of the radar system. The scan type selected for a particular radar system often decides the employment of that radar in an integrated air defense system (IADS). The process the radar antenna uses to search airspace for targets is called scanning or sweeping. This chapter discusses circular, unidirectional, bidirectional, helical, raster, Palmer, and conical scans, and track-while-scan (TWS) radar systems.

2. PARABOLIC ANTENNA

One of the most widely used radar antennas is the parabolic reflector (Figure 6-1). The parabola-shaped antenna is illuminated by a source of radar energy, from the

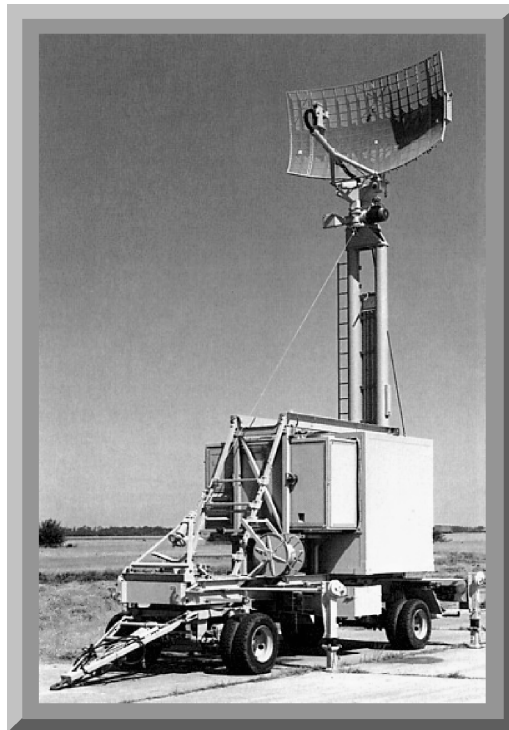

Figure 6-1. Parabolic Antenna

transmitter, called the feed. The feed is placed at the focus of the parabola, and the radar energy is directed at the reflector surface. Because a point source of energy, located at the focus, is converted into a wavefront of uniform phase, the parabola is well suited for radar antenna applications. By changing the size and shape of the parabolic reflecting surface, a variety of radar beam shapes can be transmitted.

a. The antenna depicted in Figure 6-1 generates a nearly symmetrical pencil beam that can be used for target tracking.

b. Elongating the horizontal dimensions of the parabolic antenna creates a radar antenna called the parabolic cylinder antenna (Figure 6-2). The pattern of this antenna is a vertical fan-shaped beam. Combining this antenna pattern with a circular scan technique creates a radar system well suited for long-range search and target acquisition.



Figure 6-2. Parabolic Cylinder Antenna

c. Elongating the vertical dimensions of the parabola creates a radar antenna that generates a horizontal fan-shaped beam with a small vertical dimension (Figure 6-3). This type of antenna is generally used in height-finding radar systems.



Figure 6-3. Height-Finder Parabolic Antenna

d. Another variation of the basic parabolic antenna includes using an array of multiple feeds instead of a single feed (Figure 6-4). This type of parabolic antenna can produce multiple radar beams, either symmetrical or asymmetrical, depending on the angle and spacing of the individual feeds.



Figure 6-4. Multiple-Feed Parabolic Antenna

3. CASSEGRAIN ANTENNA

A Cassegrain antenna uses a two-reflector system to generate and focus a radar beam (Figure 6-5). The primary reflector uses a parabolic contour, and the secondary reflector, or subreflector, has a hyperbolic contour. The antenna feed

is located at one of the two foci of the hyperbola. Radar energy from the transmitter is reflected from the subreflector to the primary reflector to focus the radar beam. Radar energy returning from a target is collected by the primary reflector and reflected as a convergent beam to the subreflector. The radar energy is rereflected by the subreflector, converging at the position of the antenna feed. The larger the subreflector, the closer it can be to the primary reflector. This reduces the axial dimensions of the radar but increases aperture blockage due to the subreflector. A small subreflector reduces aperture blockage, but it must be positioned at a greater distance from the primary reflector.

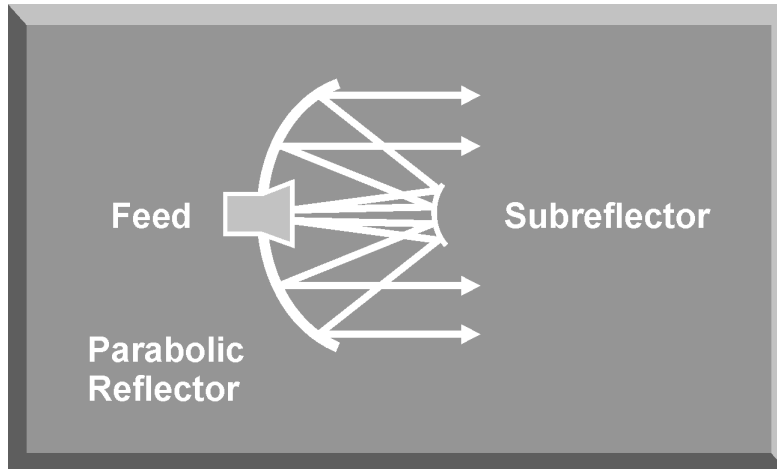

Figure 6-5. Cassegrain Antenna

a. To reduce the aperture blockage by the subreflector and to provide a method to rapidly scan the radar beam, the flat plate Cassegrain antenna was developed. This type of Cassegrain antenna is depicted in Figure 6-6.

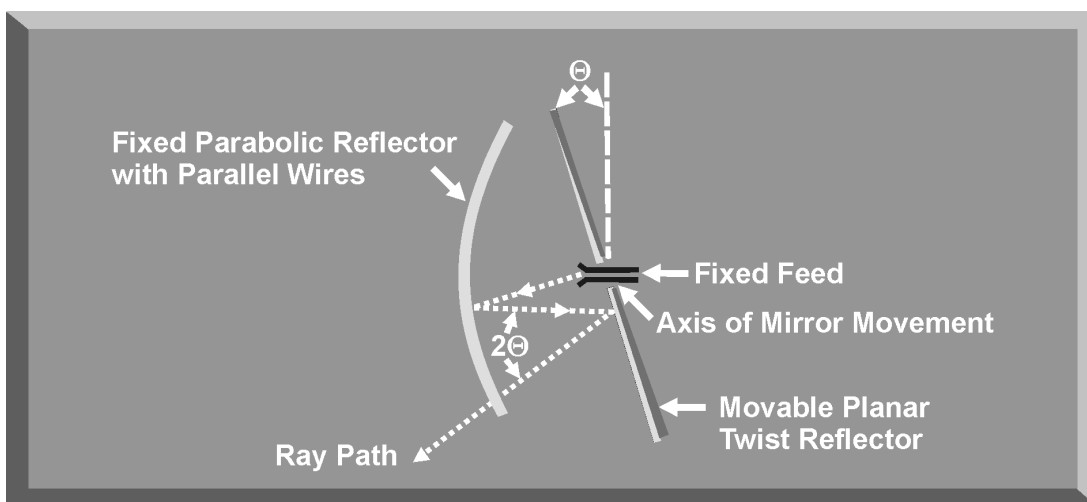

Figure 6-6. Flat Plate Cassegrain Antenna

The fixed parabolic reflector is made up of parallel wires spaced less than a half wavelength apart and supported by a low-loss dielectric material. This makes the fixed parabolic reflector polarization sensitive. It will completely reflect one type of linear polarization and be transparent to the orthogonal polarization. The fixed antenna feed, in the middle of the moveable mirror, transmits a radar signal polarized to be reflected by the parabolic reflector. The moveable mirror is constructed as a twist reflector that changes the polarization of the radar signal by 90° . The signal from the feed is reflected by the parabolic reflector to the mirror, which rotates the polarization 90° . This rotation makes the transmitted signal transparent to the parabolic reflector, and the signal passes through with minimal attenuation. The radar beam can be scanned over a wide area by rotating the moveable mirror. A deflection of the mirror by the angle θ results in the beam scanning through an angle of 2θ .

b. The geometry of the Cassegrain antenna is especially well suited for monopulse tracking radar applications. Unlike the parabolic antenna, the complex feed assembly required for a monopulse radar can be placed behind the reflector to avoid aperture blocking.

4. PHASED ARRAY ANTENNA

The phased array radar is a product of the application of computer and digital technologies to the field of radar design. A phased array antenna is a complex arrangement of many individual transmitting and receiving elements in a particular pattern. A phased array antenna can, in effect, radiate more than one beam from the antenna by using a computer to rapidly and independently control groups of these individual elements. Multiple beams and computer processing of radar returns give the phased array radar the ability to track-while-scanning and engage multiple targets simultaneously. Figure 6-7 is a view of the phased array radar antenna.

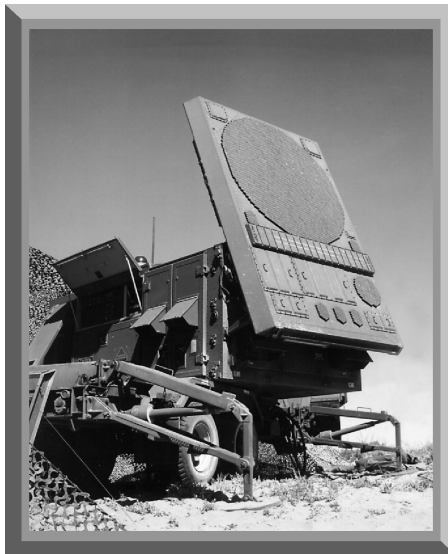

Figure 6-7. Phased Array Antenna

a. A phased array radar uses the principle of radar phase to control the individual transmitting and receiving elements. When two transmitted frequencies are in-phase, their amplitudes add together, and the radiated energy is doubled. When two transmitted frequencies are out-of-phase, they cancel each other. Phased array radars use this principle to control the shape of the transmitted radar beam (Figure 6-8).

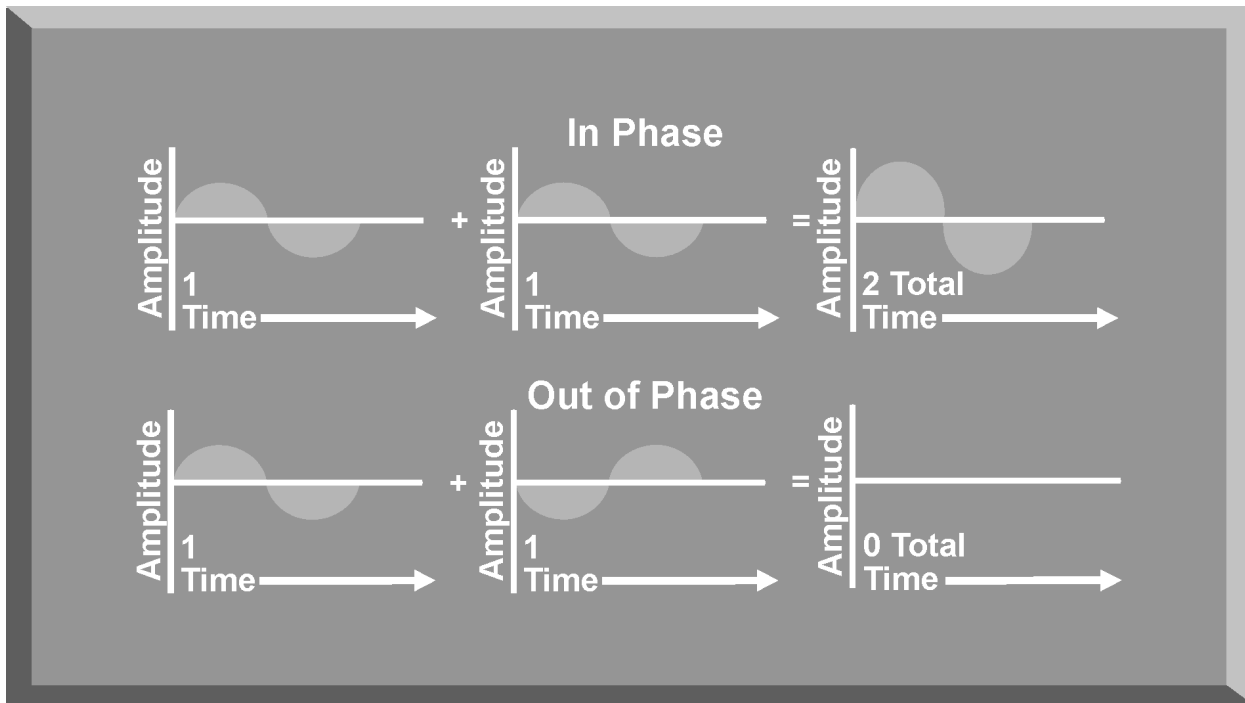

Figure 6-8. Phase Relationships

b. Phase relationships and antenna element spacing determine the orientation of the transmitted beam. In Figure 6-9, antenna elements A and B are separated by one-half wavelength and are radiating in-phase, that is, when one is at the positive peak, the other is also at a positive peak. Since the elements are one-half wavelength apart, when the positive peak radiated by A reaches B, B will be radiating a negative peak. As the peaks propagate along the X axis, they will cancel each other out. The total radiated power along that axis will be zero. Along the Y axis, however, the positive peaks from A will add to the positive peaks from B, causing the total radiation along this axis to be at its maximum value. This type of array is called a “broadside array” because most of the radiation is in the direction that is broadside to the line of the antenna array.

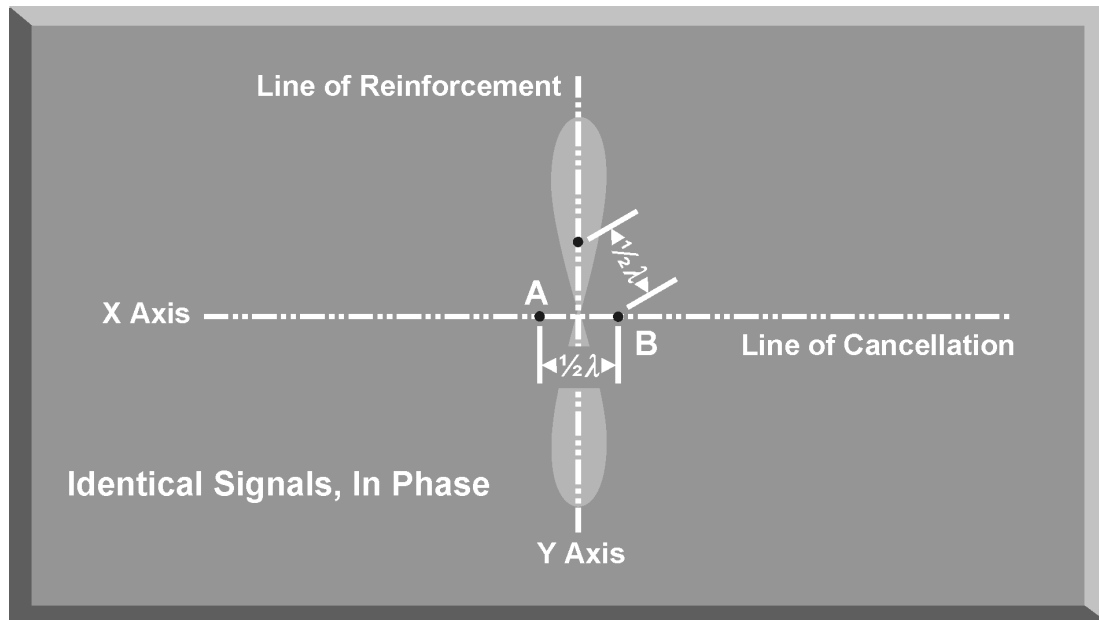

Figure 6-9. Broadside Array

c. If the same antenna elements are fed out-of-phase, the principal direction of radiation will be along the axis of the antenna elements. In Figure 6-10, when the positive peak from A arrives at B, B is now positive also. These energies interact to strengthen the energy being radiated from the ends of the array. Meanwhile, when the positive peak from A, radiating along the Y axis, meets the negative peak from B, they are canceled. This type of array is called an “end-fire array.”

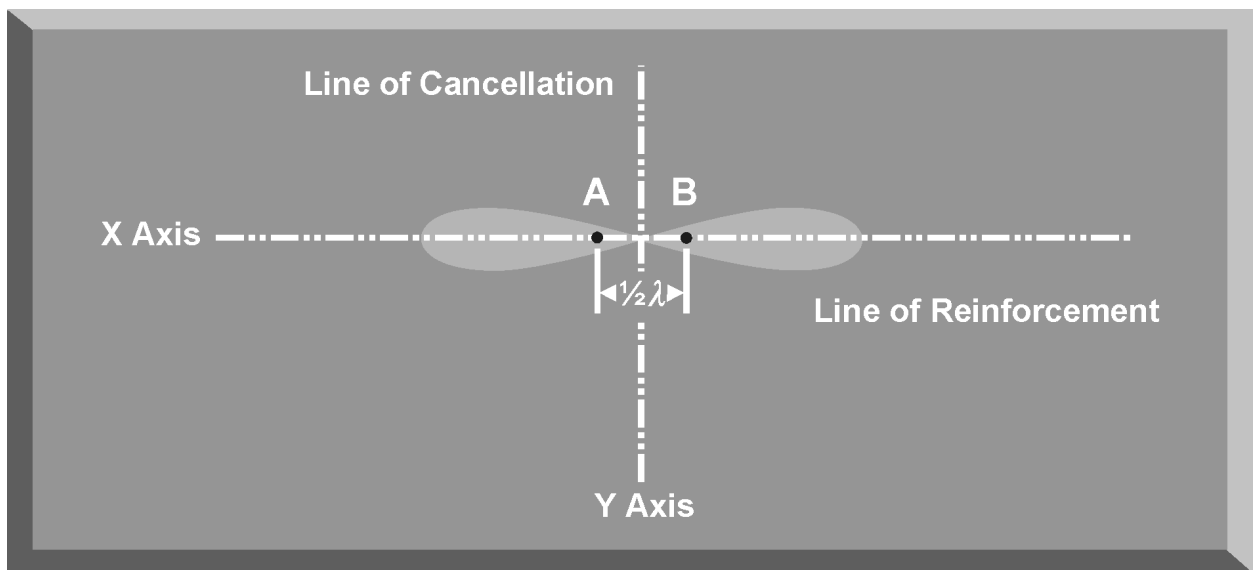

Figure 6-10. End-Fire Array

d. The computer controlling the phase of the signal delivered to each transmitting and receiving element of a phased array antenna controls the direction and shape of the radiated beam (Figure 6-11). By shifting the phase of the signals between 0° and 180° , the beam sweeps. This is the basic means of producing an antenna scan. In addition, the amplitude, or power, of the signal applied to each element can be varied to control the sidelobes. This alters the shape of the beam which affects the range capability and angular resolution of the radar.

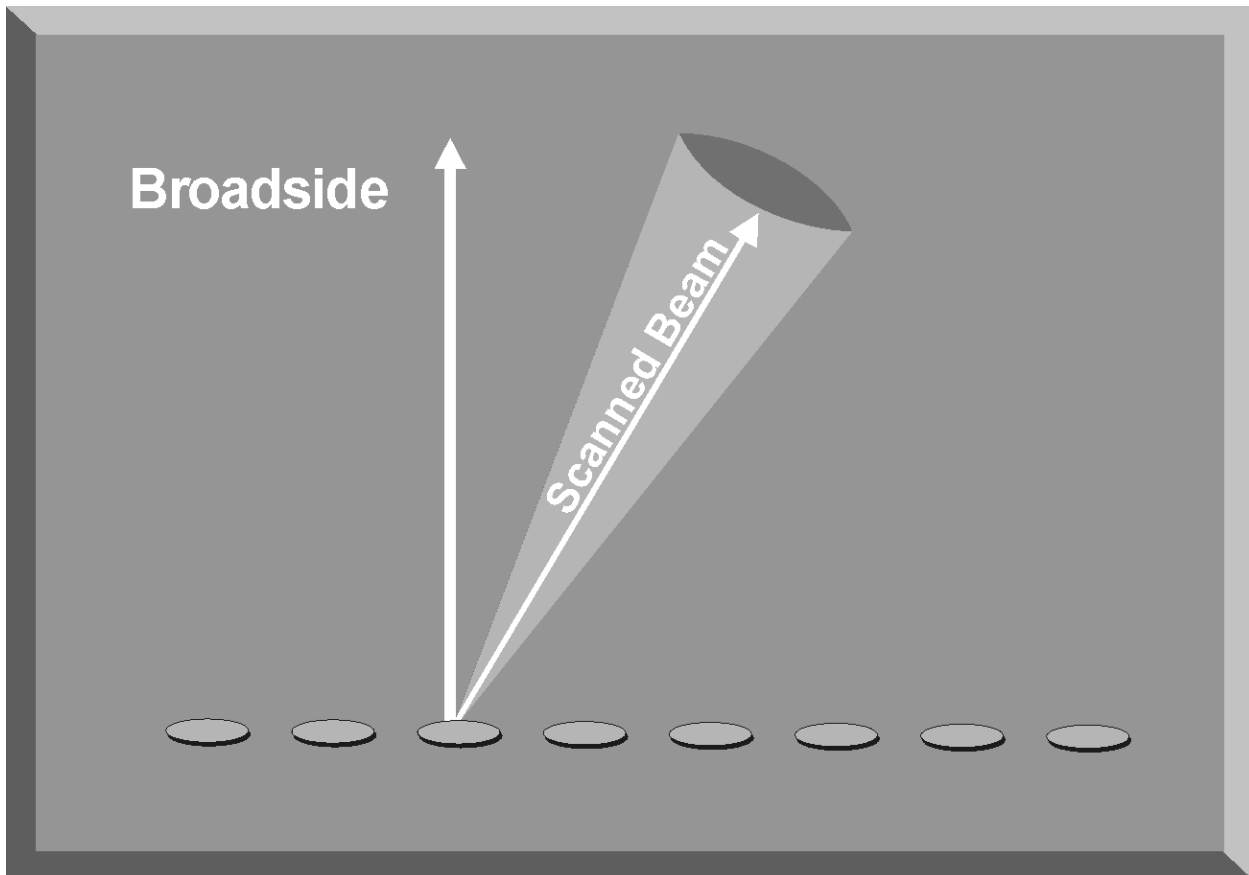

Figure 6-11. Phased Array Antenna Scan

e. Figure 6-12 depicts a variation of the phased array antenna, known as a planar array antenna. A planar array antenna uses transmit and receive elements in a linear array, but, unlike the phased array radar, the elements are smaller and are placed on a movable flat plate. The ability to simultaneously track several targets is one advantage of this type of radar.

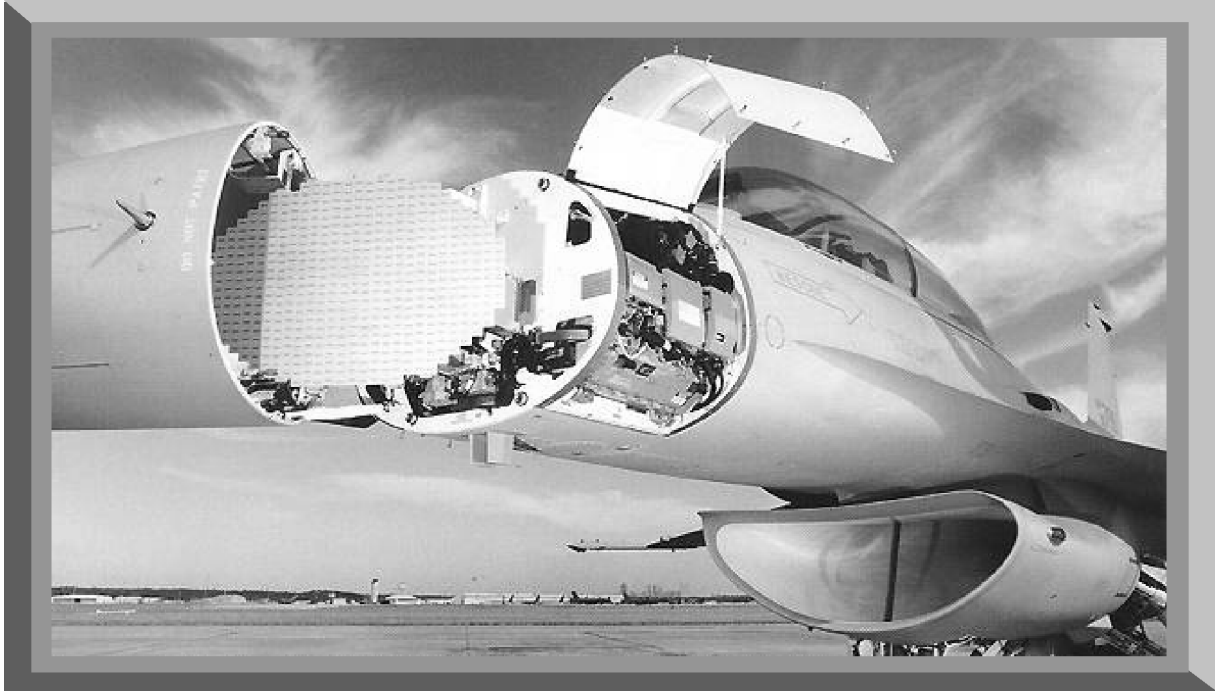

Figure 6-12. Planar Array Antenna

5. ANTENNA GAIN

The most important characteristic of any type of antenna is antenna gain. Antenna gain is a measure of the ability of an antenna to concentrate energy in the desired direction. Antenna gain should not be confused with receiver gain, which is designed to control the sensitivity of the receiver section of a radar system. There are two types of antenna gain: directive and power.

a. The directive gain of a transmitting antenna is the measure of signal intensity radiated in a particular direction. Directive gain is dependent on the shape of the radiation pattern of a specific radar antenna. The directive gain does not take into account the dissipative losses of the antenna. Directive gain is computed using Equation 6-1.

$$G_D \text{ (Directive Gain)} = \frac{\text{Maximum Radiation Intensity (Desired Direction)}}{\text{Average Radiation Intensity}}$$

Equation 6-1. Directive Gain

b. The power gain does include the antenna dissipative losses and is computed using Equation 6-2.

$$G \text{ (Power Gain)} = \frac{\text{Maximum Radiation Intensity (Practical Antenna)}}{\text{Radiation Intensity of an Isotropic Antenna}}$$

Equation 6-2. Power Gain

c. The term isotropic antenna describes a theoretical spherical antenna that radiates with equal intensity in all directions. This results in a spherical radiation pattern. The power density for any point on an isotropic antenna is the radiation intensity and can be calculated by dividing the total power transmitted (P_T) by the total surface area of the sphere, as shown in Equation 6-3.

$$\text{Power Density (Isotropic Antenna)} = \frac{P_T \text{ (Watts)}}{4\pi r^2 \text{ (Centimeters}^2\text{)}}$$

Equation 6-3. Power Density for an Isotropic Antenna

d. The radiation pattern of an isotropic, or spherical, antenna would provide neither azimuth or elevation resolution and would be unusable for radar applications. To provide azimuth and elevation resolution, a practical antenna must focus the radar energy. The power density of a practical antenna differs from the isotropic antenna only in terms of antenna gain (G). Solving Equation 6-3 for the power density of a practical antenna yields Equation 6-4.

$$\text{Power Density (Practical Antenna)} = \frac{P_T G}{4\pi r^2}$$

Equation 6-4. Power Density for a Practical Antenna

e. The actual power gain (G) of a practical antenna can be calculated by using Equation 6-5.

$$G = \frac{4\pi A_e}{\lambda^2} \quad \begin{array}{l} A_e = \text{effective area of aperture} \\ \lambda = \text{wavelength of the radar} \end{array}$$

NOTE: The effective area of aperture (A_e) is the effective antenna area presented to the returning radar echo.

Equation 6-5. Power Gain of a Practical Antenna

6. POWER DENSITY

The power density and gain of an antenna are a function of the antenna pattern of a radar system. Figures 6-13 and 6-14 illustrate the antenna pattern of a typical parabolic antenna. Most of the power density of the radar is concentrated in the main beam. However, since the radar is not a perfect reflector, some radar energy is transmitted in the sidelobes. In addition, there is spillover radiation due to the energy radiated by the feed that is not intercepted by the reflector. Finally, the radar has a back lobe caused by diffraction effects of the reflector and direct signal leakage. Sidelobes and backlobes are all undesirable radiations that adversely affect the maximum radar range and increases the vulnerability of the radar to certain jamming techniques.

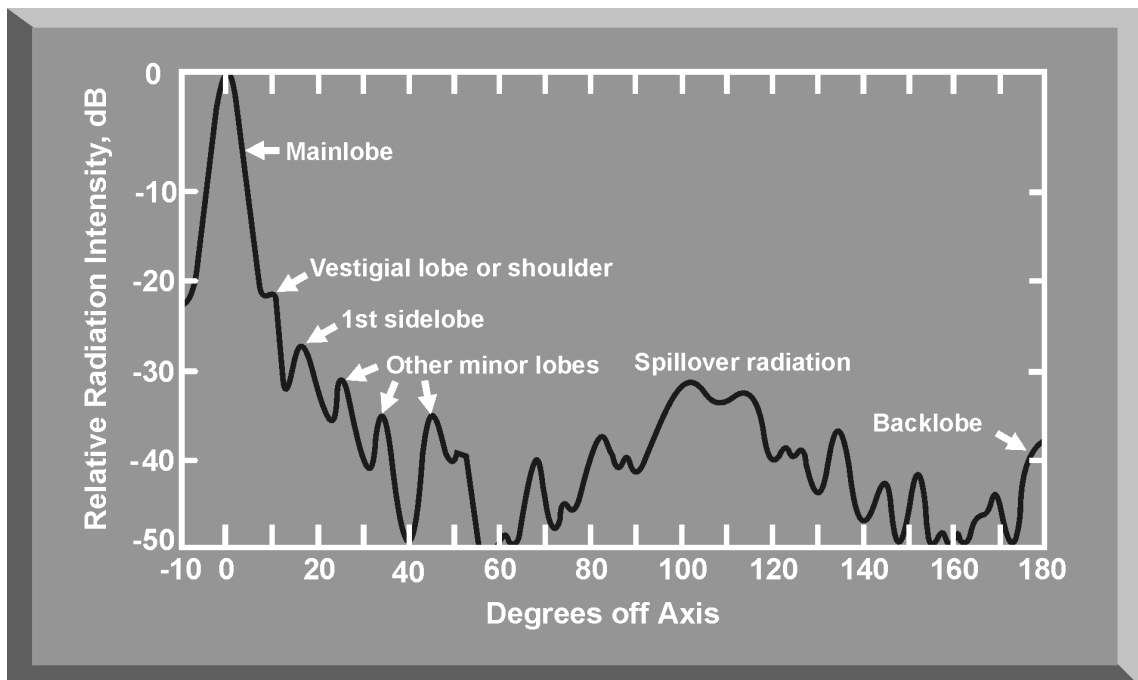

Figure 6-13. Radiation Pattern for a Parabolic Antenna

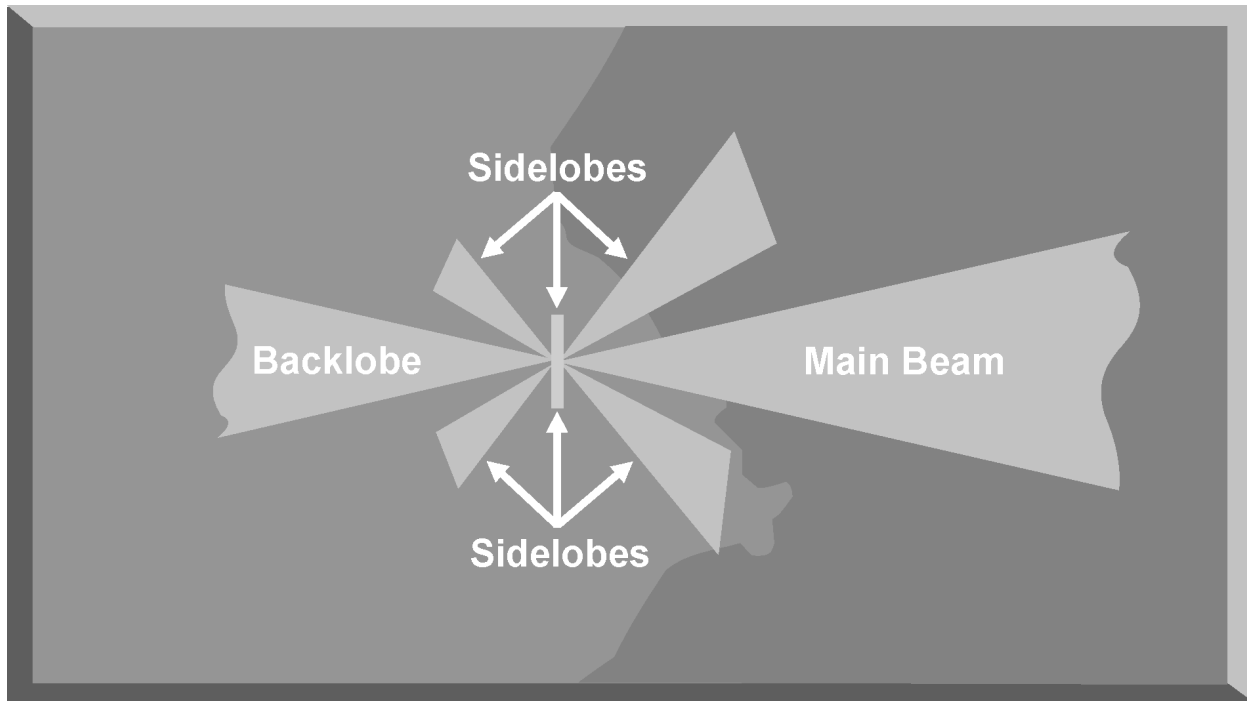

Figure 6-14. Radar Antenna Pattern

a. All radars have a primary main beam, which is where the radar has the most power and where target detection usually occurs. The dimensions of this main beam are highly dependent on the design of the antenna.

b. Besides the main beam, all radars have what is called a backlobe. This lobe is directly opposite to the location of the main beam. The sensitivity and signal strength associated with the backlobe is significantly less than that in the main beam.

c. Sidelobes add another dimension to the radar pattern. As with the backlobe, sidelobes do not have the signal strength or sensitivity associated with the main beam. Normally, the sensitivity associated with the sidelobes is 40-50 decibels (dBs) less than the main beam. The radar signal weakness in the backlobe and sidelobes of the main beam make these areas of the radar signal vulnerable to jamming. It is much easier to introduce jamming into these areas because of the reduced jamming-to-signal ratio needed to be effective. It is difficult for jamming to be effective in the main beam because the radar signal is very powerful in that region.

7. CIRCULAR SCAN

A circular scanning radar uses an antenna system that continuously scans 360° in azimuth (Figure 6-15). The time required for the antenna to sweep one complete 360° cycle is called the scan rate. Scan duration is the number of “hits per scan,”

or the number of pulses, reflected by a target as the radar beam crosses it during one full scan. Most pulse radars require 15 to 20 hits per scan to obtain sufficient information to display a target. The factors that determine the number of hits per scan the radar receives include pulse repetition frequency (PRF), antenna beamwidth, and scan duration.



Figure 6-15. Circular Scan Radar

a. Circular scan radars provide accurate target range and azimuth information. This makes these radars ideal for the roles of early warning and initial target acquisition. To accomplish these missions, the antenna generates a fan beam that has a large vertical beamwidth and a small horizontal beamwidth. Since elevation information will normally be provided by height finder radars, the size of the vertical beamwidth is not a limitation. This antenna scan allows the radar to scan large volumes of airspace for early target detection. Since early detection is the primary goal of early warning radars, accurate altitude and azimuth resolution are secondary considerations.

b. Circular scan radars designed for early warning transmit a radar signal with a low PRF. A low PRF allows sufficient time for the radar pulse to travel long distances, and return, before another pulse is transmitted. This gives the radar system a long, unambiguous range capability. Circular scan radars with low PRFs generally use long pulse widths in order to increase their average power and long-range detection capability. The scan durations of early warning radars are relatively long to provide the required “hits per scan” for long-range target

detection. The plan position indicator (PPI) scope display is normally used with a circular scan radar (Figure 6-16).

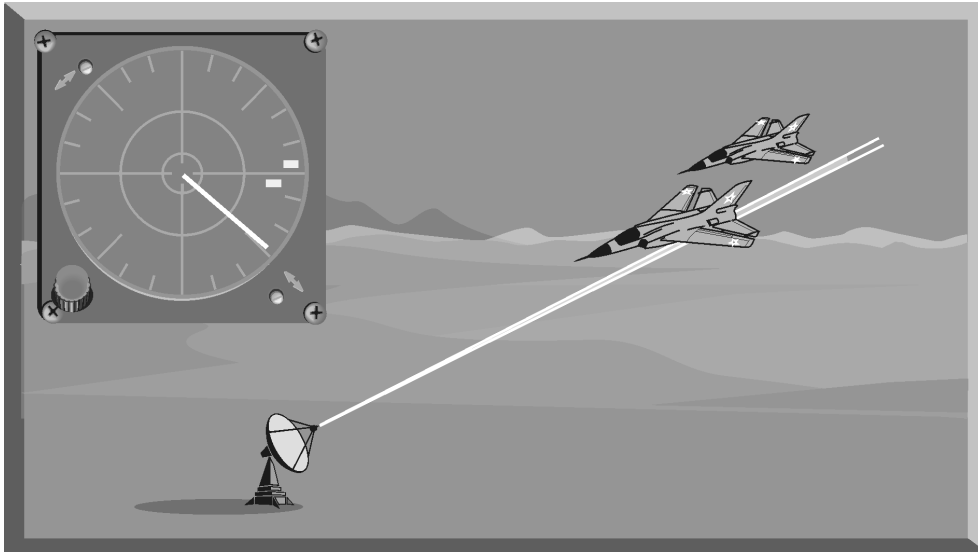

Figure 6-16. PPI Scope Display

c. In order to provide coverage for a large volume of airspace, the beamwidth associated with a circular scan radar is relatively wide. This wide beamwidth, coupled with the long pulse width and low PRF, gives the circular scan radar a large resolution cell, especially at long ranges (Figure 6-17). This limitation can be exploited to mask force size and composition. However, as range decreases, the dimensions of the resolution cell decrease, and a circular scan radar will begin to break out target formations.

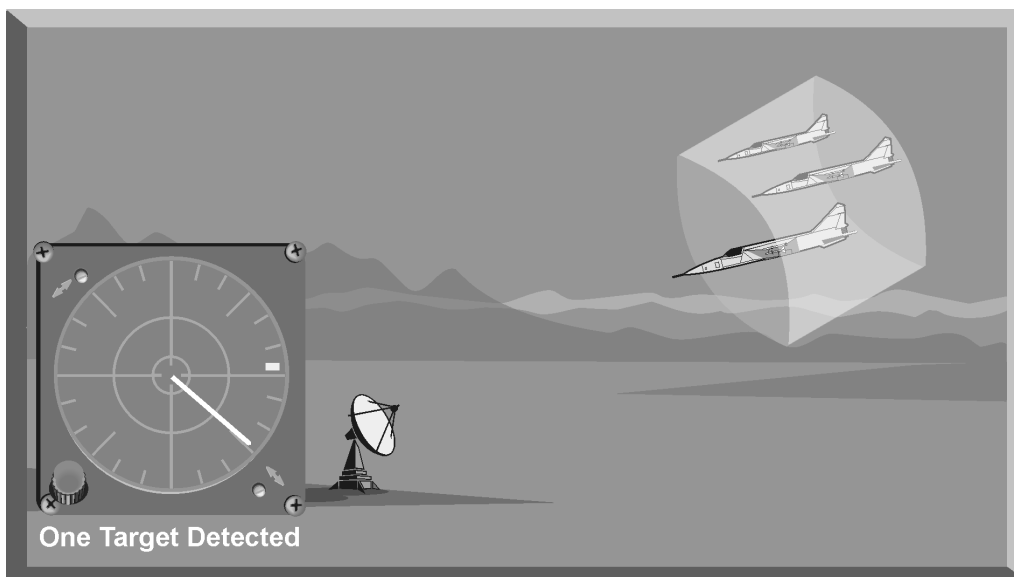

Figure 6-17. Resolution Cell

d. Circular scan radars provide range and azimuth information for both early warning and acquisition roles. Modified circular scan radars that can also provide elevation information may be used for ground control intercept (GCI) roles. Two modified circular scan radars that determine range, azimuth, and elevation are the V-beam and the stacked beam.

(1) The V-beam radar transmits two fan-shaped beams that are swept together (Figure 6-18). A vertical beam provides range and azimuth information. A second beam, rotated at some convenient angle, provides a measure of the altitude of the target.

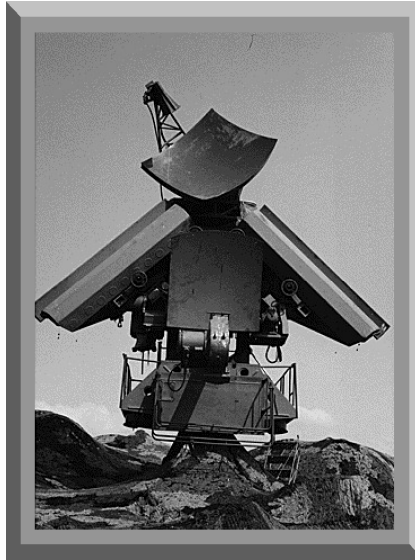

Figure 6-18. V-Beam Radar

(2) A stacked beam radar (Figure 6-19) employs a vertical stack of fixed elevation “pencil” beams which rotate 360°. Elevation information is obtained by noting which beam contains the target return. Range and azimuth information is determined in the same manner as in an early warning radar.

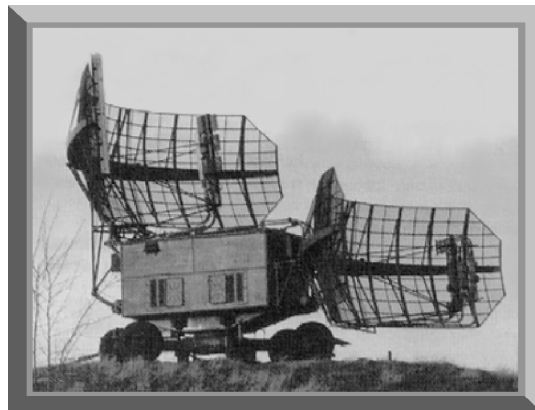

Figure 6-19. Stacked Beam Radar

8. LINEAR SCAN

Linear scan is a method used by some radar systems to sweep a narrow radar beam in a set pattern to cover a large volume of airspace. Linear scans can be oriented in a vertical direction for height finder radars or in a horizontal direction, or raster, for acquisition and target tracking radars. A unidirectional linear radar scans in a single direction then begins its sweep all over again (Figure 6-20). Generally, linear scans offer excellent single-axis coverage, and the narrow beam offers enhanced azimuth and elevation resolution.

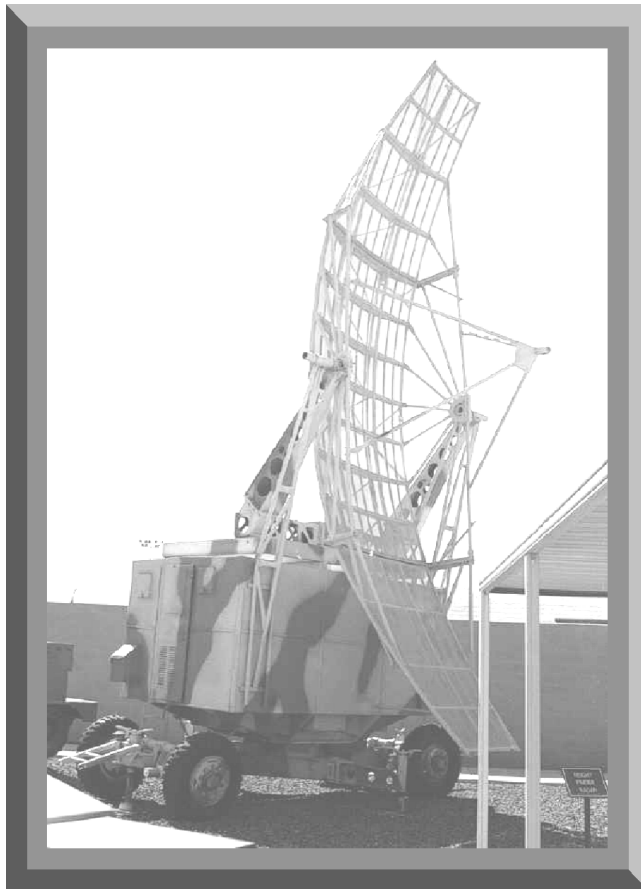

Figure 6-20. Unidirectional Linear Scan

9. UNIDIRECTIONAL SCAN

A helical scan is a unidirectional scan pattern that allows a “pencil” beam to search a 360° pattern. In Figure 6-21, the antenna sweeps a 360° sector in a clockwise direction. After each complete revolution, the antenna elevation is increased. This scan pattern is repeated for a specified number of revolutions, in this case, three, 360° sweeps. At the end of the scan pattern, the antenna elevation is reset to the initial elevation and the scan is repeated. A helical scan pattern is commonly used as a target acquisition mode for radar systems with narrow vertical and horizontal beamwidths.

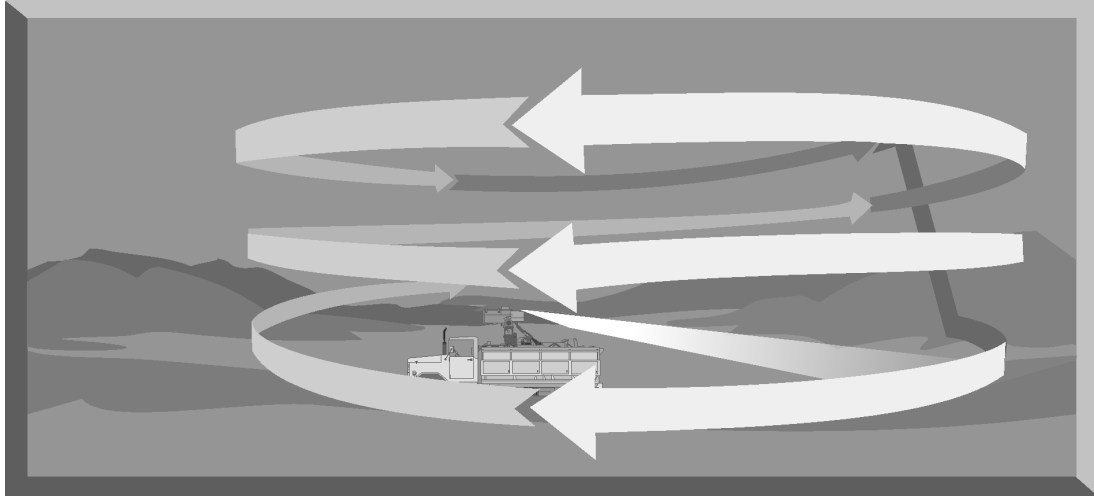

Figure 6-21. Helical Scan

10. BIDIRECTIONAL SCAN

A bidirectional linear scan, such as a raster scan, sweeps both horizontally and vertically (Figure 6-22). A raster scan uses a thin beam to cover a rectangular area by horizontally sweeping the area. The angle of elevation is incrementally stepped up or down with each horizontal sweep of the desired sector. After the sector has been covered, the angle of elevation is reset to the original value and the process is repeated. The number of raster bars is set by the number of horizontal sweeps in the basic raster pattern. Figure 6-22 shows a four-bar raster scan, which is normally associated with an airborne interceptor (AI) radar.

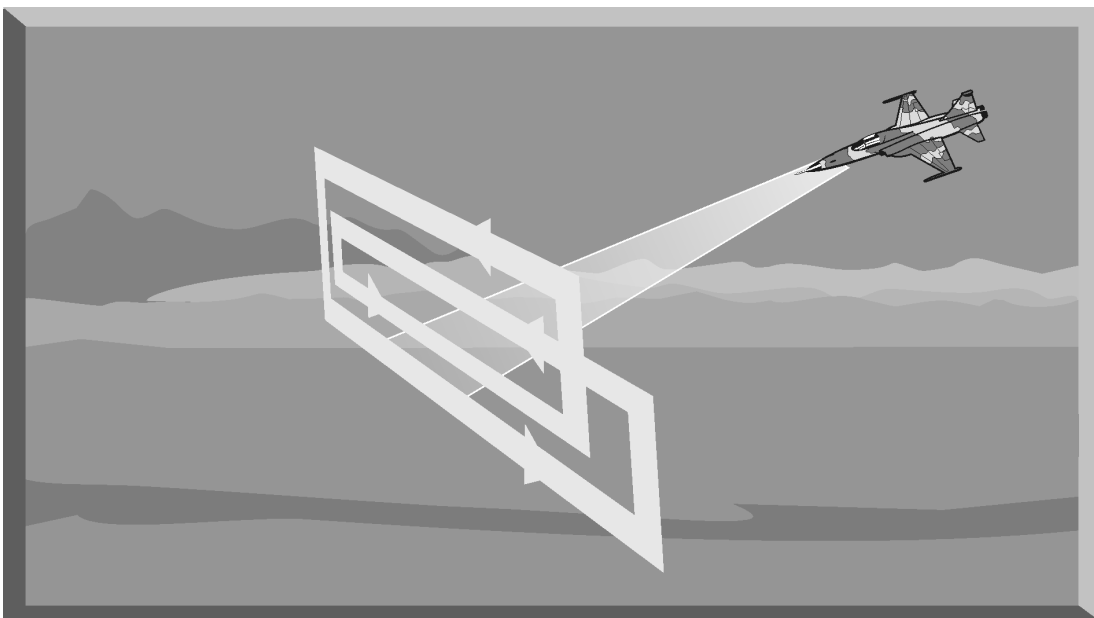

Figure 6-22. Raster Scan

11. CONICAL SCAN

A conical scan, or conscan, radar is generally used for precision target tracking. A conical scan radar (Figure 6-23) employs a pencil beam of radar energy that is continuously rotated around the target. This circular rotation of a pencil beam generates a cone-shaped scan pattern with the apex of the cone located at the antenna. Thus, the name conical scan.

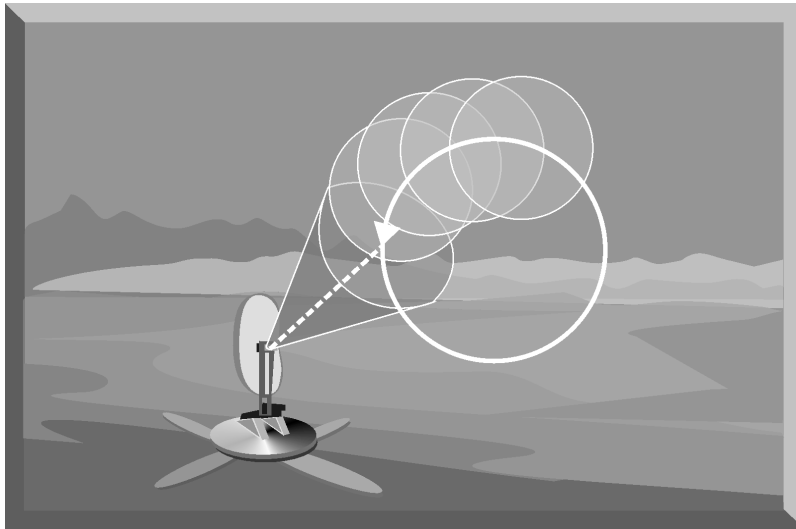

Figure 6-23. Conical Scan

a. As the pencil beam rotates, the circular scan patterns overlap in the center. This creates a central tracking area that has a much smaller effective beamwidth than the rotating pencil beam (Figure 6-24). This results in a very precise tracking solution.

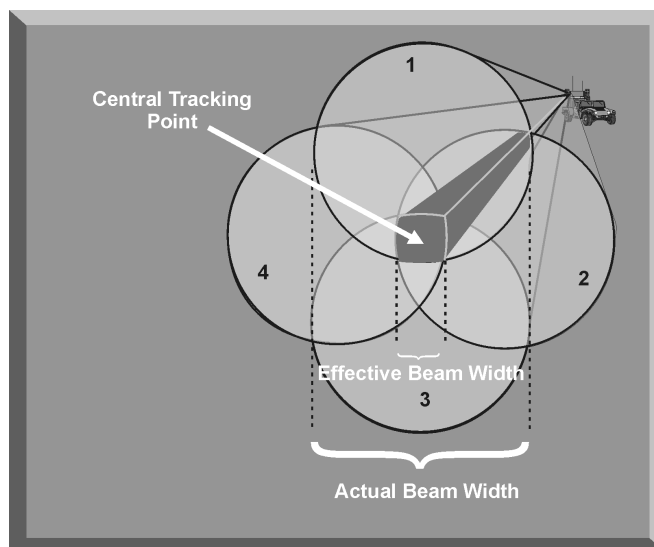

Figure 6-24. Conical Scan Tracking Area

b. Since conical scan radars are designed for precision target tracking, these radars normally operate at high frequencies, high PRF, narrow pulse widths, and narrow beamwidths. The rotation rate of the pencil beam can exceed 1,800 revolutions per minute. This means that both azimuth and elevation data can be updated about 30 times per second.

c. The combination of conical scan and raster scan is called a Palmer-raster scan (Figure 6-25). A Palmer-raster scan uses a thin beam, employing a conical scan searching pattern, for a specific sector of airspace. With each sweep of the sector, the angle of elevation is incrementally stepped up or down. After the vertical sector has been covered, the angle of elevation is set at the original elevation and the process is repeated. The number of bars is determined by the number of vertical search scans.

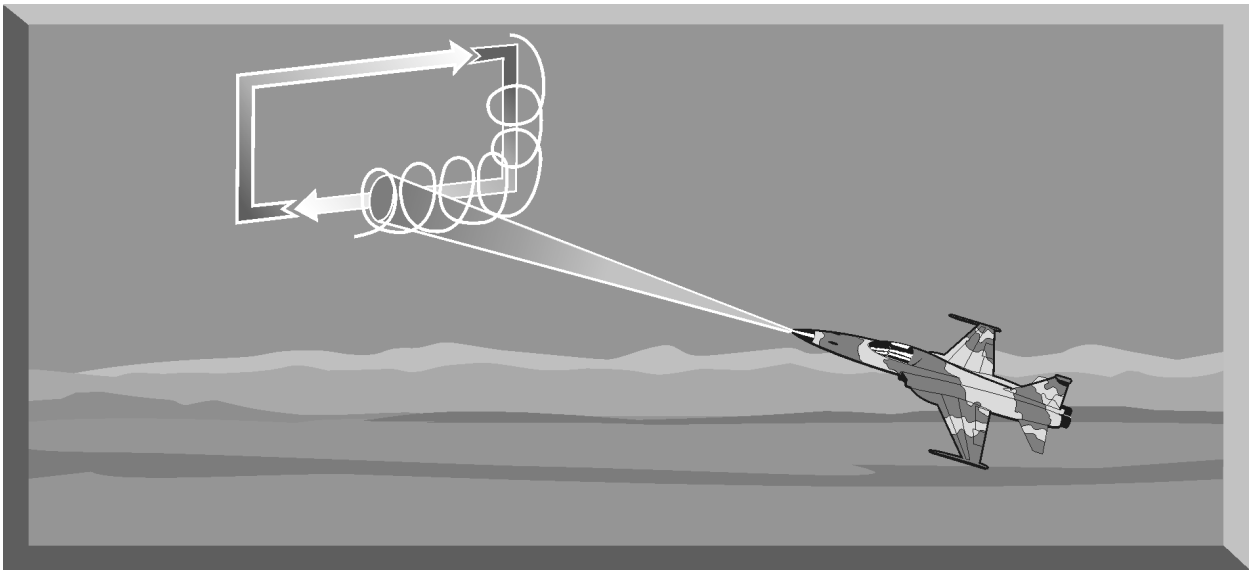

Figure 6-25. Palmer-Raster Scan

d. The combination of a conical scan and a circular scan is called a Palmer scan. Palmer scans incorporate a circular scanning antenna to search the entire horizon while simultaneously performing a conical scan. If the radar antenna is also performing a unidirectional altitude search in conjunction with this scan, it is employing a Palmer-helical scan (Figure 6-26).

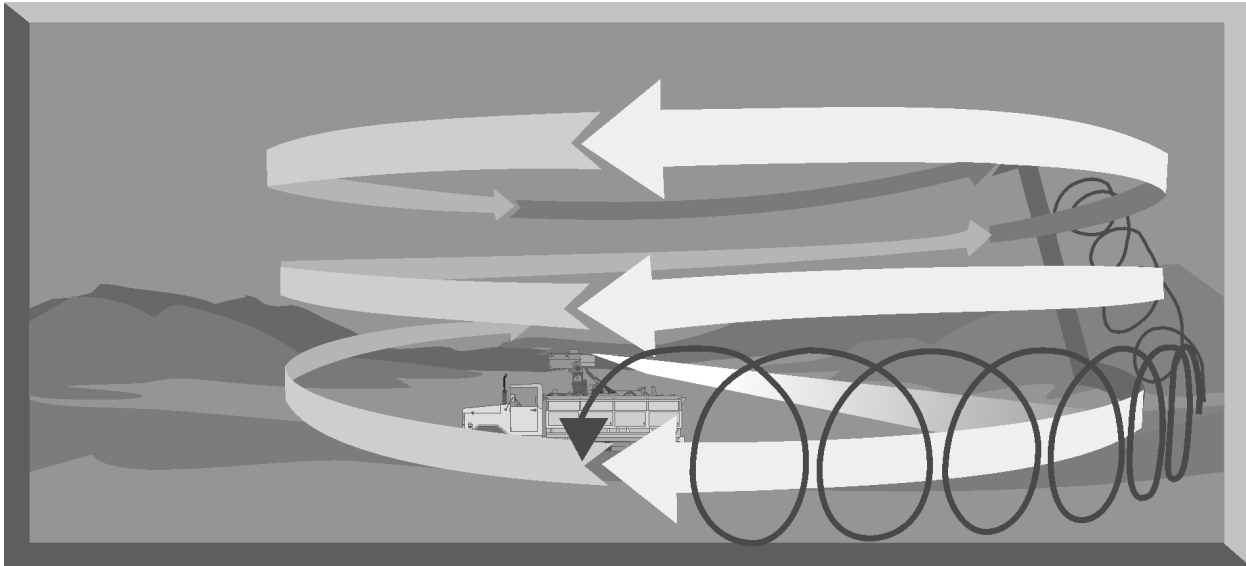

Figure 6-26. Palmer-Helical Scan

12. TRACK-WHILE-SCAN

A track-while-scan (TWS) system uses a technique that allows a radar to track one or more targets while scanning for others. Radar systems with a TWS capability must be able to generate two or more distinct radar beams.

a. A conventional TWS radar employs two antennas that work with each other to perform the scan function (Figure 6-27). Each antenna produces a separate unidirectional beam. Each beam is transmitted at a different frequency. The vertical antenna generates a beam employing a vertical sector scan similar to a height finder radar except the beamwidth is narrower and it scans at a higher rate. The horizontal antenna generates an identical beam employing a horizontal sector scan at a different frequency. The track function is accomplished in the area where the two beams pass through each other. A target that is within this center area is tracked, and positional information on range, elevation, and azimuth is updated each time the beams sweep through the area.

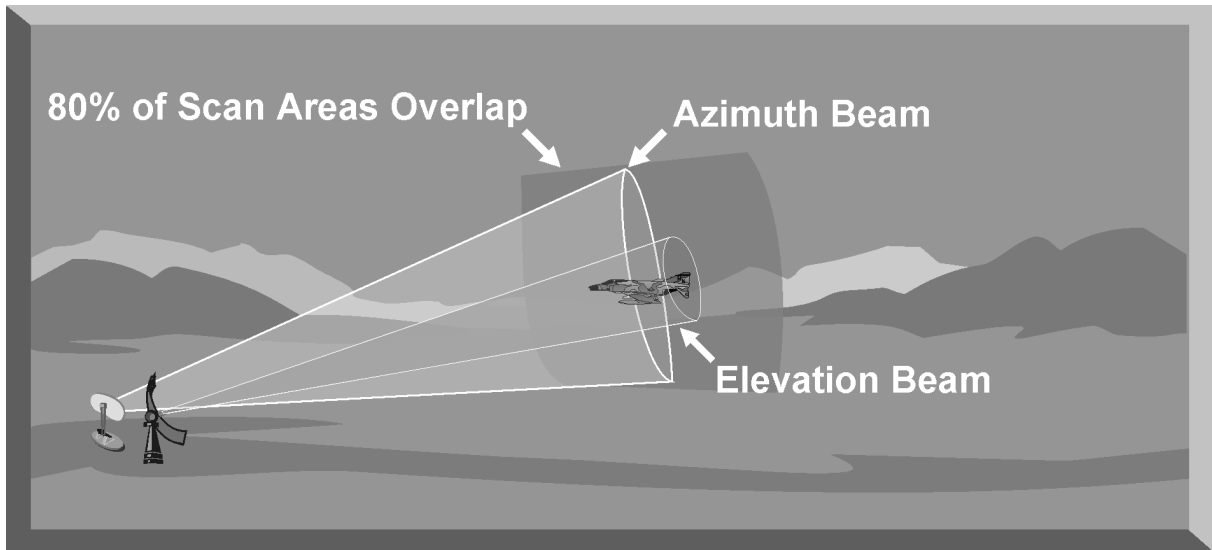

Figure 6-27. Conventional TWS Radar

b. The phased array radar is a product of the application of computer and digital technologies to the field of radar design. A phased array is a complex arrangement of many individual transmitting and receiving elements in a particular pattern (Figure 6-28). Common arrays include linear, planar, curved, and conformal, with linear being the most common. By using a computer to rapidly and independently control groups of these individual elements, a phased array antenna can, in effect, radiate more than one beam from the antenna. Multiple beams and computer processing of radar returns give the phased array radar the ability to perform the TWS function. The most common employment of the TWS capability of the phased array radar is in the air-to-air arena.

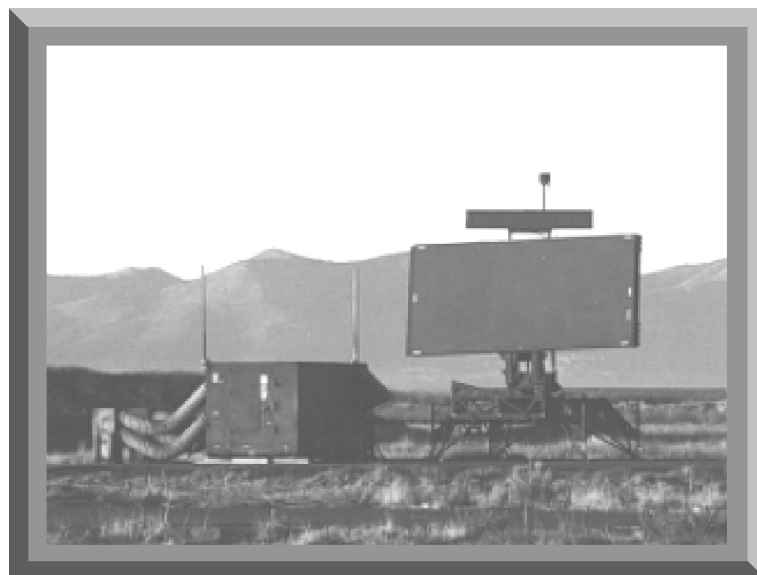

Figure 6-28. Phased Array Antenna

(1) The number of individual transmitting and receiving elements is limited by the size of the radar antenna. The number of targets a phased array radar can track is limited by the number of independent beams the antenna can generate. Many phased array radars, especially air-to-air radars, do not track and scan simultaneously, but rapidly switch between the two modes to overcome this limitation (Figure 6-29).

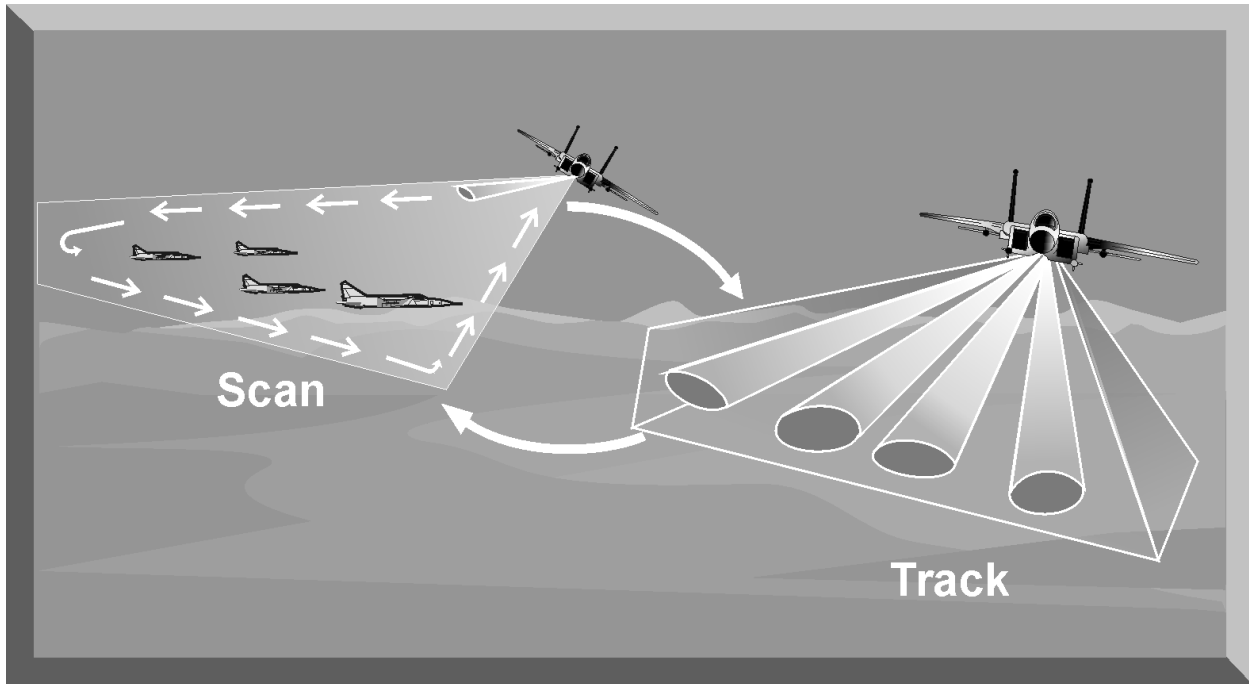

Figure 6-29. Phased Array TWS

(2) Modern TWS radars employ computer signal processing and complex computer algorithms to simplify the problem of target correlation (Figure 6-30). An air-to-air radar typically uses a raster scan to search a volume of airspace. In the search mode, the radar simply presents all targets detected in this airspace to the pilot on his radar display. In the TWS mode, the radar employs computer processing to figure out target correlation and update target information. This is done automatically, and the results are presented on the display.

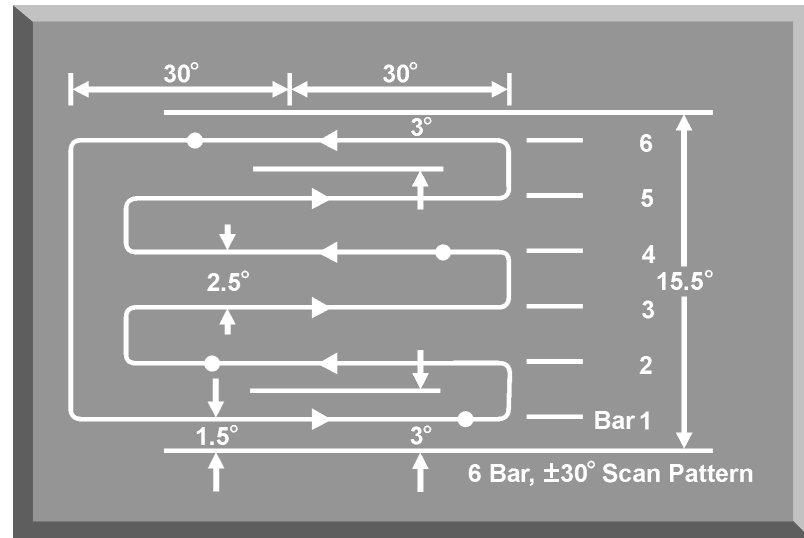

Figure 6-30. Phased Array TWS Radar Display

13. IMPACT OF TERRAIN ON RADAR SCANS

No matter what type of scan a radar system employs, terrain can limit radar line of sight (LOS) and target detection. The concepts of radar horizon, direct terrain masking, and indirect terrain masking are important factors in radar target detection and mission planning.

a. RF waves traveling in the atmosphere are bent, or refracted, and do not travel in a straight line. However, the degree of refraction depends on atmospheric conditions which vary significantly and are difficult to accurately quantify and predict. For these reasons, most radar computations are based on the assumption that RF waves travel in a straight line. The concept of the radar horizon is based on this assumption.

(1) The radar horizon shown in Figure 6-31 is the maximum range a radar system can detect a target due to the curvature of the earth. The distance (d) to the horizon for a radar antenna at a height (h) can be computed using Equation 6-6.

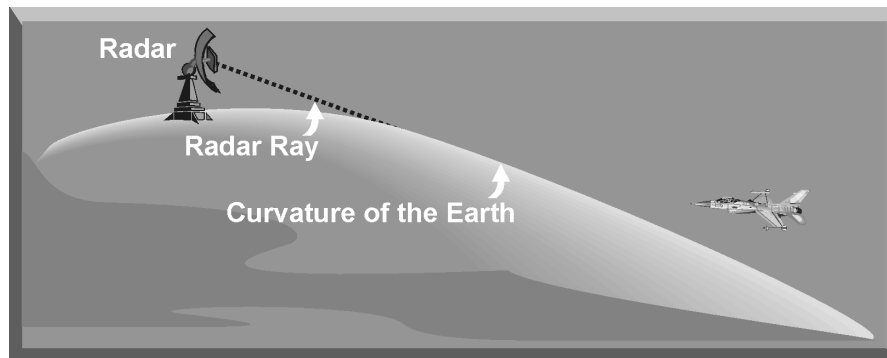

Figure 6-31. The Radar Horizon

$$\text{Distance to Horizon (d)} = \sqrt{2k ah}$$

k = constant (4/3)

a = radius of earth

h = height of radar antenna

Equation 6-6. Basic Radar Horizon Equation

(2) In Equation 6-6, the constant, k , is commonly used to compensate for the assumption of straight line propagation of RF waves. Using the assumption that the height of the radar antenna is small compared to the radius of the earth, distance is measured in nautical miles (nm), and height is measured in feet, then Equation 6-6 reduces to Equation 6-7.

$$\text{Distance to Horizon (d)} = 1.06 \sqrt{h}$$

Equation 6-7. Simplified Radar Horizon Equation

(3) Another application of Equation 6-7 is in calculating the range at which a radar antenna will achieve LOS with a low-altitude target. To compute this distance (D), Equation 6-8 can be used.

$$\text{Target Detection Distance (D)} = 1.06 (\sqrt{h} + \sqrt{\text{target altitude}})$$

Equation 6-8. Target LOS Distance

(4) To illustrate the use of Equations 6-7 and 6-8, consider the example of a radar antenna located at a height of 25 feet and a target aircraft flying at an altitude of 100 feet. From Equation 6-7, the radar horizon for this system would be 5.3 nm. From Equation 6-8, the radar antenna will have LOS with the target aircraft at 16 nm.

b. The previous discussions of the radar horizon assumes the radar is operating over water or level terrain. Radar operations over rough terrain can present other radar LOS limitations. As illustrated in Figure 6-32, prominent terrain features can limit radar detection. In this illustration, a mountain acts as a radar horizon and limits target LOS in one sector of the radar scan. This situation is called direct terrain masking. Placing prominent terrain features between the aircraft and threat radar systems effectively negates these systems and is an integral part of threat avoidance during combat mission planning.

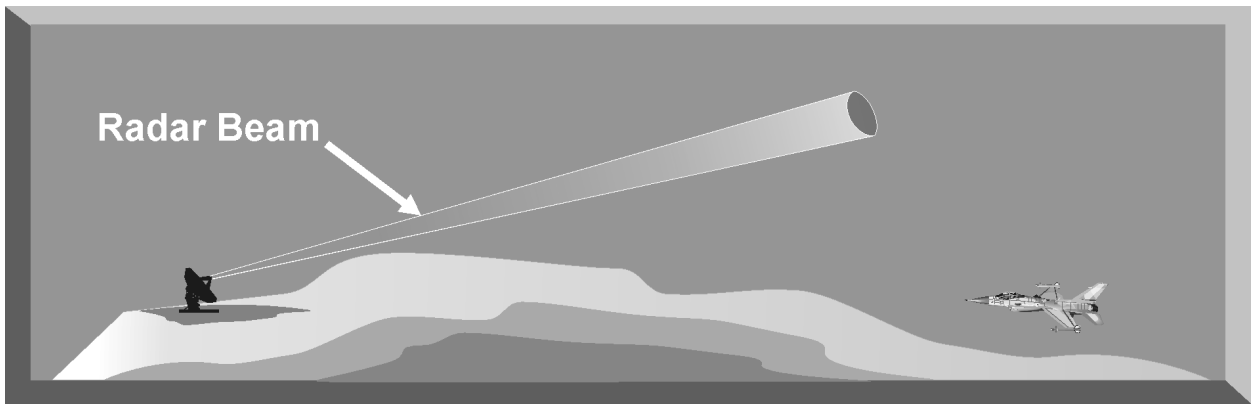

Figure 6-32. Direct Terrain Masking

c. Figure 6-33 depicts another impact of terrain on target detection/indirect terrain masking. When both the aircraft and a prominent terrain feature are illuminated by a radar beam, a pulse radar system may not be able to differentiate the target return from the return generated by the terrain. Indirect terrain masking is most effective when the aircraft is flying abeam the radar site. Pulse Doppler radars and radar systems employing moving target indicator (MTI) circuits may be able to negate the effectiveness of indirect terrain masking. However, indirect terrain masking is another important consideration for threat avoidance during combat mission planning.

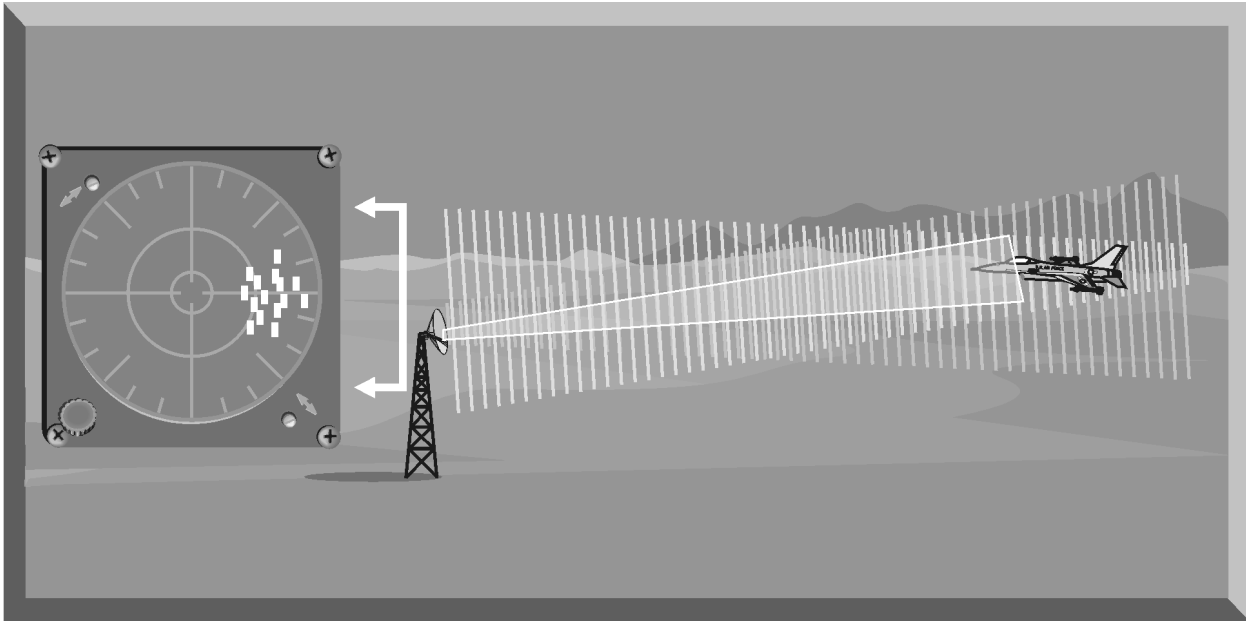

Figure 6-33. Indirect Terrain Masking

14. SUMMARY

This chapter has introduced basic antenna characteristics and how these characteristics influence their employment. The concepts of antenna gain and power density were also explained. The remainder of the chapter discussed the different types of radar scans. A radar's scan pattern is designed to enhance target detection and facilitate target tracking. The radar horizon, direct terrain masking, and indirect terrain masking are LOS limitations to all radar scans. The scan pattern chosen for a specific radar system determines the ability of that radar to provide accurate range, azimuth, elevation, or velocity of the detected target.

CHAPTER 7. TARGET TRACKING

1. INTRODUCTION

A target tracking radar (TTR) is designed to provide all the necessary information to guide a missile or aim a gun to destroy an aircraft. Once a target has been detected, either by a dedicated search radar or by using an acquisition mode, the TTR is designed to provide accurate target range, azimuth, elevation, or velocity information to a fire control computer.

a. A typical TTR has individual tracking loops to track a target in range, azimuth, elevation, or velocity. The antenna of the TTR is pointed at a single target, and the radar initiates acquisition and target track. TTRs normally employ automatic trackers to continuously measure target data. The range tracking loop employs an early gate/late gate range tracker to maintain automatic range tracking. The azimuth and elevation tracking loops generate error signals to position the antenna and maintain constant target illumination. The velocity tracking loop found on pulse Doppler and CW radars is used to reject clutter and generate accurate target radial velocity information. All this critical information is passed to a fire control computer for weapons employment.

b. The fire control computer is programmed with critical information on the capability of the weapon to be employed. For a missile, the fire control computer is programmed with the aerodynamic and range capabilities of the missile. For anti-aircraft artillery (AAA), the fire control computer is programmed with the ballistics for the gun, rate of fire, and tracking rate. The fire control computer uses the precise target information from the TTR and the programmed weapon's parameters to compute a firing solution. Once a firing solution has been computed, the fire control computer either fires the weapon automatically or alerts the operator, who fires the weapon. For missile employment, the fire control computer may continue to provide missile guidance and fusing commands until missile impact or initiation of an active missile guidance mode. For AAA engagement, the fire control computer computes the required lead angle, aims the guns, and initiates firing.

c. To provide the required azimuth and elevation resolution, most TTRs use a high frequency to provide narrow antenna beamwidths for accurate target tracking. High frequency operation also allows the radar to transmit wide bandwidths. To provide the required range resolution, most TTRs employ narrow pulse widths and high pulse repetition frequencies (PRFs) to rapidly update target information. In this chapter, the target tracking techniques of conical scan, track-while-scan, lobe-on-receive-only, monopulse, Doppler radars, and pulse Doppler radars will be discussed.

2. RANGE TRACKING

In most TTR applications, the target is continuously tracked in range, azimuth, and elevation. Range tracking can be accomplished by an operator who watches an “A” scope presentation and manually positions a handwheel to maintain a marker over the desired target return. The setting of the handwheel is a measure of target range and is converted to a voltage used by the fire control computer. As target speeds and maneuvers increase, the operator may have extreme difficulty maintaining manual target range tracking. To avoid this situation, most TTRs employ an automatic range tracking loop. All pulse TTRs, which includes conical scan, track-while-scan, monopulse, and pulse Doppler radars, employ either a split gate or leading-edge automatic range tracking system. In a TTR, automatic range tracking serves two essential functions: (1) it provides the critical value of target range, and (2) it provides a target acceptance range gate that excludes clutter and interference from other returns. Since radar range is normally the first target discriminator used to initiate automatic target tracking, the second function is essential to the proper operation of the other tracking loops.

a. A range gate circuit is simply an electronic switch that is turned on for a period of time after a pulse has been transmitted. The time delay for switch activation corresponds to a specific range. Any target return that appears inside this range gate is automatically tracked. The most common type of automatic range tracking is accomplished by a split-gate tracker. Two range gates are generated as shown in Figure 7-1. The automatic range tracking loop attempts to keep the amount of energy from the target return in the early gate and late gate equal. The range tracking error is computed by subtracting the output of the late gate from the output of the early gate. The amount of the range tracking error signal is the difference between the center of the pulse and the center of the range gate. The sign of the error signal determines the direction in which the gates must be repositioned to continue to track the target.

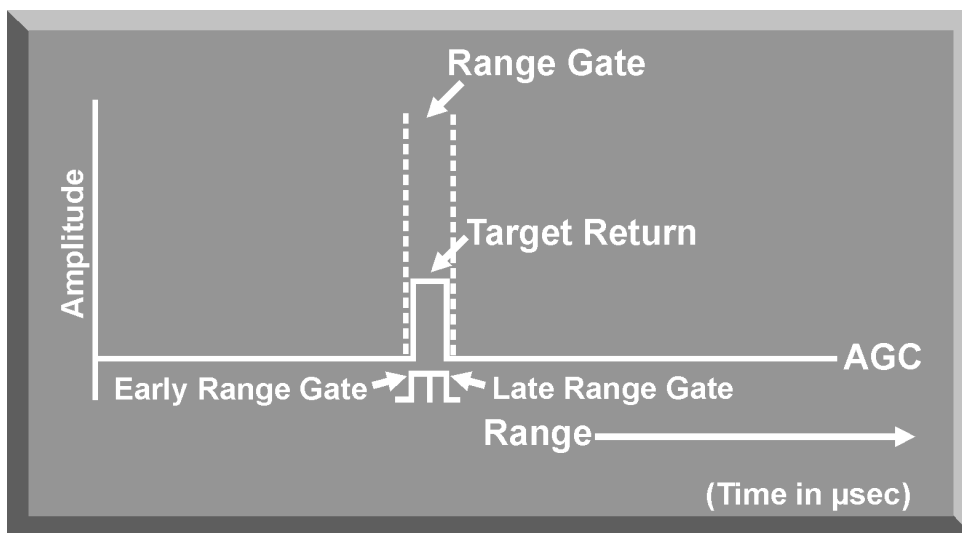

Figure 7-1. Split-Gate Range Tracker

b. Leading-edge range tracking is an electronic protection (EP) technique used to defeat range-gate-pull-off (RGPO) jamming. Figure 7-2 illustrates the application of leading-edge tracking. The leading-edge tracker obtains all range data from the leading edge of the target return. All RGPO cover pulse jamming tends to lag the target return by some increment of time (see (a) in Figure 7-2). By differentiating the entire return with respect to time, the target return can be separated from the jamming pulse (see (b) in Figure 7-2). Employing a split-gate tracker electronically positioned at the initial pan, or leading edge, of the returning pulse, the range tracking loop can track the target return and ignore any jamming signals. The range tracking loop then uses split-gate tracking logic to determine the magnitude and direction of range tracking errors and reposition the range gate.

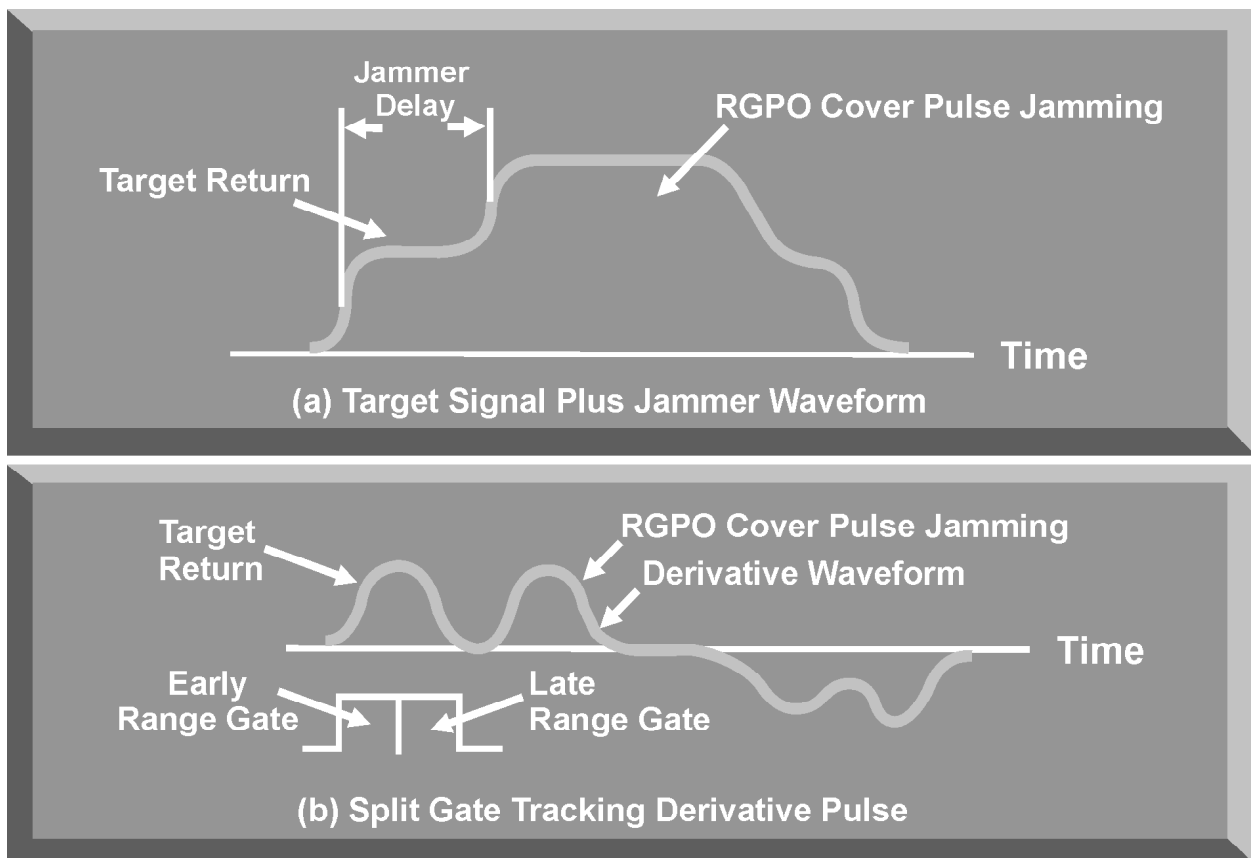

Figure 7-2. Leading-Edge Range Tracker

c. The width of the tracking gate is an important radar design consideration. The range gate should be sufficiently narrow to effectively isolate the target from other returns at different ranges. It should be wide enough to allow sufficient energy from the target echo to be displayed. The width of the range tracking gate is normally equal to the pulse width of the radar.

d. Nearly all range tracking gates employ some form of automatic gain control (AGC). AGC is designed to limit target clutter and glint. It is also designed to avoid excessive false alarms.

3. CONICAL SCAN

A conical scan tracking system is a special form of sequential lobing. Sequential lobing implies that the radar antenna beam is sequentially moved between beam positions around the target to develop angle-error data. For a conical scan radar to generate azimuth and elevation tracking data, the beam must be switched between at least four beam positions as shown in Figure 7-3.

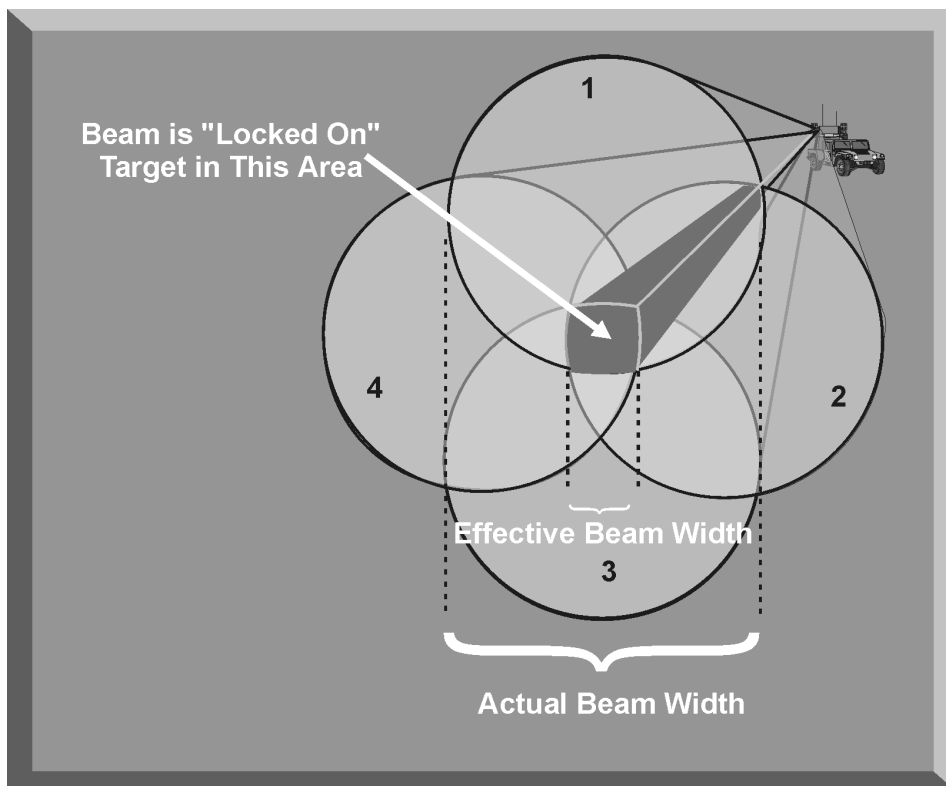

Figure 7-3. Conical Scan Positions

a. One of the simplest conical scan antennas is a parabola with an offset rear feed that rotates, or nutates, to maintain the plane of signal polarization. The radar beam is rotated at a fixed frequency around the target. The angle between the axis of rotation (normally the axis of the antenna) and the axis of the antenna beam is called the squint angle.

b. A conical scan radar first tracks the target aircraft in range. For azimuth and elevation tracking, the target return is modulated at a frequency equal to the rotation frequency of the radar beam. This results in a target signal output that resembles a sine wave (Figure 7-4). The azimuth and elevation tracking loops

drive servo motors to position the antenna to keep the energy level in each of the four positions equal. The amount of the modulated signal determines how far the target is off the antenna boresight while the phase of the modulation (positive or negative) determines the direction.

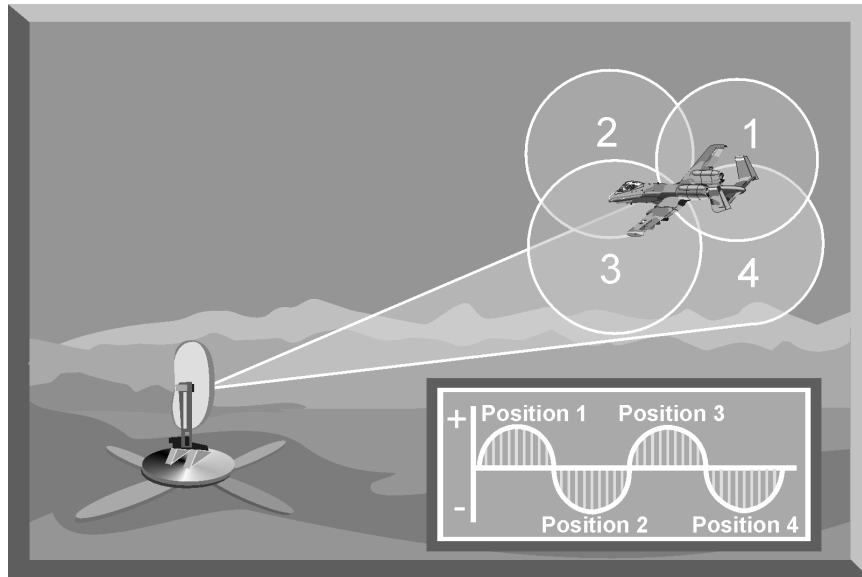

Figure 7-4. Conical Scan Modulation

c. In Figure 7-5, most of the target energy is in position 1, with a small amount of energy in position 4. The output from the elevation tracking loop is positive and drives the antenna servos upward. The output from the azimuth tracking loop moves the antenna to the right.

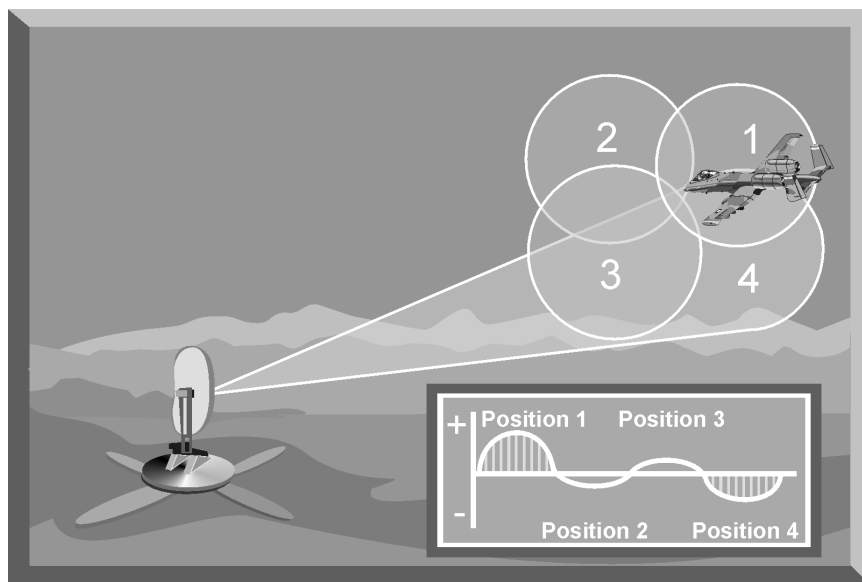

Figure 7-5. Conical Scan Tracking Errors

d. Once a balance of target energy in each scan position is achieved, the target is in the central tracking area (Figure 7-6). The azimuth and elevation tracking circuits continue to drive the antenna servos to maintain this energy balance which keeps the radar beam on the target.

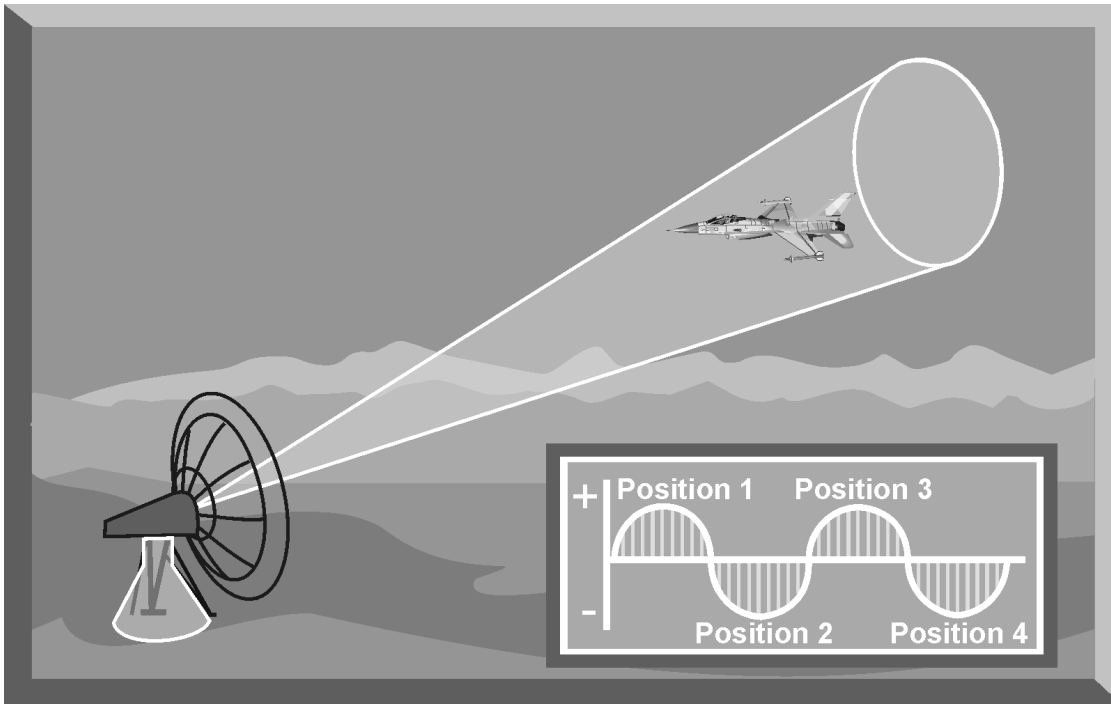

Figure 7-6. Conical Scan Tracking

e. The primary advantage of a conical scan radar is the small beamwidth which provides extremely accurate target tracking information. The primary disadvantages of conical scan include the following: (1) the narrow beamwidth makes target acquisition a problem. Even using a Palmer-helical scan, it may take considerable time to find and initiate track on a target; (2) conical scan radars are vulnerable to inverse gain modulation jamming based on the scanning frequency of the rotating beam; (3) a conical scan radar must analyze many radar return pulses to generate a tracking solution.

4. TRACK-WHILE-SCAN (TWS)

TWS is a combined search and tracking mode that sacrifices the continuous target observation capability of the dedicated tracker in return for the ability to monitor a finite sector of airspace. This is accomplished while maintaining tracks on multiple targets moving through the covered airspace. There are two types of radar systems capable of TWS operation: conventional and phased array.

a. Conventional track-while-scan threat radars use two separate antennas to generate two separate beams (Figure 7-7). These beams operate at two different

frequencies and are sectored so they overlap the same region of space. This overlap area provides a tracking area for a single target. One beam is sectored in the vertical plane to give range and elevation. The other beam is sectored in the horizontal plane to provide range and azimuth. Each beam scans its sector at a rate of 5 to 50 times per second. This provides a rapid update on target range, azimuth, and elevation.

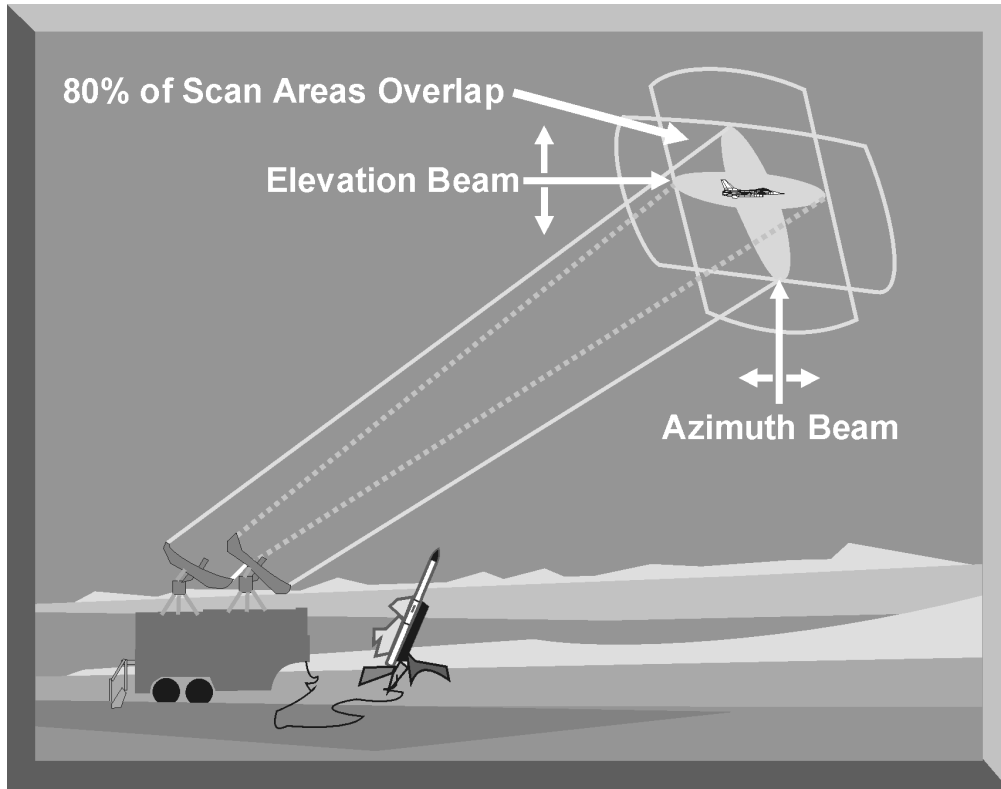

Figure 7-7. Conventional TWS Radar Beams

(1) The two TWS antennas generate their beams using an electro-mechanical principle. Each antenna provides inputs to its own display and provides angle and range information for all targets in the coverage of the radar. The display from the elevation beam is calibrated in range and elevation, while the display from the azimuth beam is calibrated in azimuth and range. Operators position a cursor over the returns on these displays using range as the primary parameter. Once a target has been designated for engagement, the radar automatically attempts to keep the tracking axis of the radar beams centered on the target.

(2) Once the target is designated by the operator, the range gate is enabled and tracks the target using a split-gate tracker. The azimuth and elevation tracking loops receive information only from targets inside the range gate. As the beams scan across the target, a burst of pulse returns is received that have an

amplitude envelope corresponding to the beam pattern. The azimuth beam pattern is shown in Figure 7-8.

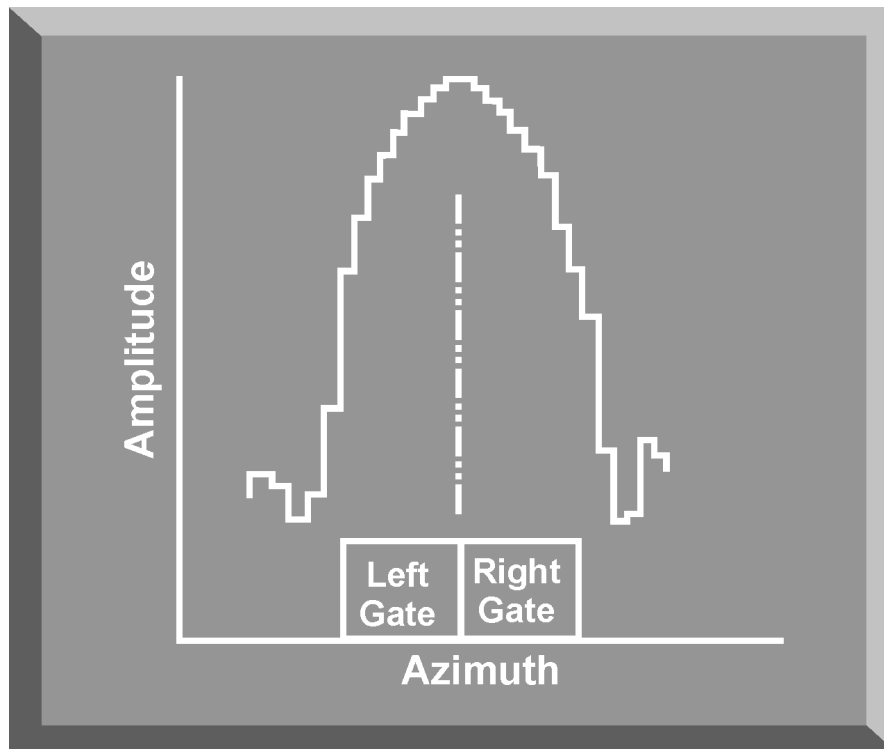

Figure 7-8. Conventional TWS Azimuth Tracking

(a) The azimuth tracker is typically a split-gate tracker, identical in concept to a split-gate range tracker. However, range delay time is replaced by azimuth scan time. The azimuth tracker uses a left gate and right gate. Each gate integrates its share of the target return to generate a voltage/time value. When the azimuth gate is centered on the target, the areas are equal and the error signal (right gate minus left gate) is zero. The azimuth tracking loop sends signals to the antenna servos to keep the target centered in the scan area.

(b) Elevation tracking is accomplished in the same manner by using an up gate and a down gate. The elevation tracking loop also sends signals to the antenna servos to keep the target centered in the scan area.

(3) Once the target is designated and the radar is automatically keeping the radar return centered in the tracking area, target range, azimuth, and elevation information is sent to a fire control computer. The radar continues to provide information on other targets in the scan area. The fire control computer indicates the firing solution has been achieved for the designated target, and a missile is launched. The radar tracks the target and the missile and provides in-flight corrections to the missile right up to the moment of missile impact. These corrections are based on both target and missile azimuth, range, and elevation

information. Information is passed to the missile from a dedicated antenna on the radar to special antennas on the missile. Commands from the radar to the missile are called uplink guidance commands. Information from the missile back to the radar and fire control computer is called downlink information.

(4) The advantages of a conventional TWS radar include the following: (1) TWS radars have the ability to maintain radar contact with all targets in the sector scan area while maintaining target track on a single target, and (2) the rapid sector scan rate provides a rapid update on target parameters. The primary disadvantages of a conventional TWS radar include: (1) a large resolution cell due to the wide azimuth and elevation beams, and (2) vulnerability to modulation jamming based on the scan rate of the independent beams.

b. Many modern radars employing a planar or phased array antenna system have a TWS mode. The radar does not really track and scan simultaneously, but rapidly switches between search and track (Figure 7-9).

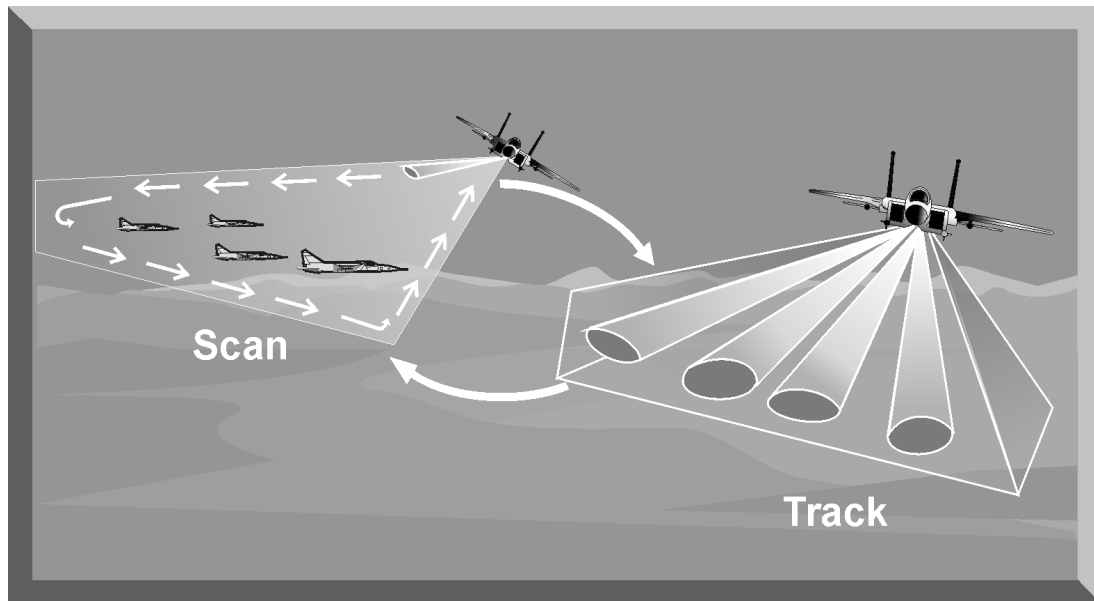

Figure 7-9. Phased Array TWS

(1) The most common air-to-air radar system uses a planar array antenna. In the scan mode, the radar antenna generates a pencil beam and uses a raster scan to detect targets in the search area. Targets detected are presented to the pilot on the aircraft's radar display (Figure 7-10).

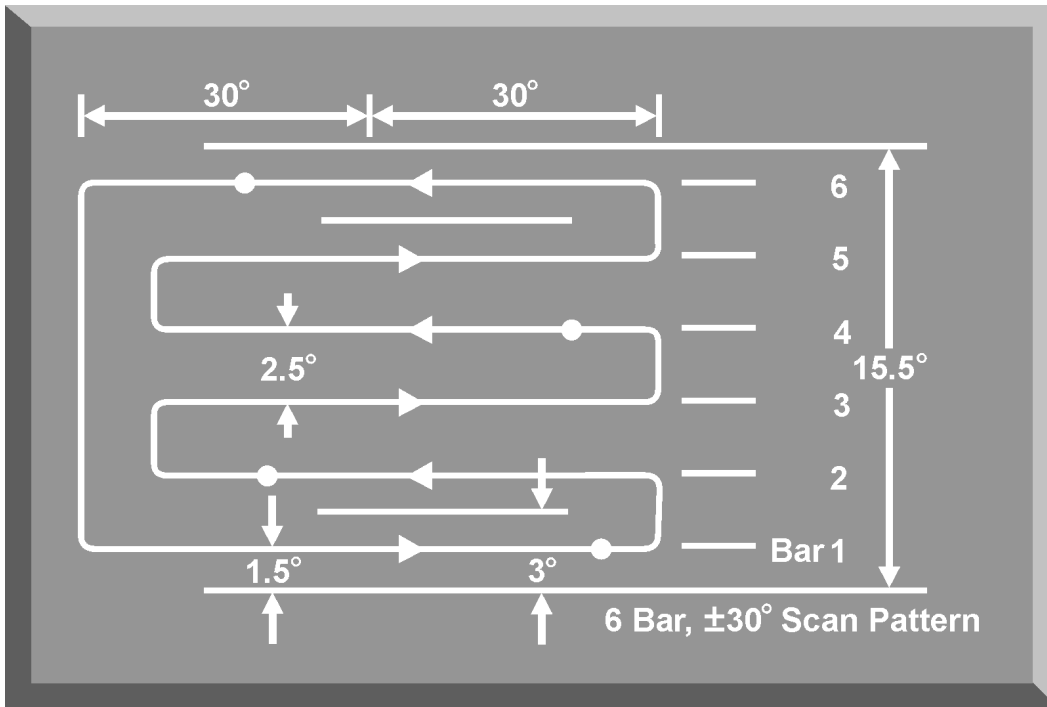

Figure 7-10. Air-to-Air TWS Display

(a) In the track mode, the antenna generates multiple beams to illuminate individual targets. The radar typically uses monopulse or pulse Doppler techniques to update target range, azimuth, elevation or velocity. These tracking techniques will be covered later in this chapter. The radar initiates a track file on each detected target that contains all current data on the target and an estimate of future target position.

(b) As the radar switches between track and scan modes, target parameters are updated in the tracking loop (Figure 7-11). The new target information is compared to the predicted information in the measurement data processing cell. If the two sets of data agree within certain limits, target position and information are updated. This process is called gating.

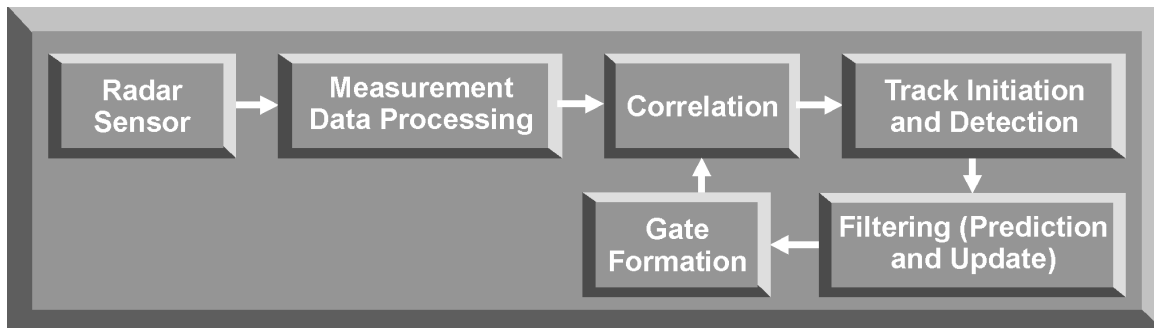

Figure 7-11. Planar/Phased Array TWS Tracking Loop

(c) If the updated target information does not correspond to the predicted values, the information is sent to the correlation processor. The correlation processor attempts to resolve the conflict based on further refinement of target data. If the correlation processor cannot assign the target parameters to an existing track file, a new track file is generated and displayed.

(2) The obvious advantage of a planar/phased array TWS radar is that it can search a large volume of airspace while tracking individual targets. The number of targets that can be tracked is limited by the number of beams the radar can generate. Planar/phased array radars have increased peak and average power when compared to pulse radar systems. Since the radar beam of a planar/phased array radar is electronically controlled and can rapidly change beams and scans, it is resistant to many jamming techniques. The primary disadvantages of a planar/phased array TWS radar include its complexity, cost, and reliance on computer processing.

5. LOBE-ON-RECEIVE-ONLY (LORO)

LORO is a mode of radar operation developed as an EP feature for a track-while-scan radar. LORO can be employed by any radar that has the capability to passively track a target. In a LORO mode, the radar transmits a continuous signal from a set of illuminating antennas. This continuous signal hits the target, and the return echo is received by a different set of receive antennas (Figure 7-12). The receive antennas are passive and generate azimuth and elevation tracking signals by electronically scanning the reflected signal. The tracking signals are sent to the antenna servos to keep the illuminating antennas pointed at the target and centered in the receive antenna tracking area. The range tracking circuit uses the time delay between the transmission and reception of the illuminating antenna signals. A split-gate tracker is used to provide range tracking.

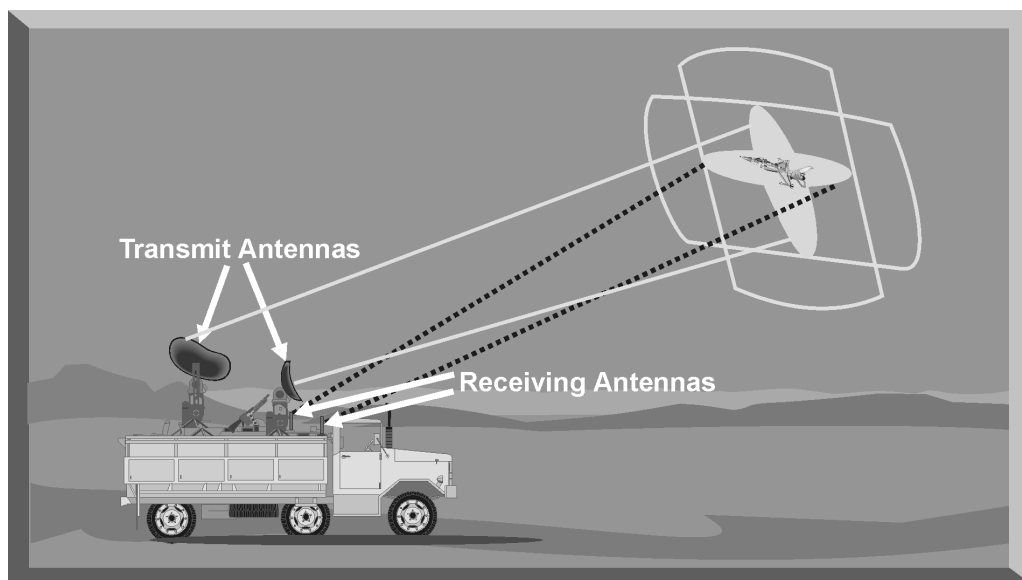

Figure 7-12. LORO Mode

a. The illuminating antennas used in the LORO mode have very narrow beamwidths and transmit at a high power level. This reduces the effectiveness of noise jamming techniques against a radar employing a LORO mode. In addition, the continuous signal from the illuminating antennas negate the effectiveness of most angle deception jamming techniques designed to defeat TWS radars. These specialized jamming techniques exploit the scan rate of TWS antennas. In the LORO mode, the illuminating antennas do not have a scan rate. The limited effectiveness of both noise and deception jamming techniques is the major advantage of the LORO mode.

b. The LORO mode also provides a track-on-jam (TOJ) capability to exploit noise jamming techniques. In a TOJ mode, the receive antennas passively track any detected noise jamming signals. The radar assumes that the most intense jamming signal is the target. The receive antennas process the strongest jamming signal as if it were a target echo from the transmit antenna signal. The receive antennas generate azimuth and elevation tracking signals to keep the jamming signal centered in the tracking area. The TOJ mode does not provide target range.

6. MONOPULSE RADAR

Monopulse radars are among the most complex radar systems. From a single pulse, a monopulse radar can derive all the data needed to update a target's position. It does this by comparing the relationship of two or more radar beams that are transmitted together from the same antenna but received separately. By comparing the phase or amplitude of the energy in these returned beams, target azimuth and elevation can be found. The speed that a monopulse radar updates the target's position, coupled with its azimuth/elevation accuracy and resistance to jamming, make this a popular choice amongst many newer TTRs.

a. The Magic T circuit allows monopulse radars to gather and process information from a single pulse that is transmitted and received using separate antennas. Figure 7-13 depicts a four-beam monopulse radar system. The Magic T is a sophisticated wave guide that can separate multiple signals by their phase relationships. This allows the radar tracking computer to compare the signal amplitude from the reflected pulses in several distinct ways. As the reflected energy enters the Magic T, it is separated by phase. The energy in the "H" arm will be in-phase and will exit from ports 1 and 2. The received energies entering the wave guide in the "E" arm exit at the number 1 port. This energy is exactly 180° out-of-phase with energy entering the H arm. This ensures there is no transfer of energy between the E and H plane arms. A typical monopulse radar would have eight Magic T's.

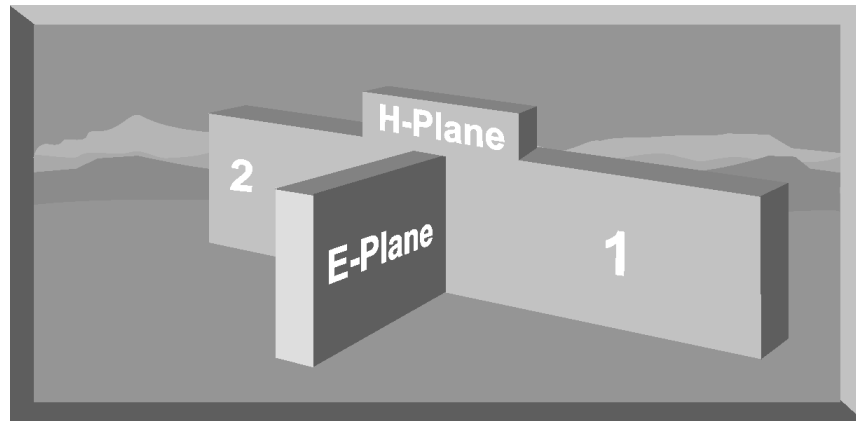

Figure 7-13. Monopulse Magic T

b. The output of a Magic T is the sum and difference of the two signals. These sum and difference values in amplitude or phase are used to generate azimuth and elevation error signals as well as to compute range. Monopulse radars may split the incoming signal as depicted in Figure 7-14. Upper antennas receive the A and B signals. Lower antennas receive the C and D signals. The various combinations of signals are processed and compared by simple addition and subtraction of the signal characteristics. From these steps, azimuth, range and elevation data are computed.

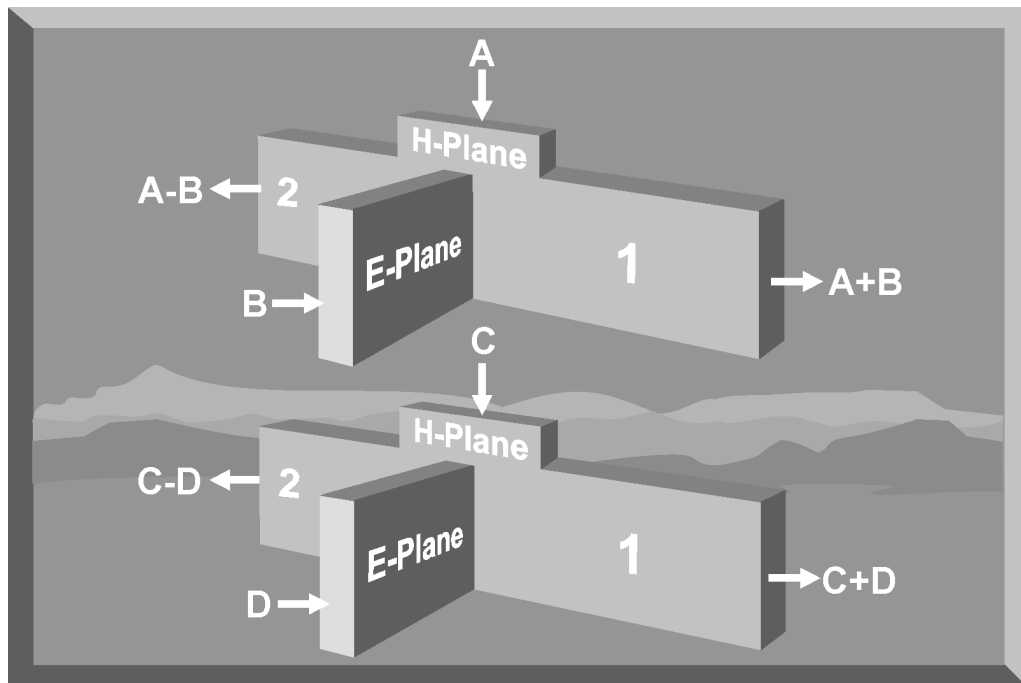

Figure 7-14. Magic T Output Signals

(1) The top equation in Figure 7-15 is used to compute target range. Target range is derived by adding the signal from the A scan to the signal from the B scan. This value is then added to the sum of the C and D scan signals. The output of these combinations is then passed to the range circuit which figures out the range of the target and displays it to the operator. Monopulse range tracking is accomplished by using either a leading-edge or split-gate tracking loop.

(2) Target elevation tracking error is derived using the middle equation from Figure 7-15. The signal from the A scan is added to the signal from the B scan. The signals from the C and D scans are also added. This time, however, the sum of A+B is subtracted from the sum of C+D. This value is then passed to the elevation circuit. Elevation signals are sent to the operator display and the servo mechanism, which corrects to the updated position of the target.

(3) The bottom equation from Figure 7-15 is used to compute the azimuth error. The signal from the A scan is added to the signal from the C scan. The B and D scans are also added together. The sums of these values are subtracted from each other. This difference equals the tracking error in azimuth. The radar system will then position the search beam to even the energy level between the two pairs of sums. When this occurs, the azimuth tracking error is zero.

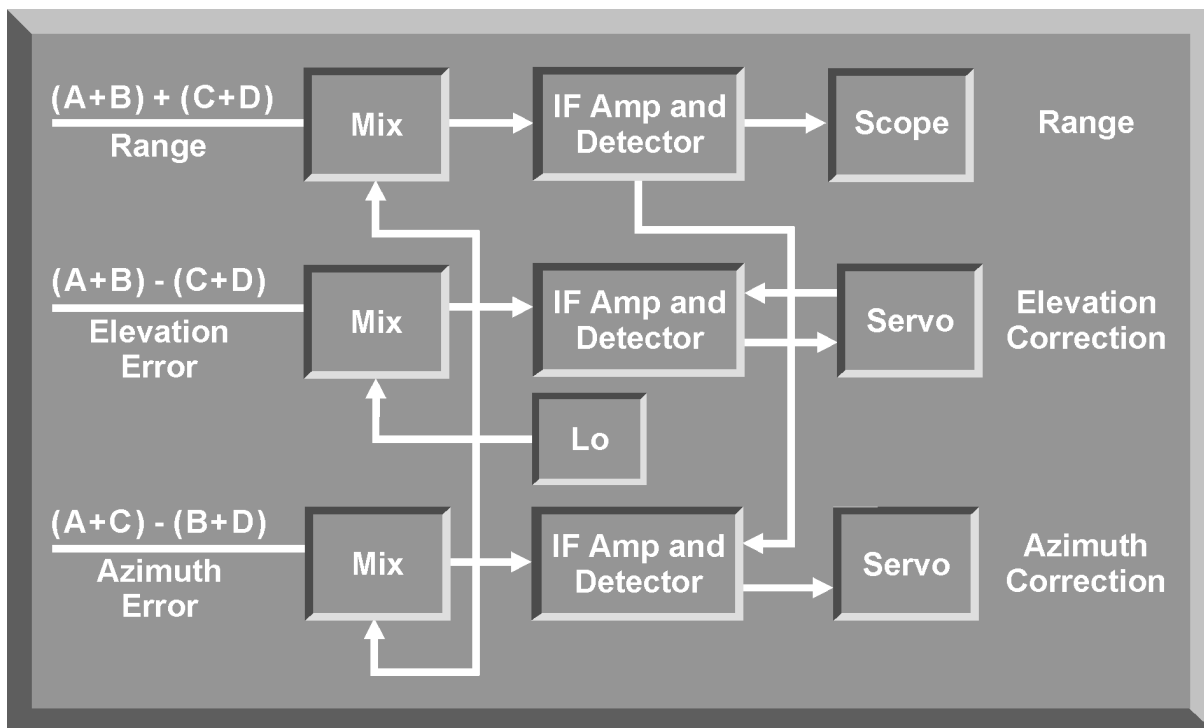

Figure 7-15. Monopulse Tracking Loops

c. A further illustration of the idea of signal combinations can be seen by referring to the F-16 in Figure 7-16. All the energy is received in the B scan area.

The A scan signal is added to the B scan signal. The signals from the C and D scans are also added. However, the sum of A+B is now subtracted from the sum of C+D. In this case, the values from the A scan and the C scan are zero. This total value of $(A+B) - (C+D)$ is then passed to the elevation circuit.

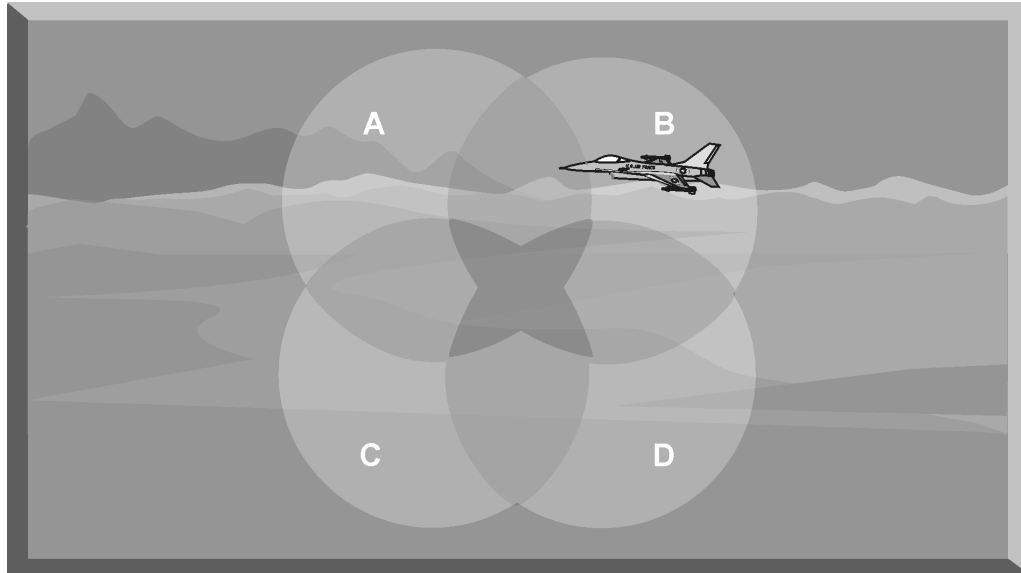

Figure 7-16. Monopulse Elevation Tracking Error

(1) The comparison in Figure 7-17 shows that all the energy is in the B scan. The radar will reposition the scan vertically to balance the energy between the B and D scans. When the energy level is balanced, the elevation error is zero.

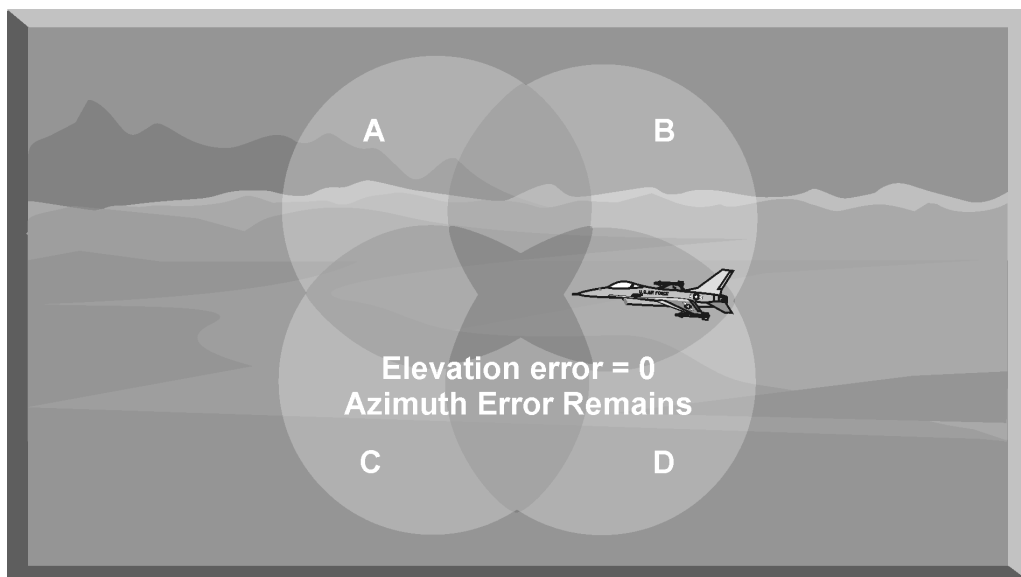

Figure 7-17. Monopulse Elevation Track

(2) Using the azimuth error equation from Figure 7-15, the azimuth tracking loop computes the azimuth error and repositions the antenna to equalize the received energy in all the beams. The monopulse radar has now established a tracking solution (Figure 7-18). All these computations are done instantaneously on a pulse-to-pulse basis.

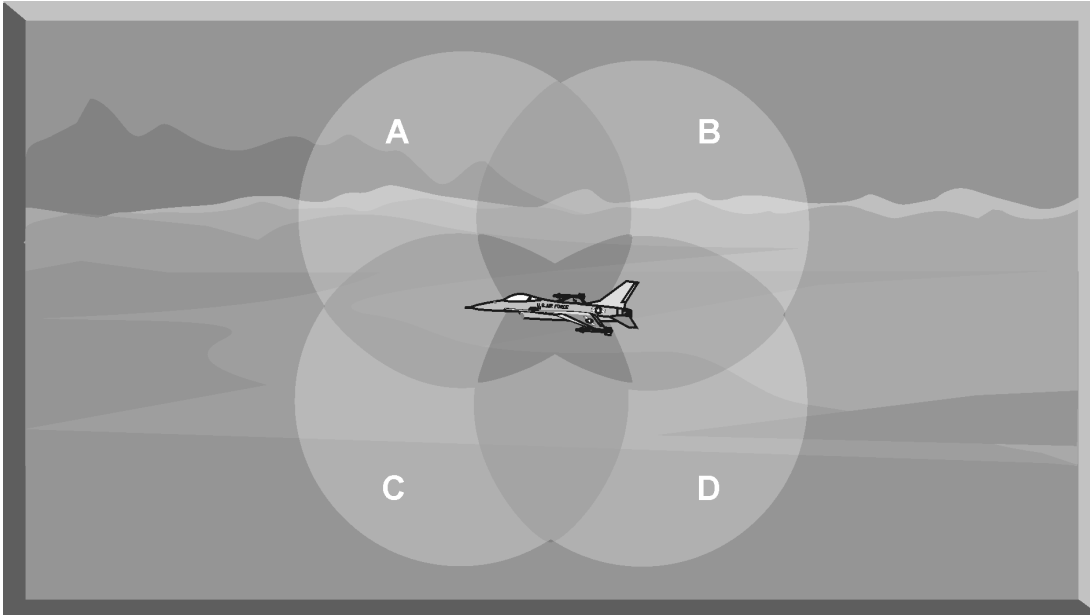

Figure 7-18. Monopulse Azimuth Track

7. CONTINUOUS WAVE (CW) RADARS

CW radar was one of the earliest forms of radar systems. Unlike pulse radar systems, CW radars emit a continuous beam of RF energy with no interruptions in the transmissions to detect returning echoes. A continuous radar transmission from the antenna requires that a classic CW radar have two antennas, one for transmission and one for reception (Figure 7-19).

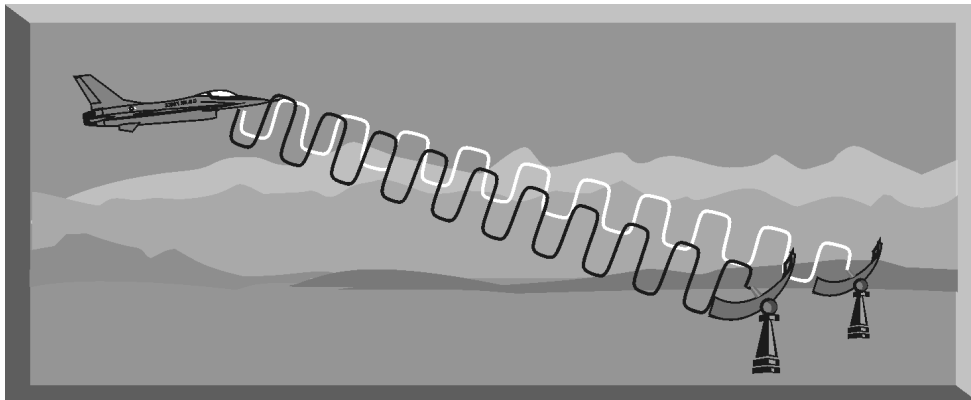

Figure 7-19. CW Radar

a. Since a continuous transmission results in a continuous echo signal, it is impossible to tell what part of the echo is associated with any particular part of the transmission. This makes range typical determination impossible. The azimuth and elevation tracking capability of a CW radar is based on the antenna position when the target is illuminated. The simple application of the Doppler principle provides a means for a CW radar to track a target in velocity and reject clutter. The Doppler principle deals with the fact that a radar return from a moving target will be shifted in frequency by an amount proportional to its radial velocity compared with the radar site. Using the difference in frequency from the transmitted signal to the received signal, a CW radar can separate the target return from clutter based on a change in frequency. This type of radar is called a CW Doppler radar.

b. The most serious disadvantage of a simple CW Doppler radar is that it does not provide any range information on the target. One method of obtaining range information from a CW radar uses frequency modulation (FM). The modulation can be sinusoidal, sawtooth, triangular, or any shape, as long as the rate of frequency change is known. The transmitter emits a continuous signal, but the frequency is changed in a known pattern. When the echo returns from the target, it is then compared to the frequency being transmitted. This frequency difference is directly proportional to the range of the target.

(1) Figure 7-20 shows how a FM CW radar measures range. Using a triangular wave for modulation, a plot of transmitted frequency over time would look like the solid line. It is important to note that this is not a depiction of the transmitted wave but a plot of how the frequency of the wave varies with time. For a target, without any relative motion, the frequency returning to the receiver is depicted by the dotted line. The target echo frequency lags the transmitted frequency by time (t). There is also a frequency difference between the transmitted and received signals. Range to the target may be computed by measuring this frequency difference and dividing by the rate of change of the transmitted frequency. The result is time. Dividing this time by 12.4 microseconds per radar mile yields range to the target. The frequency difference is constant for a target, without any relative motion, except for the brief intervals when the change in frequency goes from a positive to a negative slope. These “ditches” are negligible and can be disregarded when calculating range. The average amplitude is equal to target range.

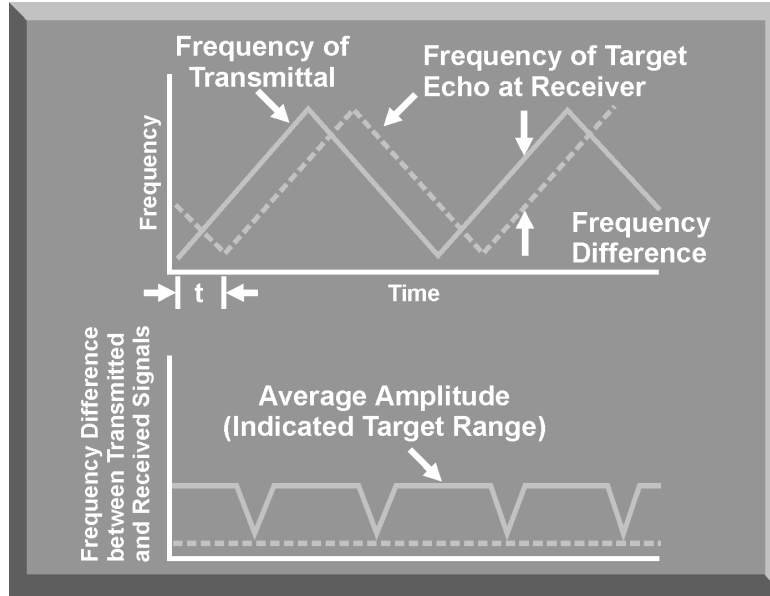

Figure 7-20. FM CW Radar Range Determination (No Relative Motion)

(2) For a target moving toward the radar, the FM CW radar measures both target range and velocity. In Figure 7-21, the frequency of the return signal will be increased as depicted by the dotted line. Remember, this is a graph of frequency versus time, not a depiction of the radar wave. For a moving target, this results in a varying frequency difference. A plot of the frequency difference over time provides target range by averaging the difference, while target velocity is found by comparing the two frequency differences.

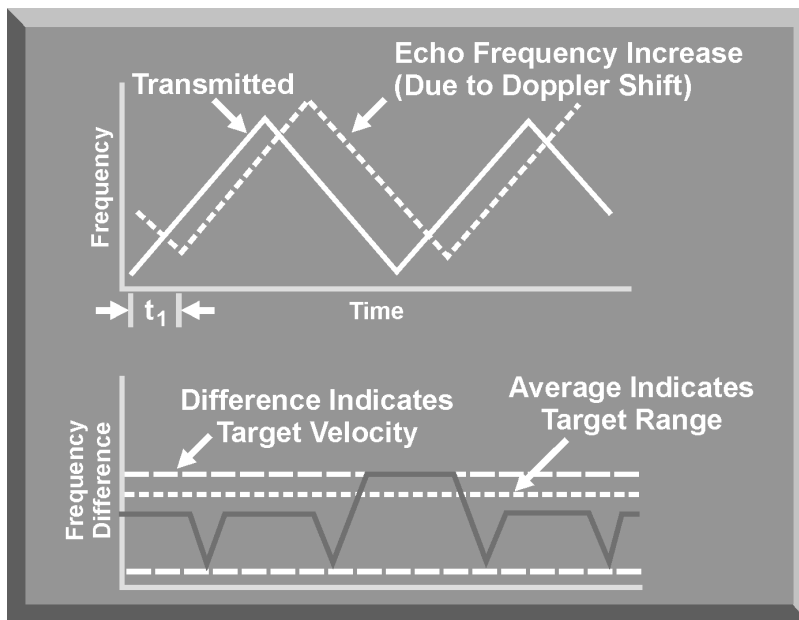

Figure 7-21. FM CW Radar Range Determination (Relative Motion)

c. The primary advantage of the FM CW Doppler radar is its ability to combine the clutter rejection features of a simple CW Doppler radar with the capability to detect range. The widest application of FM CW Doppler radars is in radar altimeters for aircraft. In addition, the HAWK missile system uses an FM CW Doppler acquisition radar and a CW target illuminator.

d. Another method used for clutter rejection in a pulse radar system is to employ special circuits, or Doppler processing, to identify and reject clutter. These special circuits are added to the receiver section of a pulse radar and are called moving target indicators (MTIs). There are two types of MTIs, non-coherent and coherent.

(1) The earliest form of MTI was called non-coherent MTI or “area” MTI. Non-coherent MTI radars do not process Doppler frequencies. The returns from one scan are subtracted from returns from the next scan. All targets that move at least one resolution cell in the time between scans are displayed. All stationary objects, including fixed clutter, are cancelled and not displayed. In this type of MTI, clutter cancellation is based on the size and movement of the return. Due to changes in the clutter cross section, instabilities in radar operations, variations such as rain or clouds, and noise from the transmitter, clutter cancellation is never complete. In another form of non-coherent MTI, the radar returns from moving targets are compared to the returns from fixed targets, and the fixed targets are cancelled. These non-coherent MTIs are simple, but they do not provide the clutter rejection available from coherent MTI radars.

(2) A coherent MTI uses the fact that Doppler shifts appear to a pulse radar as phase shifts on the received target pulse. Coherent MTI uses sophisticated circuitry, including stable local oscillators (STALOs) and coherent local oscillators (COHOs) to capture and process these phase shifts. Further processing of these phase shifts yields velocities for each return. Those velocities associated with stationary targets are rejected and only moving targets are displayed. Coherent MTIs have a major problem called “blind speeds.” Blind speeds occur for all target Doppler frequencies that are the exact PRF, or any multiple of the PRF, of the radar signal. When a target is moving at a velocity that produces this Doppler frequency, its return is cancelled along with fixed returns.

(3) There are three techniques to limit “blind speeds.” The first technique is to use a PRF stagger. By staggering the PRF, the blind speed associated with one PRF will be covered by the other PRF. The second method is called the delay line and canceler. This involves delaying each pulse so it can be compared to the next pulse before processing. This method enhances Doppler frequency comparison and rejects clutter more effectively. The third way is to use range gates and Doppler filters. A range gate is simply a switch that opens for a time corresponding to the time a radar return would arrive for a target at a specific range. For example, a range gate for all targets between 10 and 11 nautical miles would open 124 microseconds after the transmitted pulse (12.4 microseconds per mile) and close 12.4 microseconds later. A target return at this range would trip

this gate and be processed by Doppler filters to find velocity. Fixed targets would trip the range gate and be eliminated by the Doppler filters. This is a sophisticated technique that is also used by pulse Doppler radars.

8. PULSE DOPPLER RADAR

Pulse Doppler radars combine the advantages of both pulse and Doppler radar systems. Because the signal is pulsed, the radar can find range, azimuth, and elevation, similar to a conventional pulsed radar. A pulse Doppler radar can also compute overtake, or rate of closure, compared with the radar system on a pulse-to-pulse basis. A pulse Doppler radar operates much like an MTI, and the terms are sometimes used interchangeably. However, an MTI uses Doppler frequency shifts only to reject clutter while a pulse Doppler radar uses Doppler frequency shifts to reject clutter and to track targets in velocity. A pulse Doppler radar transmits a box or pulse of RF energy at the operating frequency of the radar (Figure 7-22). The frequency inside these boxes reacts the same way as the continuous waves of a CW radar, but since the RF waves are pulsed, range determination can be accomplished by measuring the time it takes for the reflected pulse to return from the target. Velocity determination and tracking are accomplished by capturing and quantifying the Doppler shift of the frequencies in each pulse.

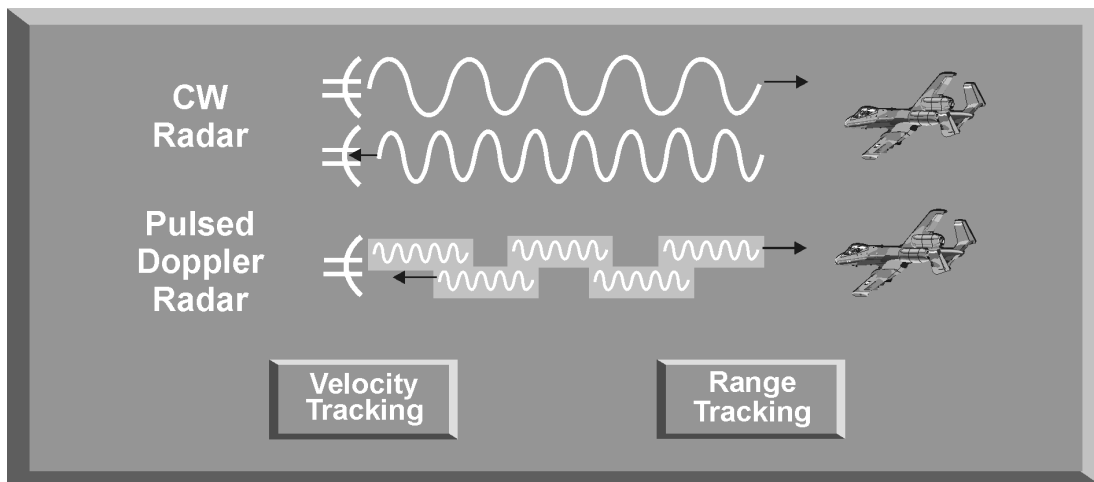

Figure 7-22. Comparison of CW Radar and Pulse Doppler Radar

a. A pulse Doppler radar tracks a single target in azimuth and elevation by employing either conical scan (sequential lobing) or monopulse tracking. Angle and elevation tracking employing these techniques is covered in Sections 3 and 6 of this chapter. The error signals generated by these techniques are sent to the antenna servos to keep the target return centered in the antenna beam.

b. Range tracking of a single target in a pulse Doppler radar is normally accomplished by a split-gate or leading-edge range tracking loop. Some pulse

Doppler radars employ an FM technique to provide range information during high PRF operations.

c. For velocity tracking, each range gate has a complete set of Doppler filter banks as depicted in Figure 7-23. Each pulse of RF energy is composed of many frequencies. To separate the returning target frequency from all other frequencies in the returning waveform, the pulse Doppler radar employs filters to cancel the unwanted frequencies. In addition, it cancels out all returns with no frequency shift, which equates to canceling all returns with no movement relative to the radar.

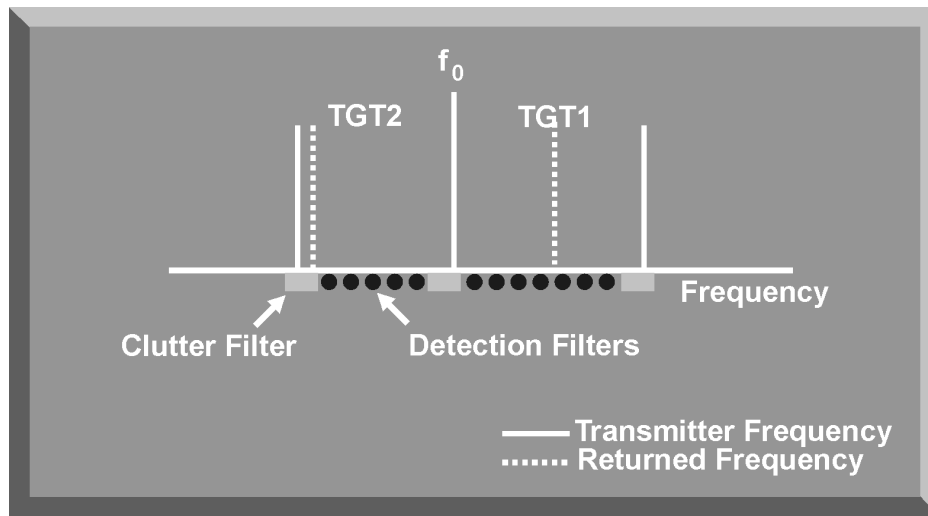

Figure 7-23. Range Ambiguity

d. The ability of a pulse Doppler radar to accomplish range, azimuth, and velocity tracking is dependent on the PRF of the radar. Table 7-1 summarizes these capabilities based on PRF. Low PRF tracking in velocity is extremely difficult due to the spacing of the spectral lines. Low PRF gives accurate range and azimuth as well as long, unambiguous range. Medium PRF tracking in range, azimuth, and velocity is easy for the radar to handle. High PRF provides excellent velocity resolution, but range ambiguities become a problem.

Table 7-1. Pulse Doppler Tracking Capabilities

Prefix	Velocity	Range	Azimuth
Low PRF	Poor	Good	Good
Med PRF	Good	Good	Good
High PRF	Excellent	Poor	Good

e. Weaknesses of pulse Doppler radars include velocity blind speeds, range ambiguity, and range eclipsing.

(1) The primary operator exploitable weakness of a pulse Doppler radar takes advantage of the pulse Doppler radar's biggest strength. The pulse Doppler is designed to eliminate ground returns so that the attacker is able to track an aircraft that used to be able to hide in ground clutter. To remove the ground clutter and avoid tracking unwanted targets like cars on a road, a filter is designed in the radar to eliminate all targets with a low velocity relative to the radar. The key to breaking track of a pulse Doppler radar is to place the aircraft in a speed less than the speed gate relative to the radar (Figure 7-24), commonly referred to as the Doppler notch.

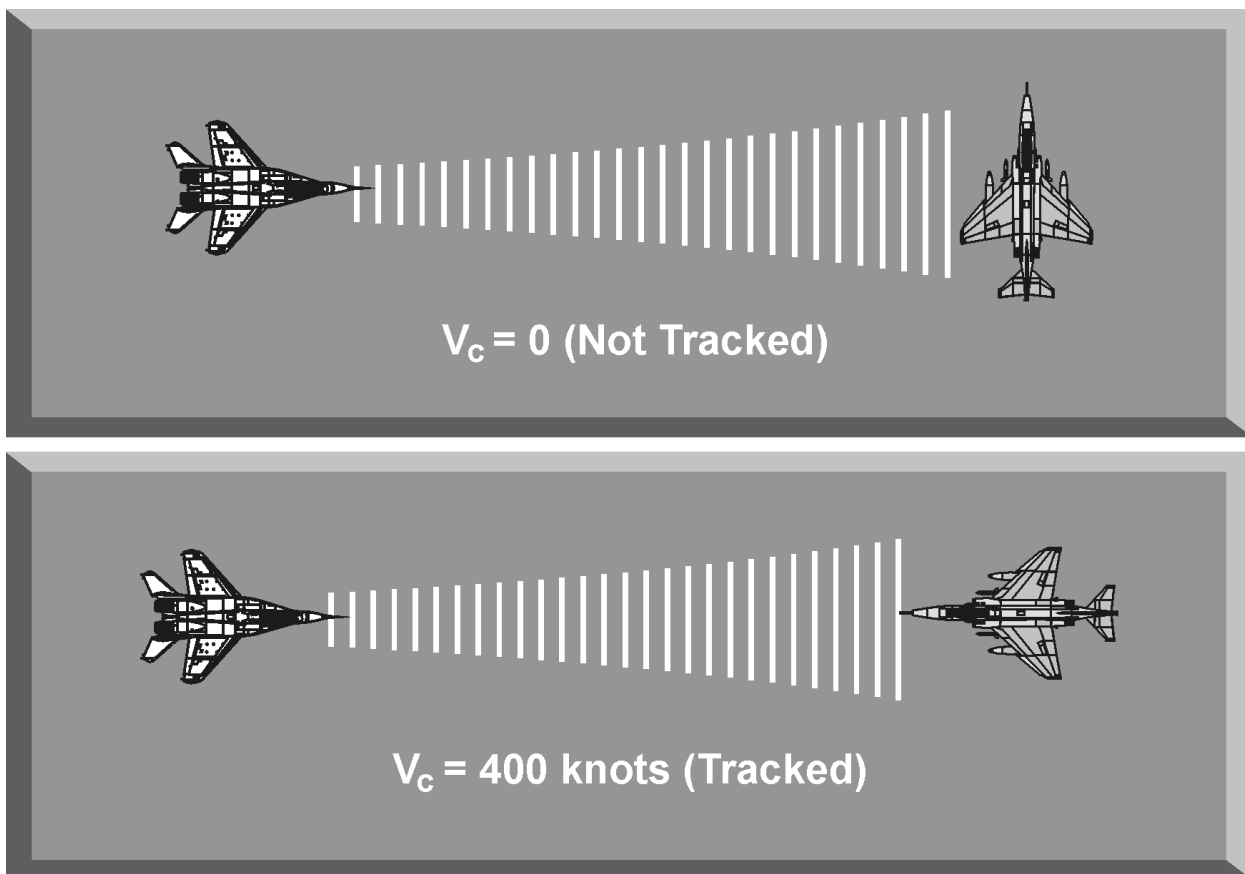

Figure 7-24. Pulse Doppler Speed Gate

(2) Range ambiguity occurs primarily with long-range targets when the return comes back to the radar after another pulse has already been transmitted (Figure 7-25). The radar will see this return and base its range calculations on the transmission time of the immediately preceding pulse, instead of the pulse that generated the return. The result will be an incorrect range calculation.

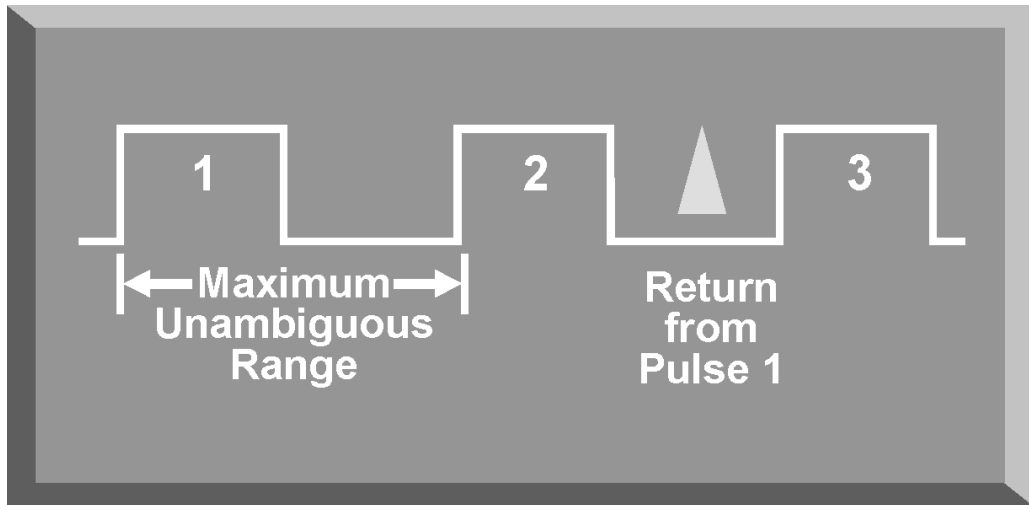

Figure 7-25. Range Ambiguity

(3) Range eclipsing occurs when a target return comes back to the radar antenna while a pulse is being transmitted (Figure 7-26). Since the radar cannot receive while transmitting, the return will not be displayed.

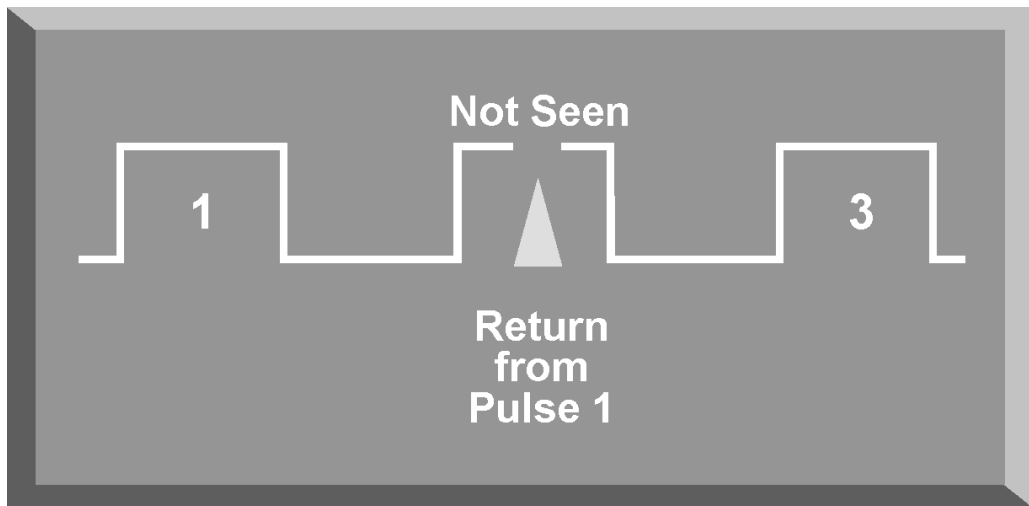

Figure 7-26. Range Eclipsing

(4) To solve the problems of range ambiguity and eclipsing, a pulse Doppler radar employs different PRFs and computer logic. In Figure 7-27, at PRF 1, the return from target 1 is eclipsed, and target 2 is ambiguous. By changing the PRF slightly, these range problems can be resolved. Notice that at PRF 2, neither target is eclipsed, and at PRF 3, target 2 is eclipsed. The computer logic needs to be extremely advanced to compensate for these problems. These simplistic examples show the complex problem of using multiple PRFs.

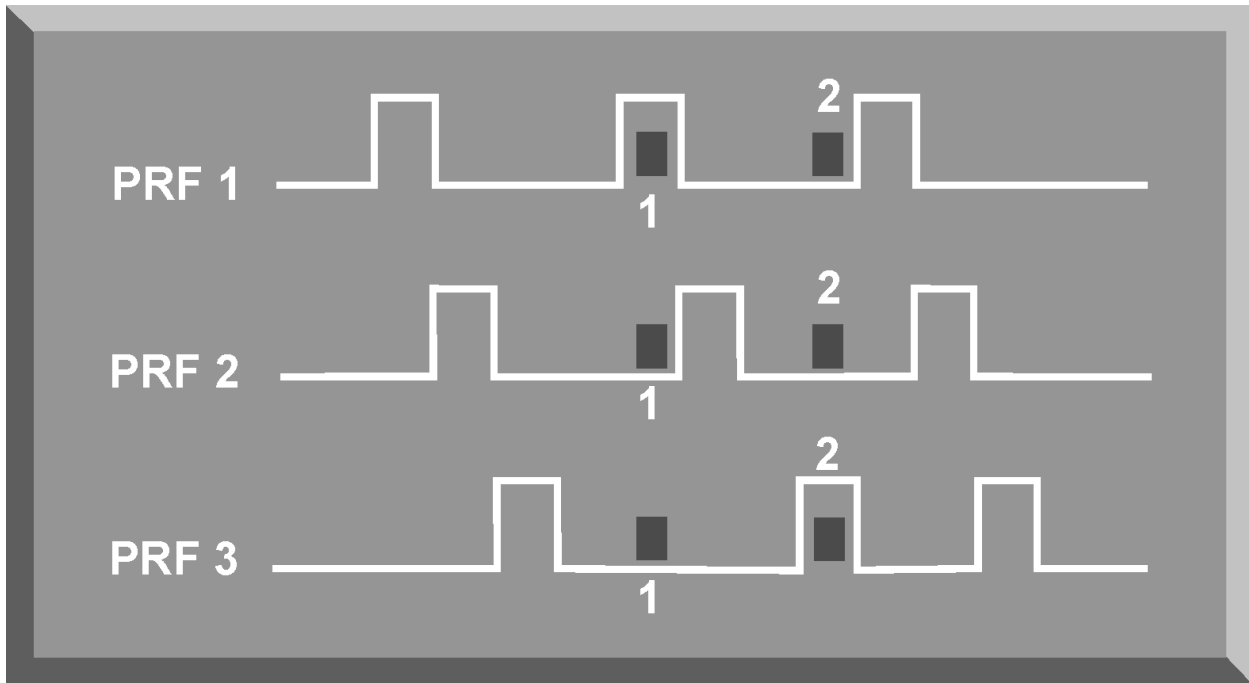

Figure 7-27. Resolving Range Ambiguity and Eclipsing

9. SUMMARY

This chapter has discussed the range, azimuth, elevation, and velocity tracking techniques employed by conical scan, TWS, LORO, monopulse, CW Doppler, and pulse Doppler radar systems. The method used by a specific radar system to track a target determines the type of jamming technique required to counter this system. A basic understanding of the target tracking techniques will enable you to understand the basic jamming techniques employed to defeat these threats.

CHAPTER 8. RADAR MISSILE GUIDANCE TECHNIQUES

1. INTRODUCTION

Once a target has been designated, acquired, and tracked by a radar system, the final stage in target engagement is to guide a missile or projectile to destroy the target. There are three basic requirements for successful missile guidance: (1) precise target tracking by a target tracking radar (TTR) to provide target parameters (range, azimuth, elevation, velocity, etc.), (2) a method to track the position of the missile compared with the target, and (3) a fire control computer to generate missile guidance commands based on target and missile position. The missile guidance techniques employed by modern air-to-air and surface-to-air missile (SAM) systems will be covered in this chapter. In addition, the target engagement techniques employed by anti-aircraft artillery (AAA) systems will also be discussed. There are three distinct phases in any missile intercept: boost, mid-course, and terminal.

a. Nearly all missiles are unguided during the initial boost phase (Figure 8-1). During the boost phase, the missile electrical and hydraulic systems are activated and are coming up to operating parameters. The missile is gathering speed and normally will be in an unguided mode of flight.



Figure 8-1. Initial Boost Phase

b. During the mid-course phase, the missile is actively being guided to the target using some type of guidance signal (Figure 8-2). Guidance signals deflect

the control vanes of the missile to change its direction. These vanes change the roll, pitch, and yaw, in some combination, to control the missile flight path. Normally a gas grain generator powers a small hydraulic pump that deflects the control vanes in response to guidance signals. Each missile carries a limited supply of hydraulic fluid for maneuvering. The fluid is expended through vents with every control surface activation. The limited quantity of hydraulic fluid can be a significant factor during a long-range missile intercept.

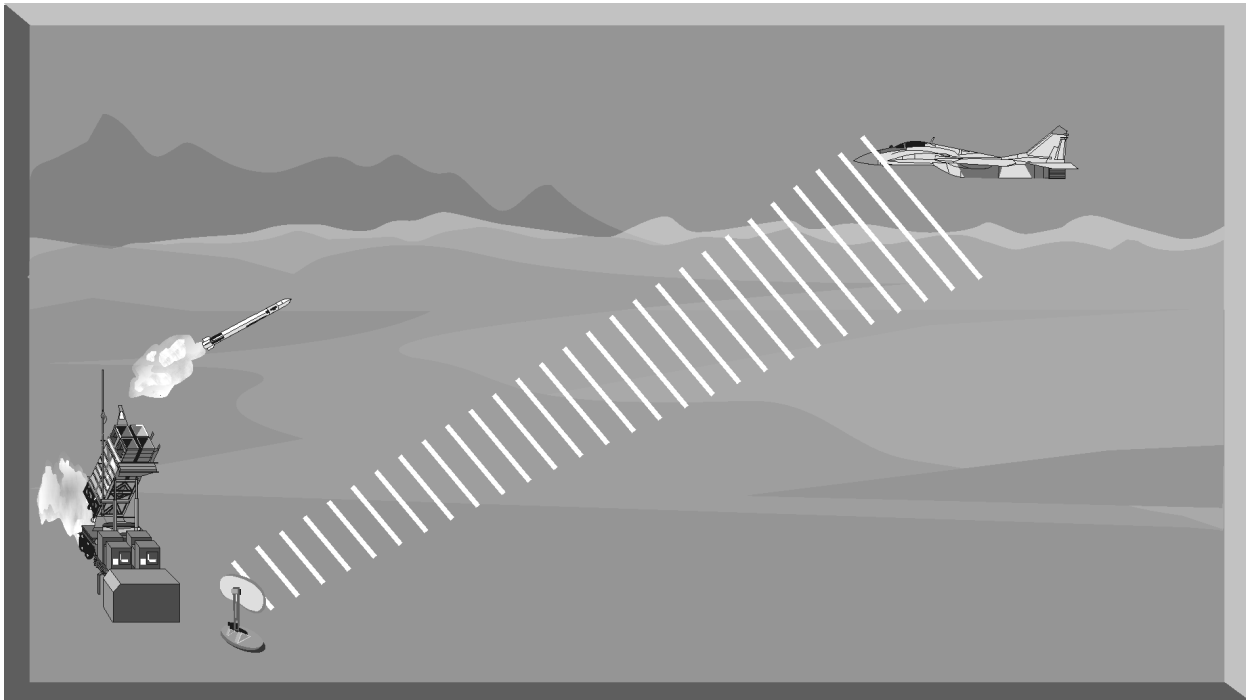

Figure 8-2. Mid-Course Guidance Phase

c. The final phase of an intercept is the terminal phase (Figure 8-3). During this phase, the missile attempts to pass close enough to the target to detonate the fuse while the target is within the lethal radius of the warhead. Modern missiles employ both a contact fuse and some type of proximity fuse. Proximity fuses range from command detonation for command-guided missiles, fractional Doppler gates for semi-active guided missiles, to active laser fuses for IR-guided missiles.

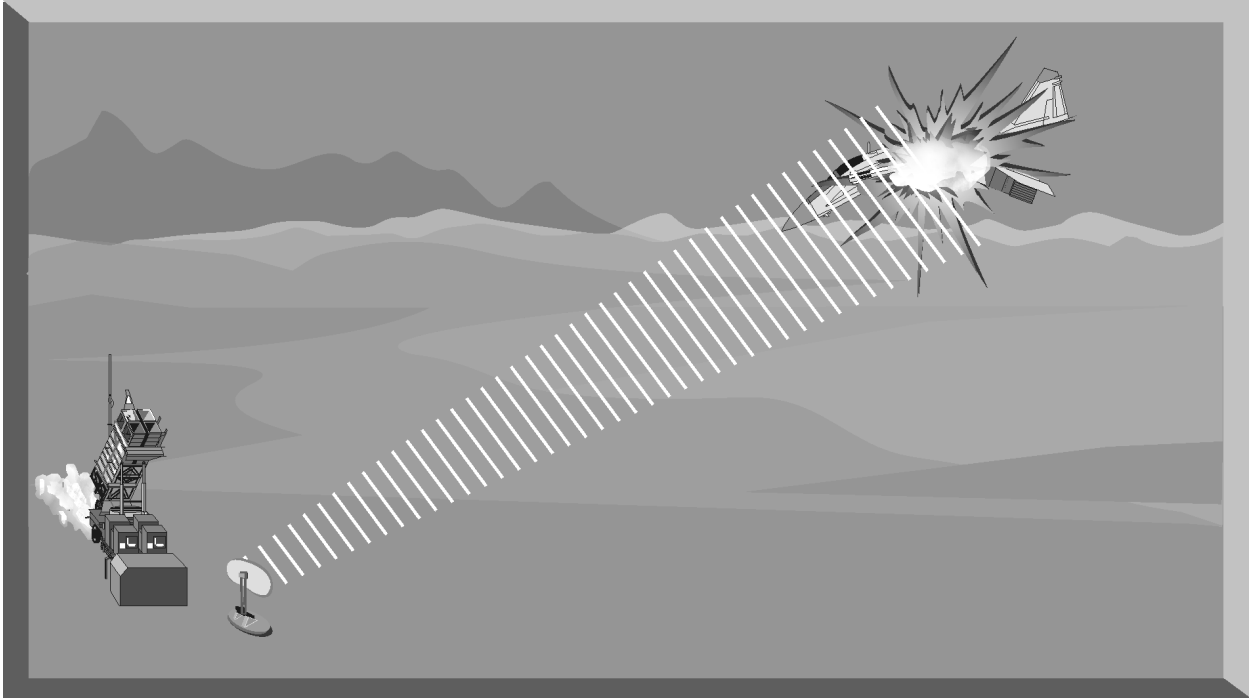

Figure 8-3. Terminal Guidance Phase

2. COMMAND GUIDANCE

Command guidance uses a fire control computer to constantly send course correction commands to the missile throughout its flight. These commands are a series of electrical missile guidance pulses called doublets or triplets. These pulses provide steering commands to the missile by varying the spacing between each guidance pulse. Each pulse, or pulse combination, relays some roll, pitch, and yaw command to the missile. These inputs are constantly corrected for the spatial relationship between the missile and the target's present position and rate of motion. Guidance commands are passed to the missile by specialized antennas on the TTR and an antenna installed on the missile, called a missile beacon. The beacon is a special radio receiver and transmitter that is attached to the rear of the missile. It acts like a transponder in that the TTR tracks and receives guidance commands. The guidance frequency may be widely separated from the target tracking radar frequency to minimize interference. This beacon is usually masked until missile booster separation. This results in the missile being launched unguided for the first 2-3 seconds. This type of delay is one of the reasons that all command-guided missile systems have a minimum launch range. Command guidance is used by the SA-2, SA-3, SA-4, and SA-8.

a. Command-guided missiles will generally fly a rectified (full or half) or three-point pursuit geometry during the mid-course portion of the intercept (Figure 8-4). However, a command-guided missile may transition to a pure pursuit geometry during the terminal phase of the intercept. Rectified geometry involves the prediction of where the target and the missile will be at some point in the future.

The target's direction and rate of movement is tracked and predicted. The missile is then launched, pulls lead on the target, and is guided to the point in the sky where the intercept is predicted to take place. This profile requires the constant update of both the target and missile positions.

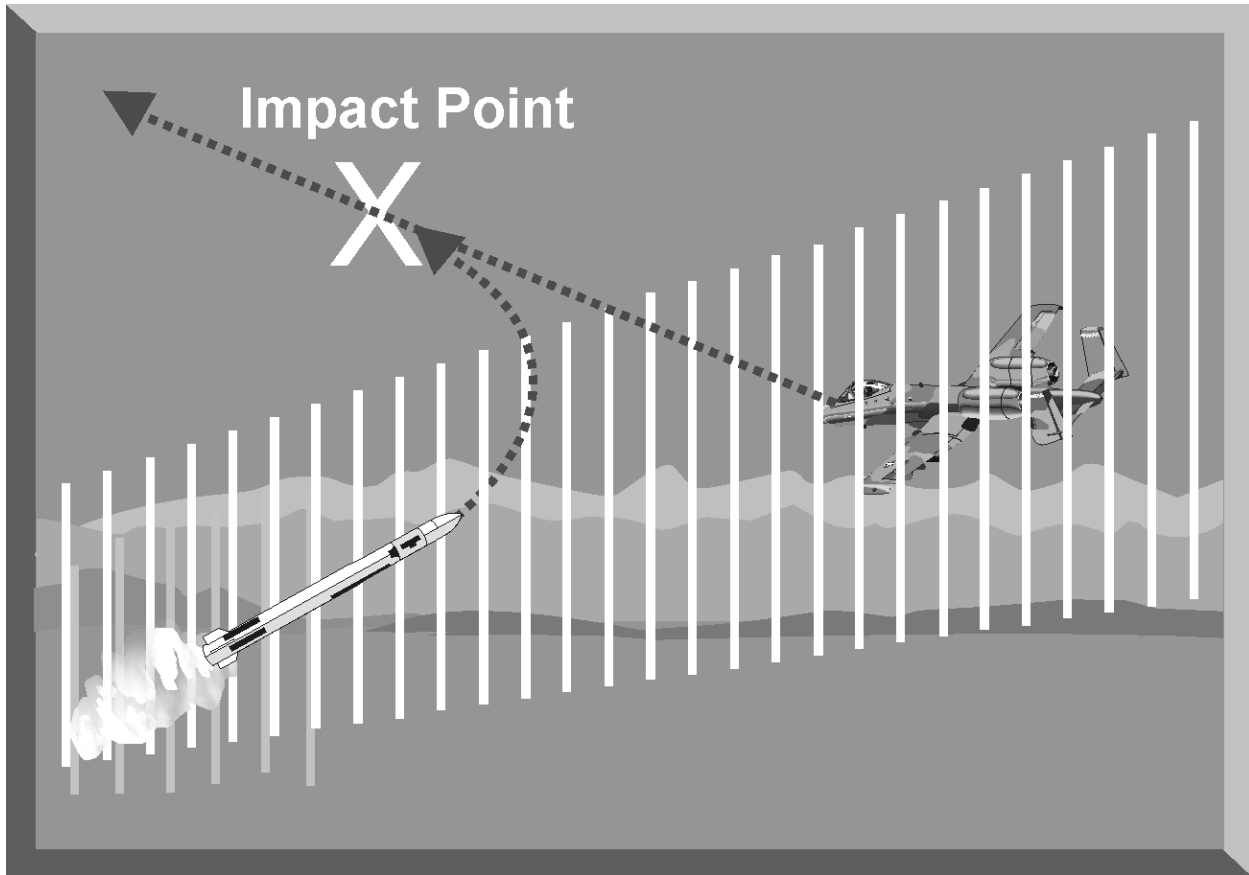

Figure 8-4. Rectified Flight Profile

b. Three-point pursuit geometry is often used when there is incomplete range tracking data on the target. In this case, it will be impossible to predict exactly where the target will be at some point in the future. In this profile, the target tracking radar constantly tracks the target. The missile location will be updated by the missile beacon. The fire control computer will direct the missile to fly directly down the tracking radar beam toward the target. In this geometry, the missile may start out on a direct intercept course and, depending on the target's direction and rate of movement, transition to a pure pursuit intercept. The three points in three-point missile geometry are depicted in Figure 8-5. Point one is the target tracking radar, point two is the missile itself, and point three is the target. By keeping all three points always in a line, the missile will intercept the target at some point, although the range of the target is unknown.

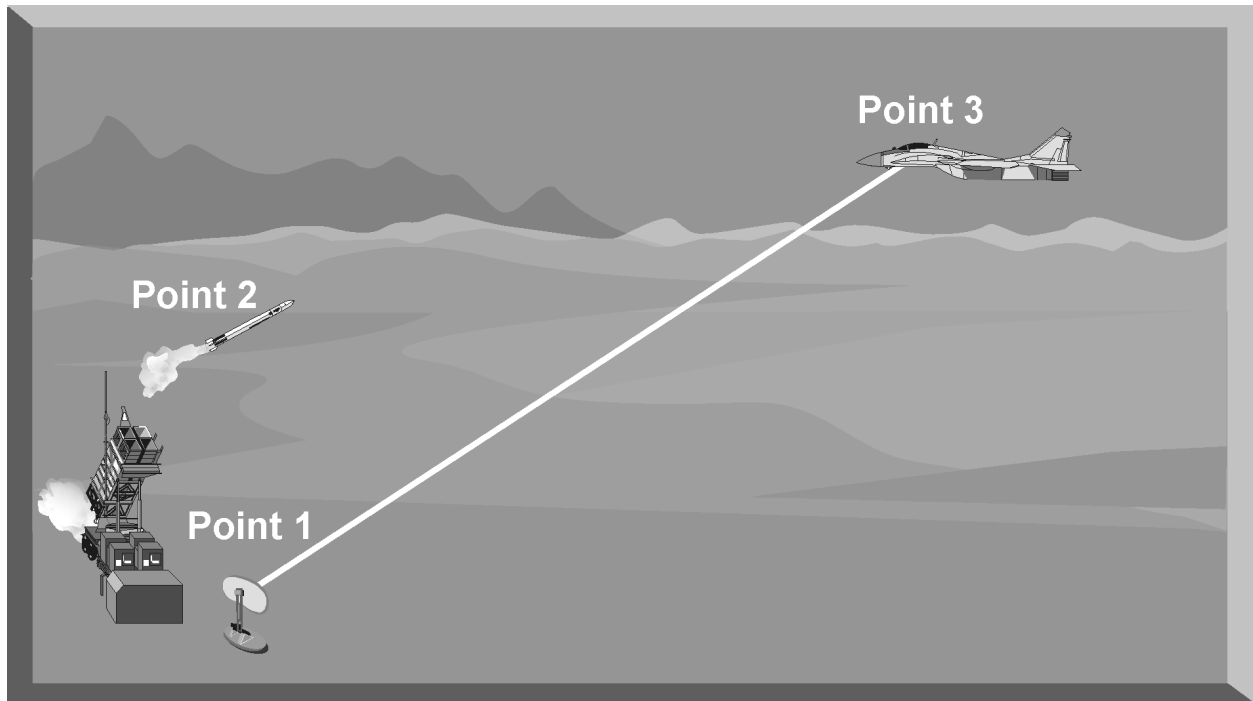

Figure 8-5. Command Guidance: Three-Point Pursuit

c. Command guidance techniques have many advantages. First, command-guided missiles can adjust their flight geometry throughout an intercept profile. Second, the missiles are uncomplicated since they do not carry onboard computers or target tracking equipment. The fire control computer associated with the TTR accomplishes all intercept calculations. Third, the primary intercept profile, a full- or half-rectified intercept, is the fastest and most fuel-efficient intercept. Fourth, command guidance is difficult to jam since the missile beacon antenna is at the rear of the missile and can be relatively high-powered. And finally, an intercept is possible even without accurate range information by using the three point intercept profile.

d. Command guidance has several disadvantages. First, the use of a missile beacon delays the capture of the missile by the tracking radar. This can cause a large dead zone which equates to a larger minimum engagement range. Second, the accuracy of the intercept geometry is only as good as the tracking information provided by the target tracking radar. Jamming, interference, or loss of signal will adversely affect the intercept accuracy. In addition, normal radar characteristics could produce sufficient errors to cause the missile to miss the target, especially at longer ranges. Third, with insufficient range information, the three-point intercept profile is very slow and could result in the missile running out of energy before it gets to the target. Fourth, command guidance is reactive. The fire control computer constantly updates the intercept geometry based on target maneuvering. This results in missile maneuvering lagging target maneuvers.

3. SEMI-ACTIVE GUIDANCE

Semi-active guidance is significantly different from command guidance, but only after launch. The first requirement is still for the target tracking radar to maintain a solid target track, with the tracking data being supplied to the fire control computer. The fire control computer then directs a target illumination antenna to point at the target and illuminates it with CW energy. The missile then passively homes on the reflected CW energy.

a. The missile used by a threat system that uses CW homing is vastly different from the missile being guided by a command guidance signal. The missile that homes on CW energy must be equipped with a seeker section composed of an antenna and an internal receiver. The seeker section processes and computes the necessary course corrections as it flies toward the target. It can do this by knowing the zero boresight line of the antenna within the missile (Figure 8-6). As the reflected CW energy is received by the seeker, there is normally some deviation from the zero reference position. The onboard computer then directs the control surfaces to change the flight path to reduce the reference errors in the antenna to zero, if possible. When the error between the antenna position and the boresight position is zero, the missile is pointed directly at the target.

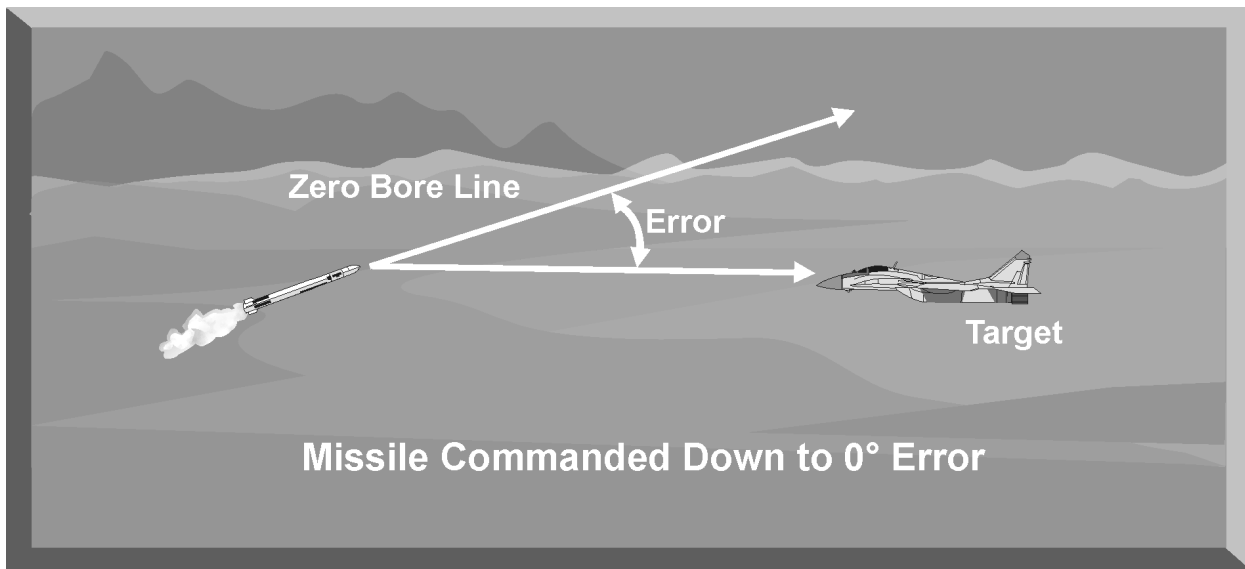

Figure 8-6. Semi-Active Guided Missile

b. Missile systems that use semi-active guidance normally use velocity as the primary target discriminator during the intercept. The missile seeker locks onto a reference Doppler signal provided by the fire control computer before launch. This Doppler signal establishes a tracking gate around the velocity of the target. After the missile is launched, it initially compares the reference Doppler to the target Doppler signal.

c. The mid-course phase for a semi-active missile is also different from that of a command-guided missile. A semi-active guided missile follows the reflected CW energy during the mid-course phase of the intercept and normally attempts to fly a lead pursuit profile to the target (Figure 8-7). If the target maneuvers, however, the missile may transition to a pure pursuit flight path. Unlike a command-guided missile, a semi-active guided missile does not use a missile beacon. The fire control computer does not need to know where the missile is to compute course corrections since all that is necessary is to illuminate the target with the CW illuminator. This also means that the missile can begin to track and guide when it is launched and locked on to the reference Doppler gate. Semi-active guidance is the primary mode of guidance for many surface-to-air missiles, and almost all radar-guided air-to-air missiles.

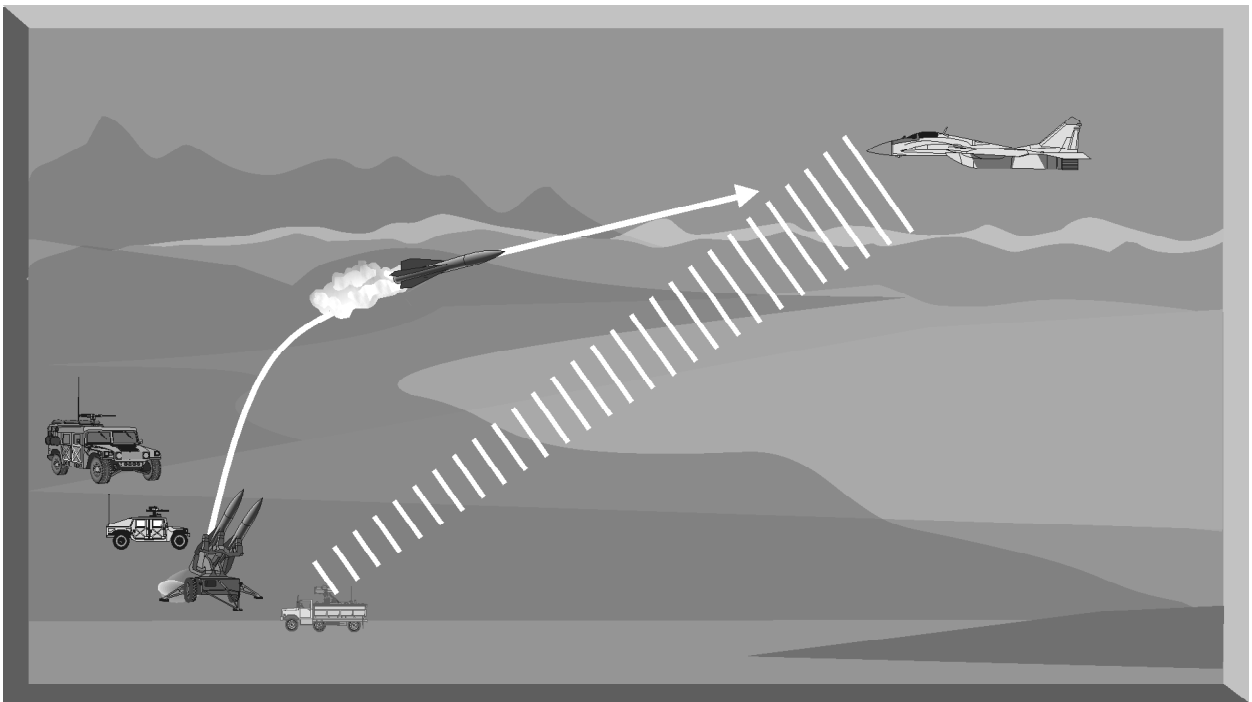

Figure 8-7. Semi-Active Guidance (Mid-Course)

d. As the missile enters the terminal phase of the intercept, there is no change in the guidance mode used by a CW homing missile. The missile may complete the terminal phase of the intercept geometry by going to a pure pursuit flight path, if necessary (Figure 8-8). The missile continues to home in on the reflected CW signal until it passes close enough for the fuse to function.

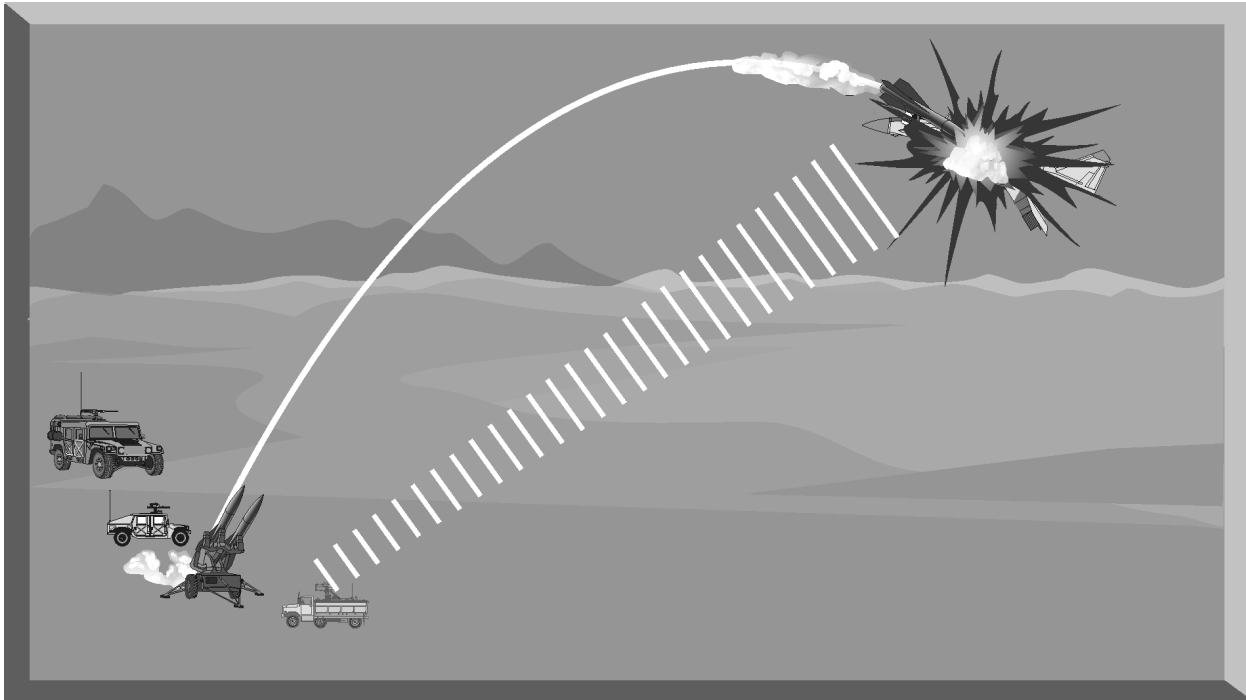

Figure 8-8. Semi-Active Guidance (Terminal Phase)

e. Semi-active missile guidance has many advantages. First, a semi-active guided missile is resistant to electronic jamming that may be used to deny range information. Second, a semi-active missile can be guided almost immediately after launch. This gives it a very small minimum range since it can maneuver almost as soon as it clears the launch rail. Third, it computes its own course corrections as necessary. This allows for a much quicker reaction to target maneuvers compared to a command-guided missile. Fourth, during a long-range intercept, a CW missile can be more accurate than a command-guided missile. This is accomplished by taking the inherent long-range radar tracking errors out of the equation. The target tracking radar only has to keep the target illuminated so that it can point the CW antenna at the target.

f. Although semi-active missile guidance is generally considered an excellent guidance technique, it does have some disadvantages. First, a semi-active guided missile normally requires reference Doppler values to be entered into the missile computer before launch. Without this reference, a semi-active missile cannot be launched (Figure 8-9). Second, a semi-active homing missile must maintain a lock onto the target Doppler. The use of chaff and beam maneuvers, which result in a near zero target Doppler, may cause a missile or radar to break lock. Third, if a break-lock occurs, a CW homing missile normally cannot regain target track and complete the intercept.

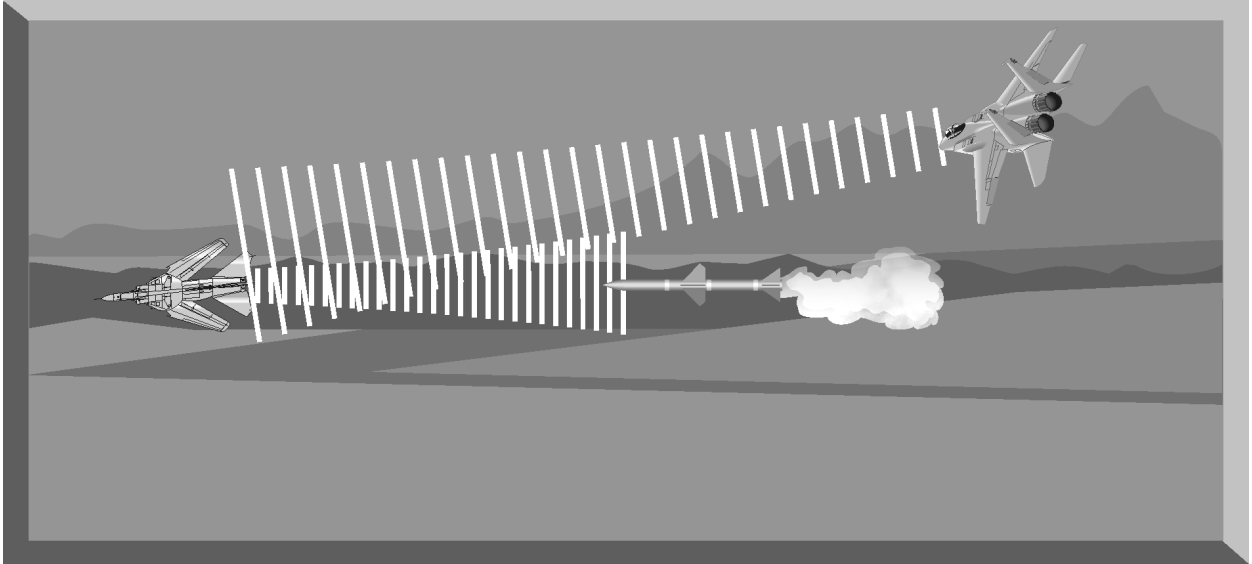

Figure 8-9. Semi-Active Guidance CW Reference Signal

4. ACTIVE GUIDANCE

Active guidance is an improvement that has been included in several new long-range missiles such as the AIM-54 Phoenix and the AIM-120 AMRAAM. This specialized guidance mode is only active during the terminal phase of flight. The mid-course phase usually employs semi-active or command guidance (Figure 8-10).

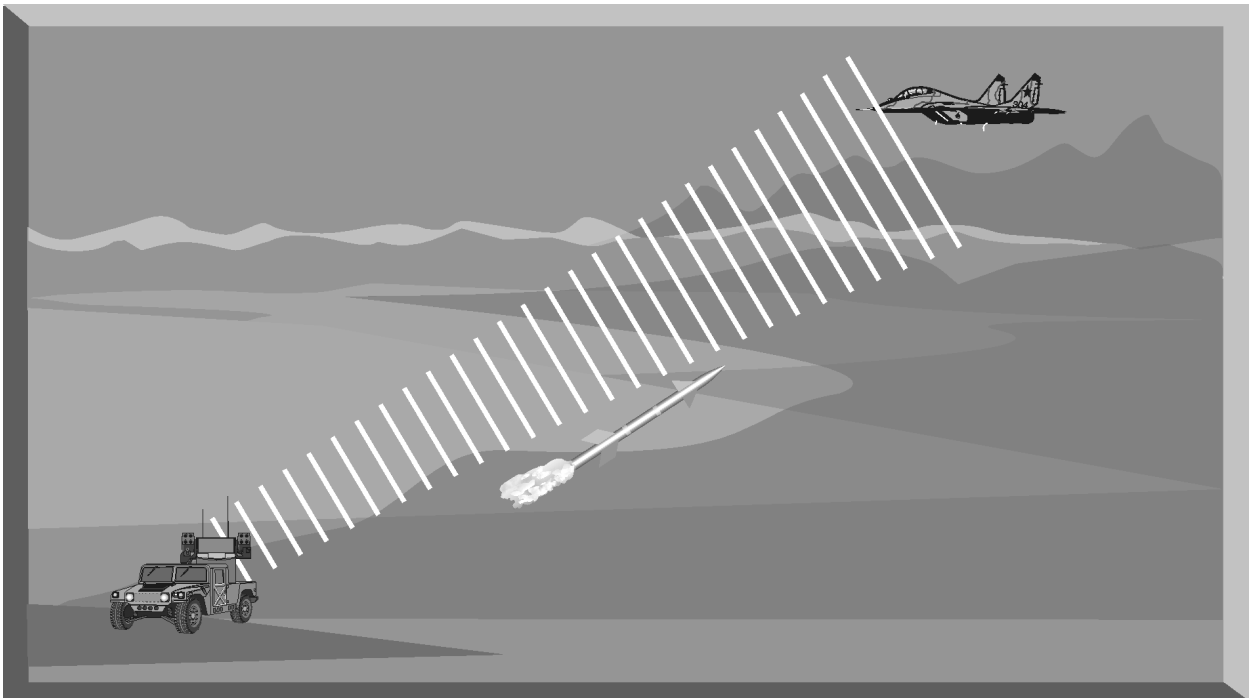

Figure 8-10. Active Guidance Mid-Course Intercept Phase

a. The range at which the missile goes “active” is dependent on the intercept geometry. High-aspect angle intercepts allow the activation of active guidance sooner than beam or tail-aspect intercepts. Missiles that employ active guidance carry a complete miniature radar system and fire control computer within the missile. As the missile nears the target, its internal radar system turns on and locks onto the target. The internal fire control computer directs control inputs to complete the intercept (Figure 8-11).

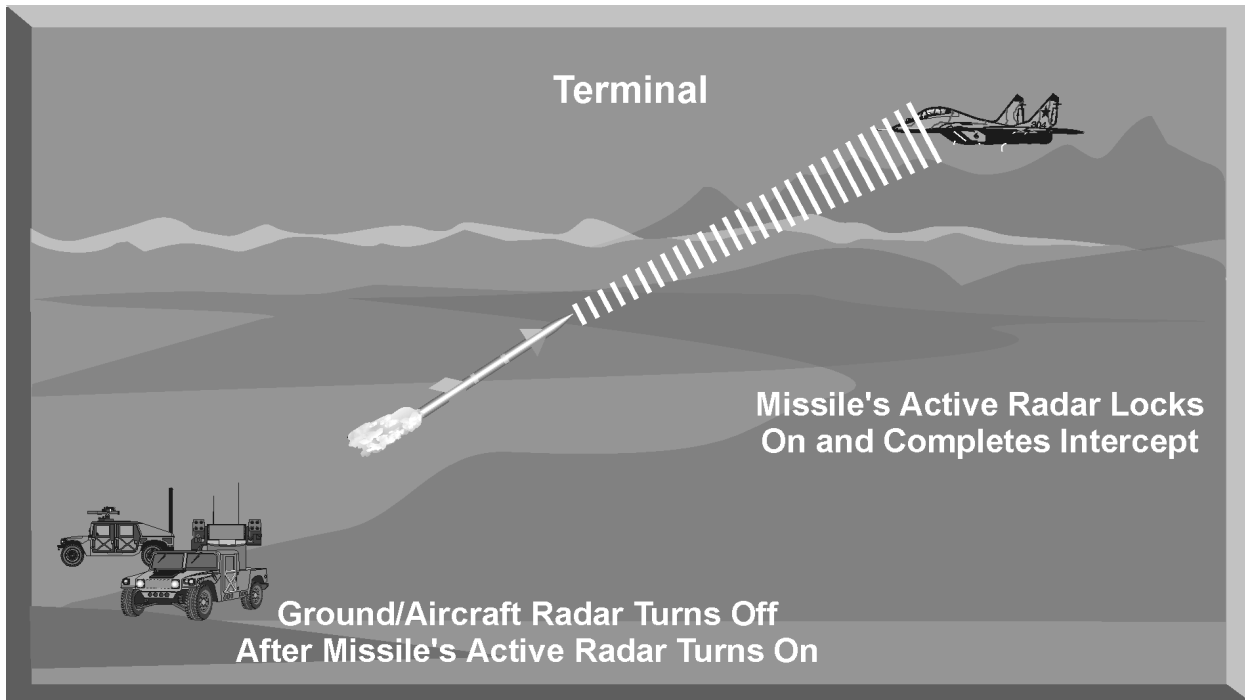

Figure 8-11. Active Guidance Phase

b. Active-guided missiles have many advantages. First, active-guided missiles are very accurate at long ranges. This is because they do not rely on the target tracking radar once their internal radar takes over the intercept. Second, an active missile is extremely difficult to jam. It uses a narrow beam and its relative power is constantly increasing as it nears the target. Third, an active-guided missile is a fire-and-forget weapon. Command or semi-active missile guidance requires the target tracking radar to maintain lock-on until the intercept is completed. In an air-to-air engagement, this means the interceptor is predictable until the missile hits the target, and vulnerable to an enemy missile attack. An interceptor with an active missile, however, may launch the missile and, once it goes “active,” can then turn around or maneuver defensively.

c. Active-guided missiles have a few disadvantages as well. First, the active homing missile is a complex missile integrating both command and active guidance modes. Second, the missile may still be susceptible to electronic jamming during the mid-course phase of flight. Remember, during the mid-course

phase, the missile relies on command or semi-active guidance. Jamming the target tracking radar may affect the missile's ability to “see” the target near the terminal phase.

5. SEEKER-AIDED GROUND GUIDANCE/TRACK-VIA-MISSILE GUIDANCE

In seeker-aided ground guidance (SAGG) and track-via-missile (TVM) guidance, the target is illuminated by the ground-based radar and the missile receives reflected energy from the target. Unlike conventional semi-active homing, the missile does not generate its own guidance commands. Instead, the missile transmits raw engagement data to the ground-based fire control system (FCS) in order to generate uplink guidance commands. TVM is similar to SAGG; however, additional processing is done on-board the missile prior to transmitting the engagement data to the ground-based FCS.

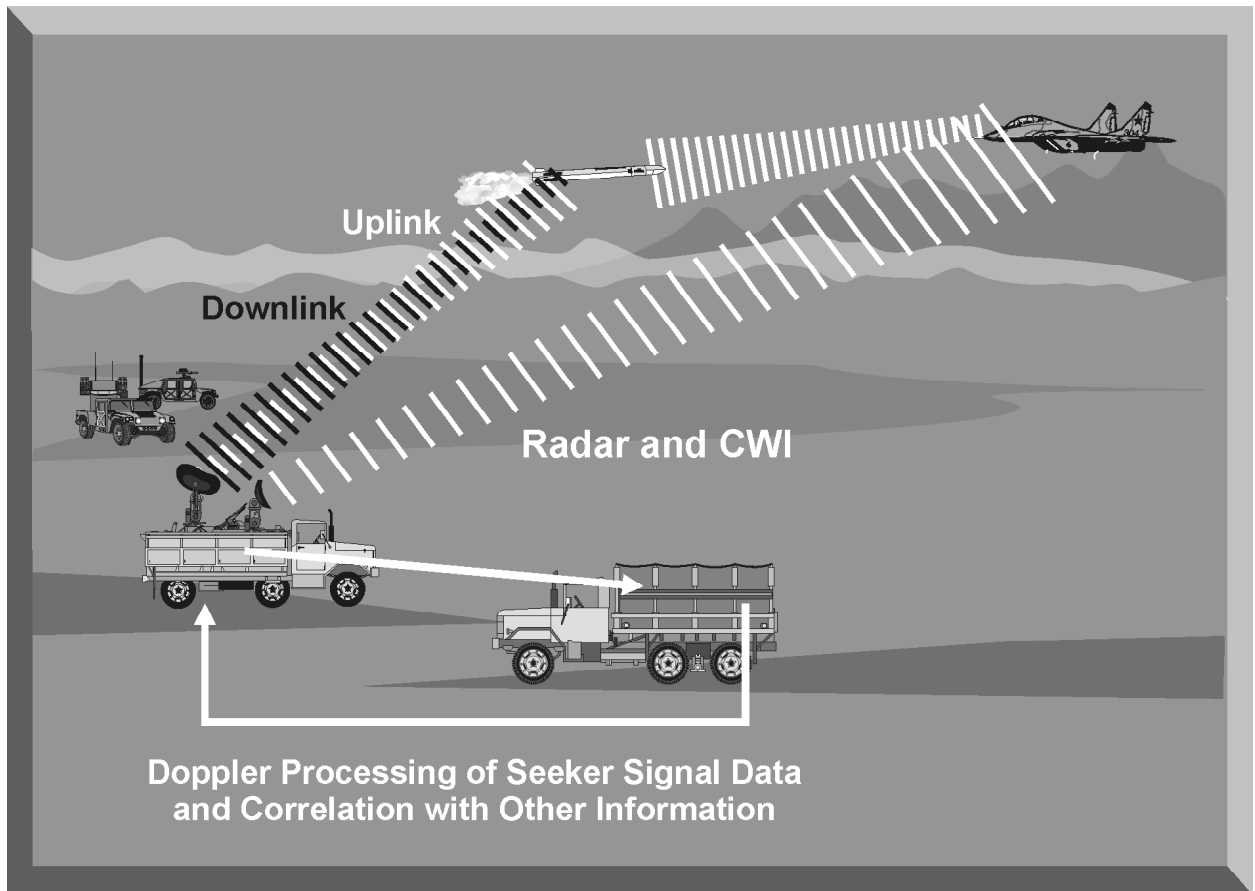

Figure 8-12. SAGG/Track-Via-Missile Guidance

a. Track-via-missile and seeker-aided ground guidance are two relatively new missile guidance techniques with similar advantages. First, they are extremely accurate at long ranges where the inherent radar tracking errors may be large

enough to cause a miss. Second, they can respond very quickly to any actions taken by the target since the missile seeker can track these changes and transmit the new position to the TTR fire control computer. Third, TVM and SAGG can be used with a large and capable fire control computer since most computations are accomplished by the TTR. Fourth, the integration of a phased array radar and the powerful TTR fire control computer allows the missile system to engage multiple targets. The Patriot missile battery, for example, can track and engage at least four targets simultaneously.

b. The major disadvantage of track-via-missile and seeker-aided ground guidance is that they are the most complex forms of missile guidance. They require the use of sophisticated computers to combine radar tracking data and data received from the missile. This required hardware is expensive and demands greater maintenance and logistical support. In addition, the missile itself needs to be large enough to store the appropriate hardware for computations and data transfer.

6. ANTI-AIRCRAFT ARTILLERY (AAA)

The classic role of AAA is point defense. AAA systems provide close-in defense for high-value targets. AAA systems are deployed to defend cities, airfields, bridges, industrial centers, lines of communications, command and control centers, infantry/tank units, and SAM sites. There are two types of AAA systems: towed and mobile. Towed AAA is normally deployed in fixed sites around key targets. Mobile AAA systems are deployed to provide air defense for army units and to protect mobile SAM sites. The effectiveness of AAA systems, towed or mobile, depends on the ability of the system to predict an aircraft's future position to fire its unguided ballistic projectile to intercept the aircraft and destroy it. To accomplish this objective, AAA systems employ two primary tactics, aimed fire and sector/barrage fire.

a. Aimed AAA fire requires very accurate aircraft position information and an accurate prediction of future position. For aimed AAA fire, this information can be derived by using an optical sighting system on the gun or by employing a radar system coupled with a fire control computer. Smaller caliber AAA guns generally rely on optical target acquisition and firing (Figure 8-13). The high rate of fire, short range, and short projectile time of flight (TOF) simplifies the prediction and aiming problem for these systems. Smaller caliber AAA can also use tracer ammunition to help the gunner in correcting his optical firing solution. Larger caliber AAA systems, with slow rates of fire, long range, and long projectile TOF, generally use a TTR and a fire control computer to solve the problems associated with aimed fire (Figure 8-14).

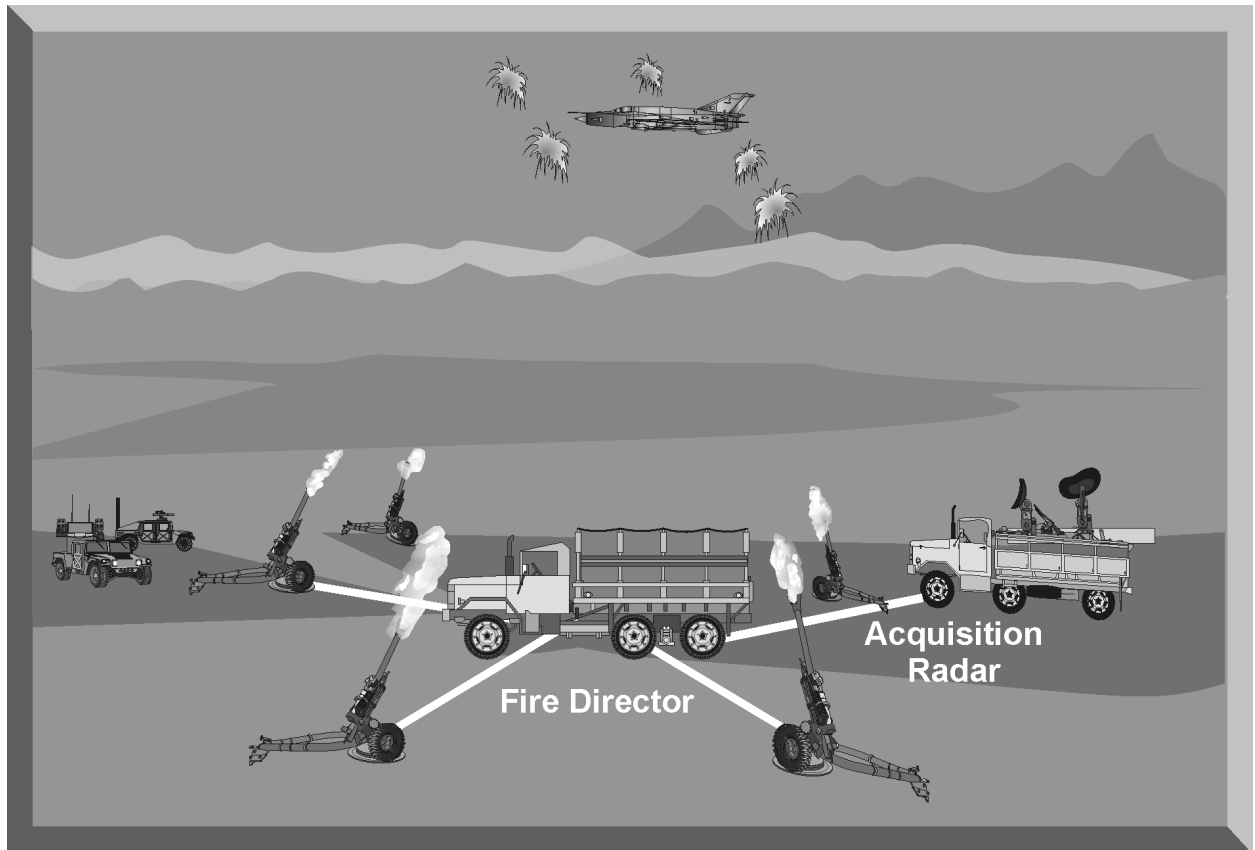

Figure 8-13. Optically Aimed AAA

(1) The typical engagement sequence for an aimed AAA engagement employing a TTR and fire control computer begins with initial target data from an acquisition radar. The guns and TTR are pointed toward the target. The TTR initiates search and lock-on to the target. The TTR associated with large caliber AAA is usually a conical scan radar to provide accurate target positioning information. Target information is fed into the fire control computer which calculates the aim point, points the guns, and initiates firing. The fire control computer uses the target kinematic data, gun ballistics, wind, air density, and projectile dispersion pattern to compute the required aim point. All these computations are based on the assumption that the target will continue on the same heading, at the same altitude, and at the same airspeed during the projectile TOF.

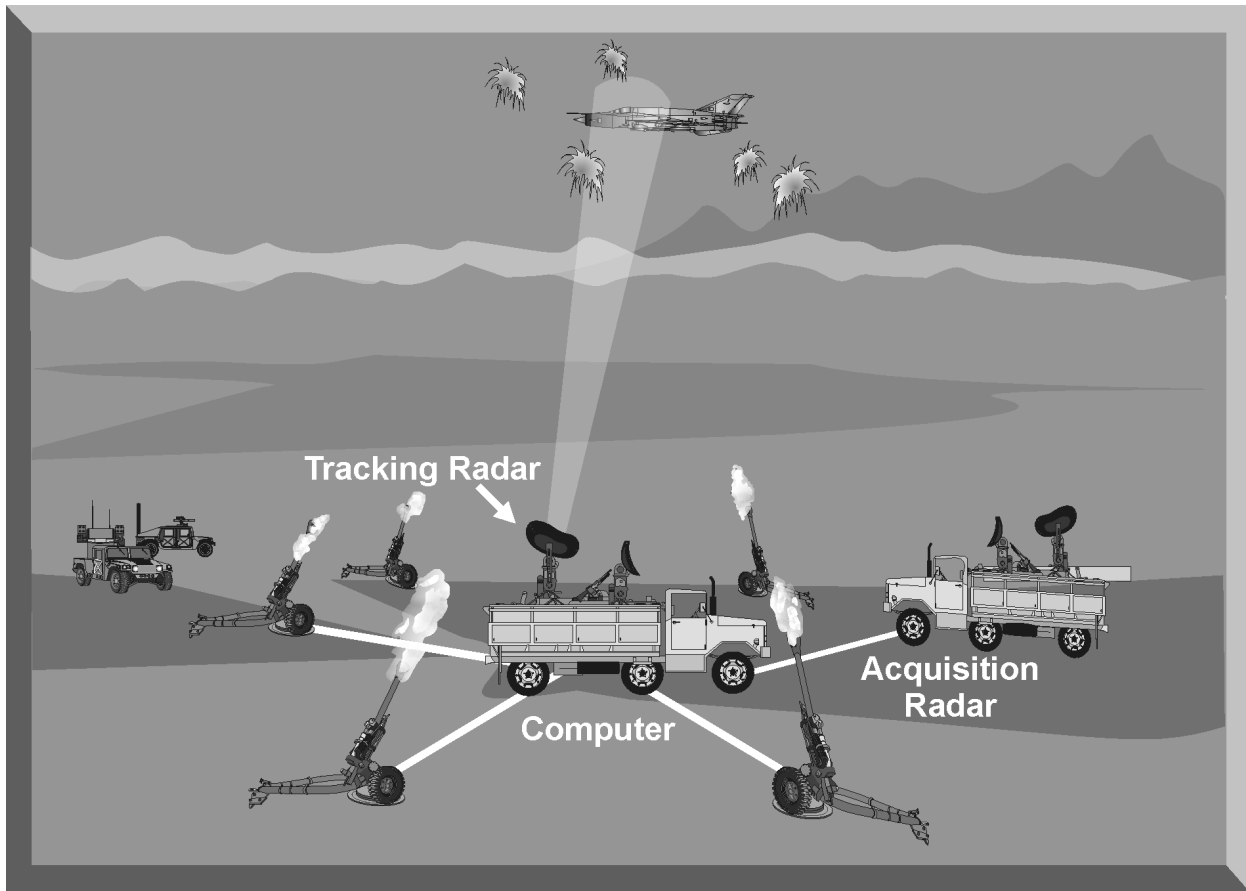

Figure 8-14. Radar-Directed AAA

(2) The typical engagement sequence for an aimed AAA engagement, employing optical target tracking begins with initial target information from an acquisition radar to the fire director. The fire director gives gross aiming commands to the individual guns. The gunners then visually search for the target and use the on-carriage gun sights to predict the required lead angle and initiate firing.

b. Sector or barrage fire tactics are employed when the aircraft cannot be accurately tracked (Figure 8-15). Acquisition information suggests an aircraft will traverse a volume of airspace or a specific sector. The fire director instructs the gunners to fire randomly into this sector in an effort to hit the aircraft with the barrage of AAA fire, or have the aircraft fly into a “curtain” of AAA fire. This tactic is especially effective for point defense for a fixed target. Attacking aircraft may have to fly a predictable flight path during weapons delivery. Sector/barrage fire can be directed to cover the expected attack directions and altitudes.

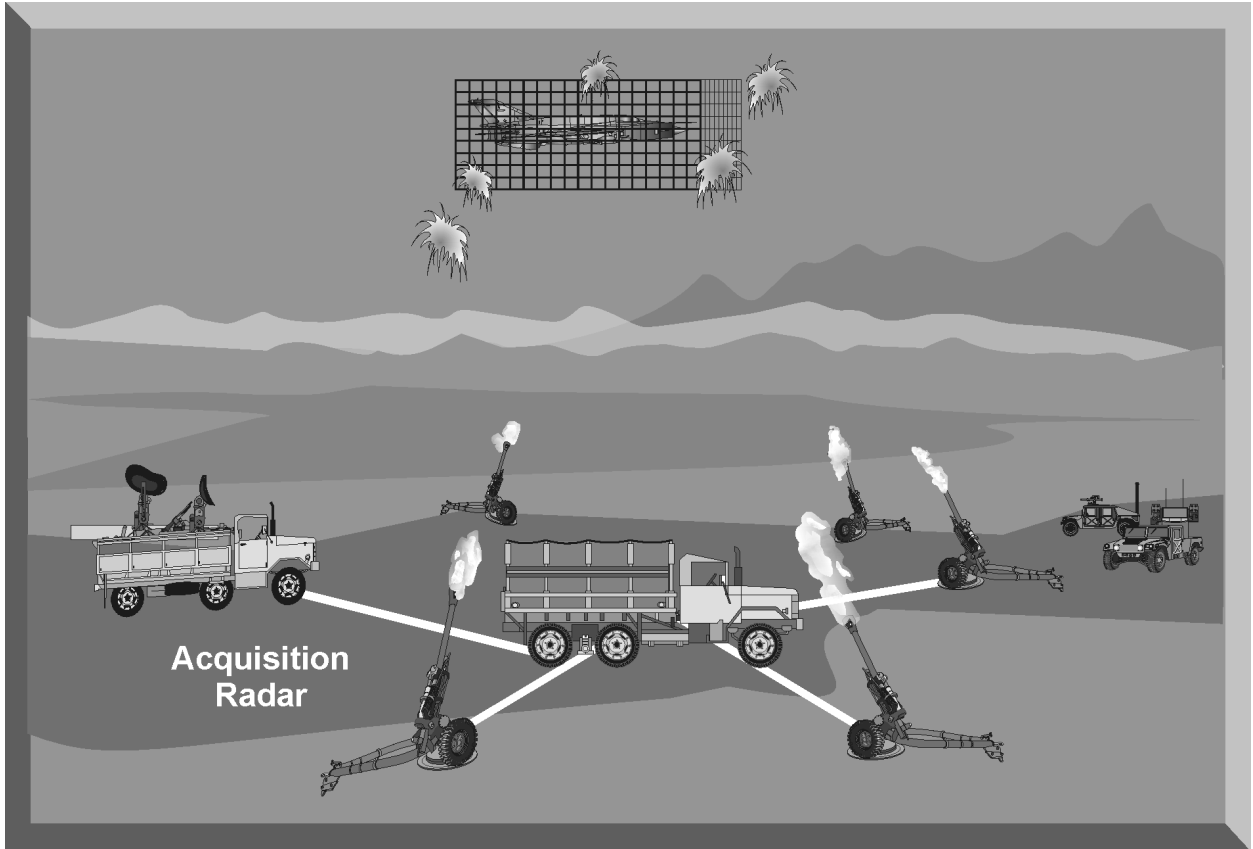

Figure 8-15. Sector/Barrage AAA

7. SUMMARY

This chapter has discussed the most common missile guidance techniques and AAA firing modes used by modern threat systems. A familiarity with the guidance technique employed by specific threat systems is the key to understanding the jamming techniques, chaff/flare employment settings, and tactical maneuvers designed to counter these systems.

CHAPTER 9. INTRODUCTION TO RADAR JAMMING

1. INTRODUCTION

Radar jamming is the intentional radiation or reradiation of radio frequency (RF) signals to interfere with the operation of a radar by saturating its receiver with false targets or false target information. Radar jamming is one principal component of electronic combat (EC). Specifically, it is the electronic attack (EA) component of electronic warfare (EW). Radar jamming is designed to counter the radar systems that play a vital role in support of an enemy integrated air defense system (IADS). The primary purpose of radar jamming is to create confusion and deny critical information to negate the effectiveness of enemy radar systems. This chapter will introduce the two types of radar jamming, the three radar jamming employment options, and discuss the fundamental principles that determine the effectiveness of radar jamming.

2. RADAR JAMMING TYPES

There are two types of radar jamming: noise and deception.

a. Noise jamming is produced by modulating a RF carrier wave with noise, or random amplitude changes, and transmitting that wave at the victim's radar frequency. It relies on high power levels to saturate the radar receiver and deny range and, occasionally, azimuth and elevation information to the victim radar (Figure 9-1). Noise jamming takes advantage of the extreme sensitivity of the radar receiver and the transmission pattern of the radar antenna to deny critical information to the victim radar.

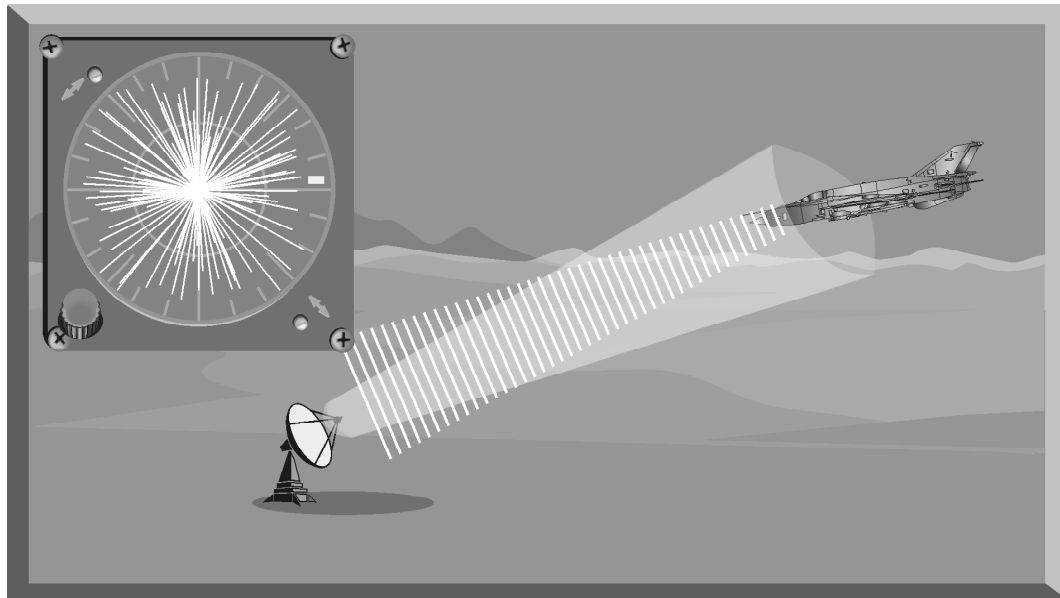

Figure 9-1. Noise Jamming

b. Deception jamming uses complex receiving and transmitting circuits to process and retransmit jamming pulses that appear as a real target to the victim radar. A deception jammer receives the signal from the victim radar and alters the signal to provide false range, azimuth, or velocity information. The altered signal is then retransmitted (Figure 9-2). The victim radar processes this signal, which disrupts the victim radar and confuses the radar operator. To be effective, deception jamming must match not only the victim radar's operating frequency, but all the other operating characteristics, including pulse repetition frequency (PRF), pulse repetition interval (PRI), pulse width, and scan rate.

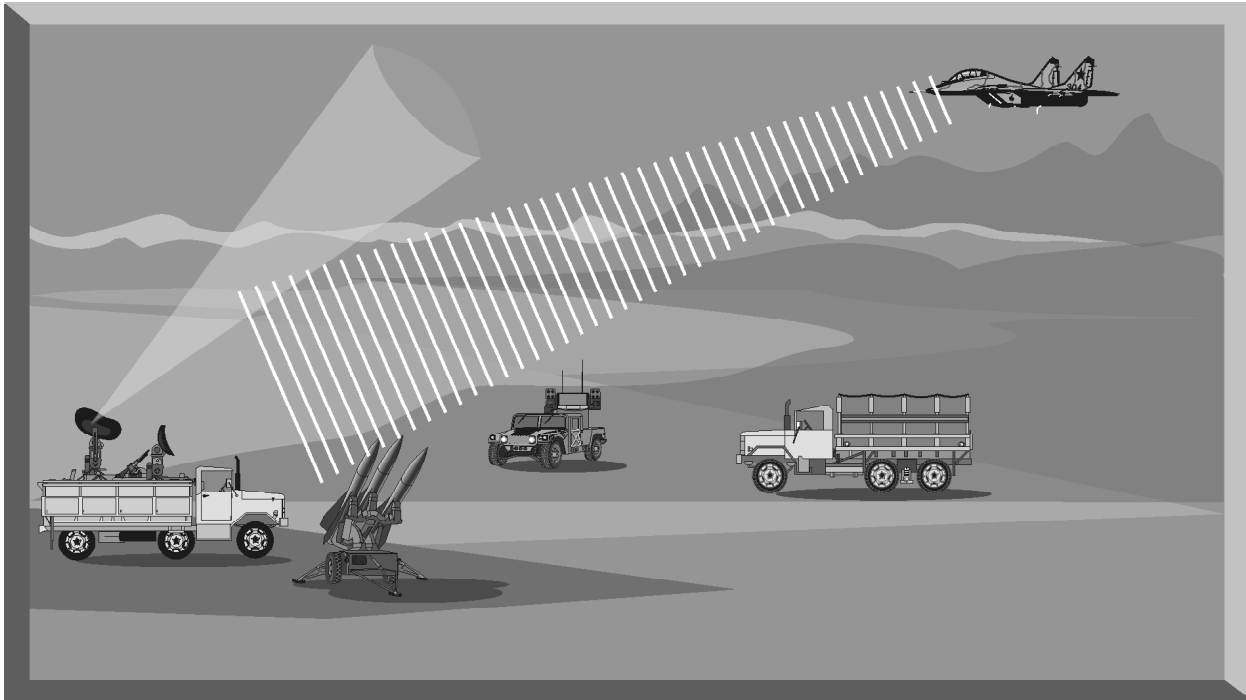

Figure 9-2. Deception Jamming

c. Both noise and deception jamming effectiveness are heavily dependent on another component of EW, specifically, electronic warfare support (ES). ES assets, either airborne or ground-based, provide the threat system specific radar parametric data and update this critical information based on observed threat system operations. This data provides the foundation for developing noise and deception jamming techniques. Intelligence and engineering assessment of this data are used to identify specific threat system weaknesses that can be exploited with the optimum noise, deception, or combination of jamming techniques. This information is then programmed into jamming systems to counter specific threats.

3. RADAR JAMMING EMPLOYMENT OPTIONS

There are currently two primary employment options for both noise and deception jamming techniques. These options are: (1) support jamming, and (2) self-protection jamming. Support jamming can be broken down further into stand-off jamming (SOJ), and escort jamming.

a. To counter early warning, ground control intercept (GCI), and acquisition radars associated with an enemy IADS, noise and deception jamming techniques are employed by specialized support jamming aircraft. The goal of support jamming is to create confusion and delays within the command and control structure of the IADS. Deny, delay or degrade the enemy's ability to engage friendly forces. Support jamming operations can be focused against a national level IADS through the use of a stand-off jamming (SOJ) profile (Figure 9-3) or against a target area threat array using an escort jamming profile.

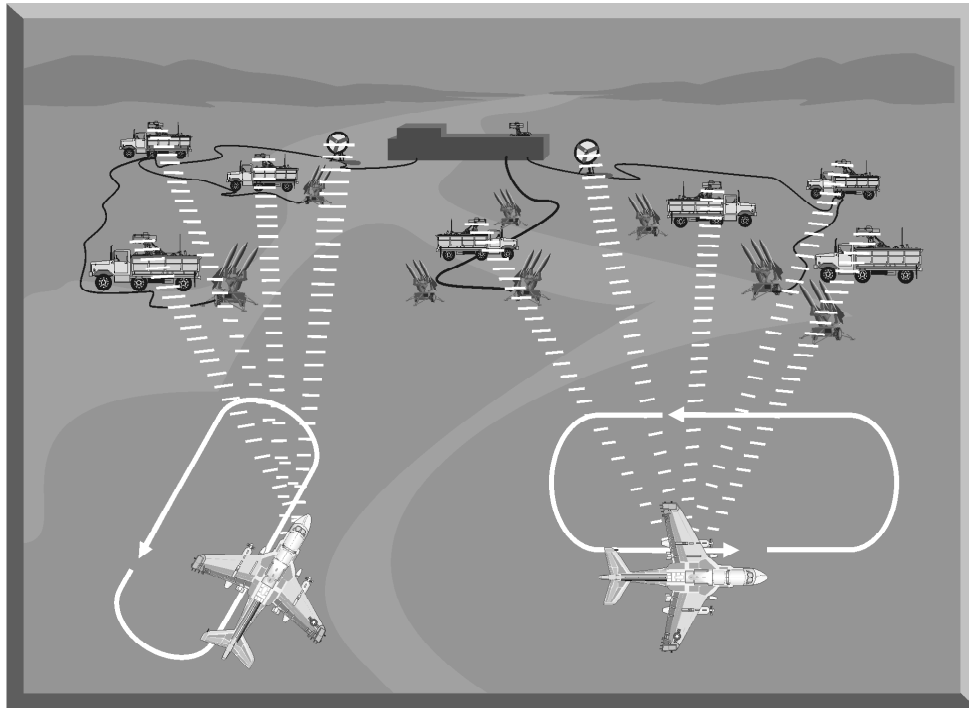

Figure 9-3. Stand-Off Jamming

(1) From an orbit area outside the surface-to-air missile (SAM) engagement zone, SOJ aircraft employ specialized jamming techniques to deny the enemy information about the attack package. SOJ aircraft employ specialized noise jamming techniques to generate jamming strobes on the victim radar display. This effectively denies range and azimuth information on aircraft ingressing and egressing the area covered by the noise jamming strobes. Intensity of the strobes is based on the power in the jamming. The area covered is based on the amount of jamming that can be injected into the main beam and sidelobes of the victim

radar. The effectiveness of SOJ noise jamming is determined by the power the jammer can generate relative to the power the victim radar can generate. This is called the jamming-to-signal (J/S) ratio.

(2) SOJ aircraft can also employ a deception technique to generate false targets to confuse the radar operator and mask the presence of real targets (Figure 9-4). In this specialized technique, the deception jammer must tune to the frequency, PRF, and scan rate of the victim radar. The jammer then transmits multiple jamming pulses that the victim radar receiver processes like real target returns. With enough power, the deception jammer can generate multiple false azimuth targets by injecting jamming pulses into the sidelobes of the victim radar. False moving targets and false range targets are generated by varying the time delay of the jamming pulses based on the PRF and scan rate of the victim radar.

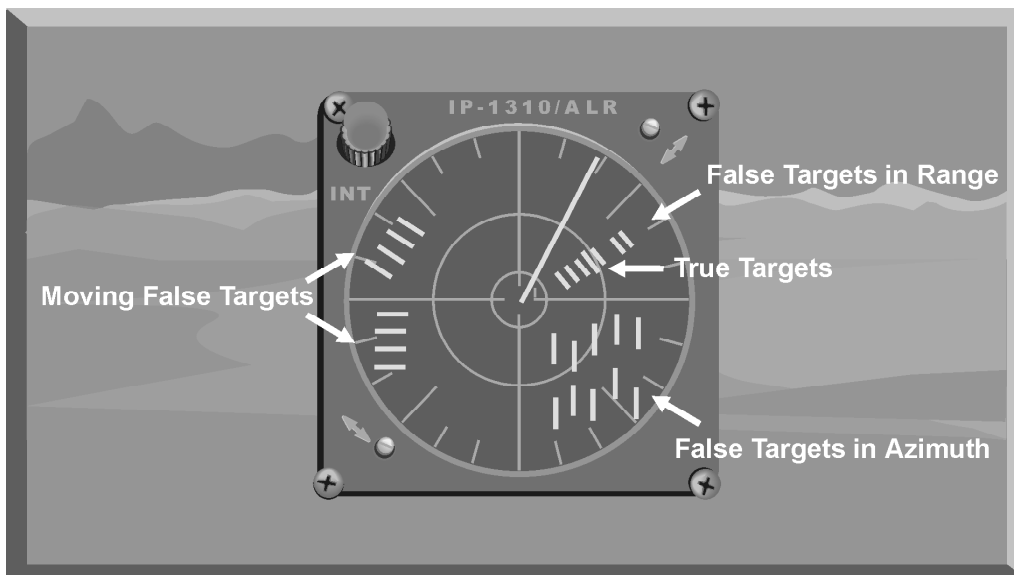

Figure 9-4. False Target Jamming

(3) Escort jamming is a specific tactic used by the EA-6B Prowler. The EA-6B is employed as an integral part of the attack package and is normally positioned behind and above the attack package (Figure 9-5).

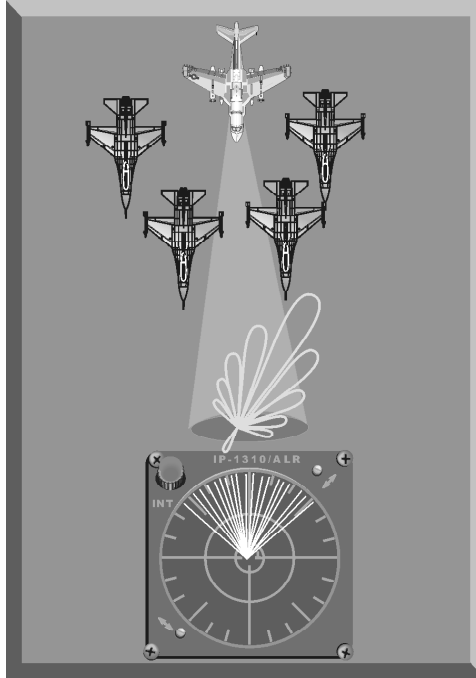

Figure 9-5. Escort Jamming

Using noise jamming, the EA-6B attempts to deny range and azimuth information to the victim radar by injecting high power signals into the main radar beam and sidelobes. To be effective, the EA-6B must be properly positioned in relation to the ingressing or egressing attack package (Figure 9-6).

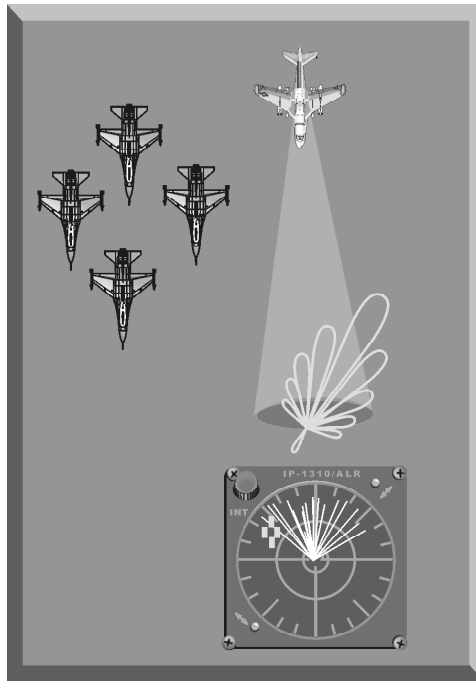

Figure 9-6. Escort Jamming Alignment

b. Self-protection radar jamming targets the radar systems that support jamming cannot negate. Self-protection jamming systems are part of a self-protection suite that includes a self-protection jamming pod, a chaff/flare dispenser, and on some aircraft, a towed decoy system. The overall purpose of these systems is individual aircraft survivability. These systems are designed to counter the individual SAM, AAA, and AI assets associated with the enemy IADS. They employ deception jamming techniques against the target tracking radars (TTRs) associated with these threats. They are designed to break the radar track or generate sufficient tracking errors to cause the missile or bullet to miss the aircraft.

(1) Self-protection radar jamming systems usually employ deception jamming techniques based on several factors. First, effective deception jamming techniques generally require less power than noise jamming techniques. Second, less power means less weight and space, which are very important considerations for modern tactical aircraft. Finally, deception jammers can be designed to jam multiple threats, which is a critical requirement for operations in a dense threat environment (Figure 9-7).

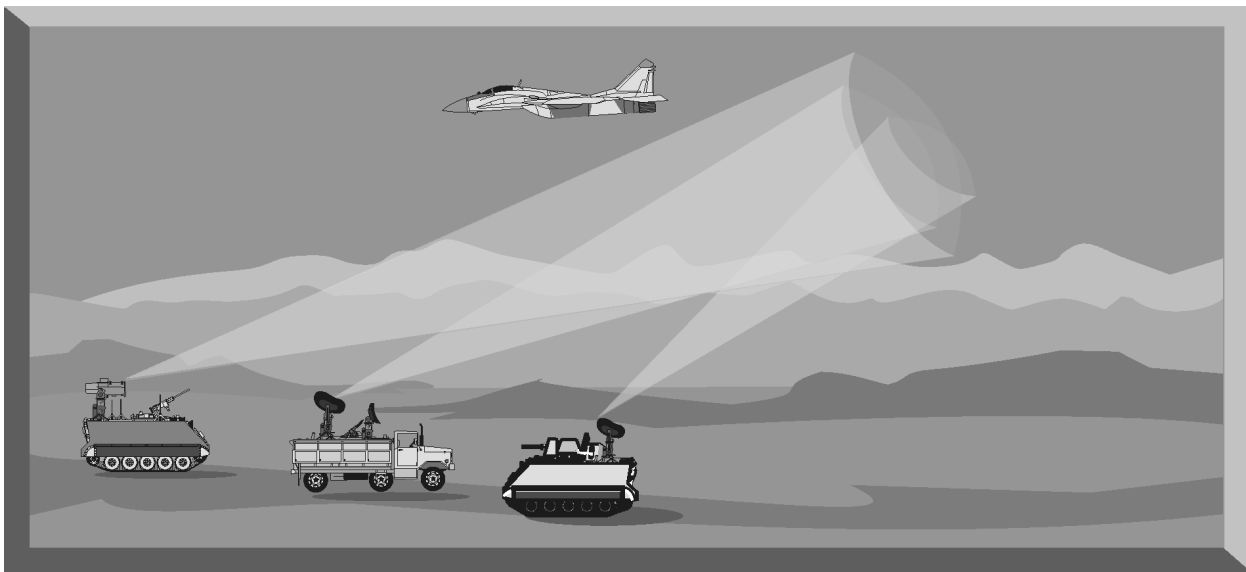

Figure 9-7. Self-Protection Jamming

(2) Despite the advantages of deception jamming techniques for self-protection jamming, there are some limitations that must be considered. First, deception jammers are complex electronic systems that must receive a victim radar's signal, memorize all its characteristics, modify the signal, and retransmit this modified signal at a high power level. Second, to be effective, deception jammers must be programmed with all the signal parameters (frequency, PRF, PRI, pulse width, scan rate, etc.) of the victim radar. Finally, because many deception techniques can be effective against specific threats, selecting optimum techniques to employ against these threats must be based on identified threat

system limitations. Identifying these specific threat systems limitations may be difficult.

4. FUNDAMENTALS OF RADAR JAMMING

There are some fundamental principles that apply to all types of jamming and to all jamming employment options. These principles are based on the characteristics of the jamming system and the characteristics of the victim radar. They include frequency matching, continuous interference, signal-to-noise ratio, jamming-to-signal ratio, and burnthrough range.

a. Based on the data provided by ES systems and intelligence evaluations, radar jamming systems must transmit signals at the frequency of the victim radar. This applies to both noise and deception jamming. If a jamming signal does not match the transmitter frequency, the jamming signal is not received and displayed on the scope (Figure 9-8). When a jamming signal matches the transmitter frequency, the jamming signal is received and masks the target display (Figure 9-9).

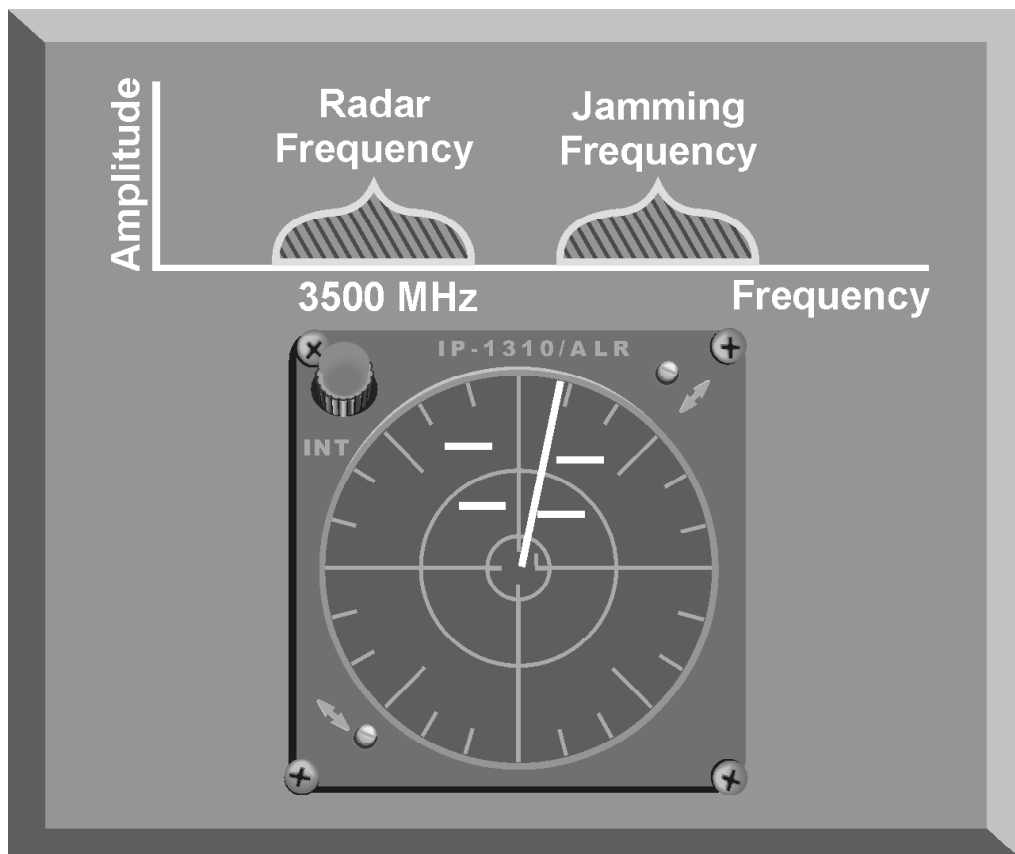

Figure 9-8. Jamming Frequency Error

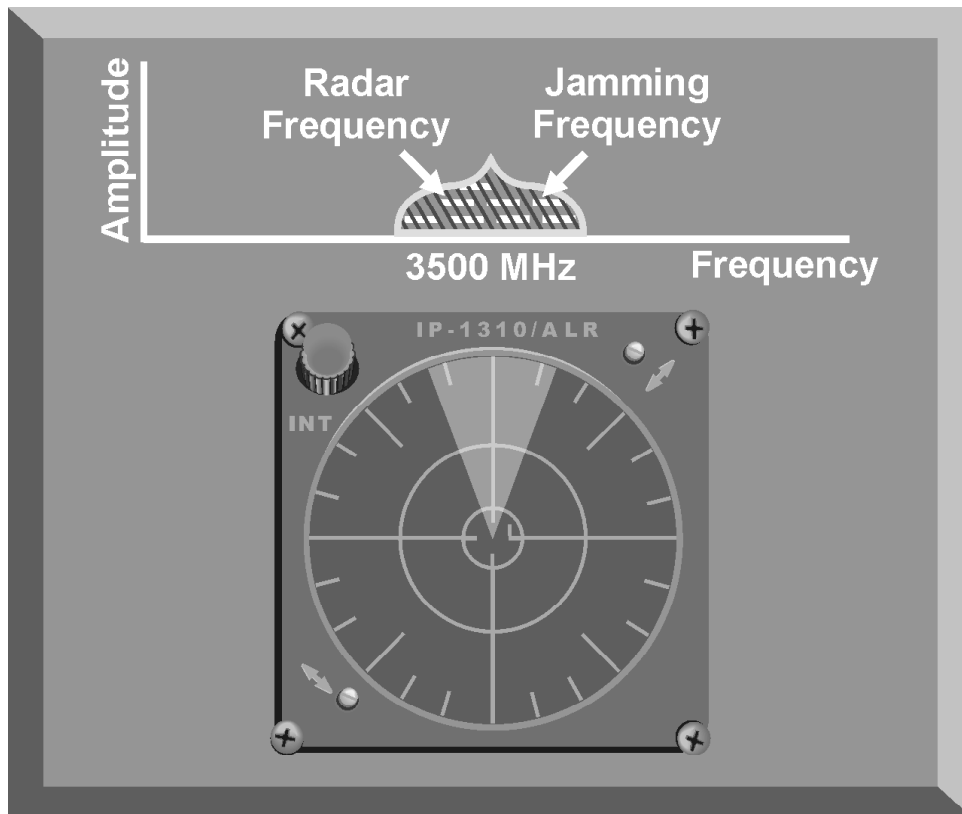

Figure 9-9. Correct Jamming Frequency Matching

b. For maximum effectiveness, a jamming transmitter should produce continuous interference. In much the same way intermittent static on a radio receiver does not completely block out a signal, intermittent jamming on a radar scope may not completely mask the target. An experienced radar operator or advanced automatic tracker can “read through” intermittent jamming and derive sufficient target information to negate jamming effectiveness. While true for noise jamming techniques, continuous interference also applies to deception techniques, especially when target reacquisition is considered.

c. The signal-to-noise (S/N) ratio is a measure of the ability of the victim radar to detect targets. It is also an indication of the vulnerability of the radar to certain jamming techniques, especially noise jamming.

(1) From the discussion of the basic radar equation in Chapter 5 (Equation 5-10), Equation 9-1 is the signal power density of a target return at the radar receiver. The signal power density of the target return is so weak that it requires very strong amplification before processing and display. Besides the signal power from the target, some level of thermal noise is also generated and amplified along with the target signal. For an “ideal” (no noise) amplifier, Equation 9-2 is used to compute the level of thermal noise generated by the amplifier.

$$\text{Signal Power Density} = \frac{P_T G \sigma A_e}{(4\pi)^2 R^4}$$

P_T = transmitted power
 G = antenna gain
 σ = target radar cross section (RCS)
 A_e = antenna aperture area
 R = range to the target

Equation 9-1. Signal Power Density

$$\text{Thermal Noise (N)} = KTB F$$

K = Boltzman's Constant
 (1.38 x 10⁻²³ watts/Hz degrees K)
 T = standard temperature (290° K)
 B = radar receiver equivalent bandwidth
 F = radar receiver noise figure
 (one for "ideal" receiver)

Equation 9-2. Thermal Noise

Note: The instantaneous bandwidth of a receiver is the frequency range over which the receiver can simultaneously amplify two or more signals to within a specified gain.

(2) The radar receiver amplifies both target signal and thermal noise. The output of the radar receiver will contain the target signal and the noise amplified across the bandwidth of the receiver. Separating the desired target signal from the undesired noise signal is one of the major problems confronting radar designers.

(3) Equation 9-3 is derived by dividing Equation 9-1 by Equation 9-2. Many factors in this equation fluctuate and must be estimated using statistical calculations. For example, target RCS fluctuates based on the changing angle of the antenna beam and corresponding changes in the reflected signal. Effective antenna aperture is also a statistical phenomenon based on the fluctuations in target RCS. The thermal noise generated by a receiver is also a fluctuating factor and must be treated statistically. This means that the S/N ratio is a statistical factor associated with a probability of target detection and a probability of a false alarm. A false alarm occurs when the radar operator or automatic tracking circuit designates a fluctuation in noise level as a target. The higher the S/N ratio, the

higher the probability of target detection with a corresponding reduction in the probability of a false alarm.

$$\text{Signal-to-Noise Ratio} = \frac{P_T G \sigma A_e \left(\frac{1}{(4\pi)^2 R^4} \right)}{KTBF}$$

P_T = transmitted power

G = antenna gain

σ = target radar cross section (RCS)

A_e = antenna aperture area

R = range to the target

K = Boltzman's Constant

(1.38×10^{-23} watts/Hz degrees K)

T = standard temperature (290° K)

B = radar receiver equivalent bandwidth

F = radar receiver noise figure
(one for "ideal" receiver)

Equation 9-3. Signal-to-Noise Ratio

(4) An analysis of Equation 9-3 suggests that any action that increases the power in the target signal (for example, increasing transmitted power, increasing antenna gain/aperture area, or decreasing target range) will improve the S/N ratio and improve the probability of target detection. It would also appear that decreasing the bandwidth of the radar receiver will increase the S/N ratio and enhance the probability of target detection. However, if the effective bandwidth of the receiver is reduced, this may eliminate a significant portion of the radar signal spectrum and decrease the probability of target detection.

(5) The S/N ratio is also an indication of the range at which a target will be detected. A plot of the receiver output of a typical radar is shown in Figure 9-10. The weak target signal at an extended range is just above the receiver noise level. The target at closer range is easily detected above the noise level. A radar operator or automatic target detector could mistake the very weak target return as a fluctuation in the receiver noise level. This could result in a missed detection. The lack of discrimination between noise and target returns because of a poor S/N ratio can also result in designating fluctuations in the noise level as actual target signals, known as false alarms.

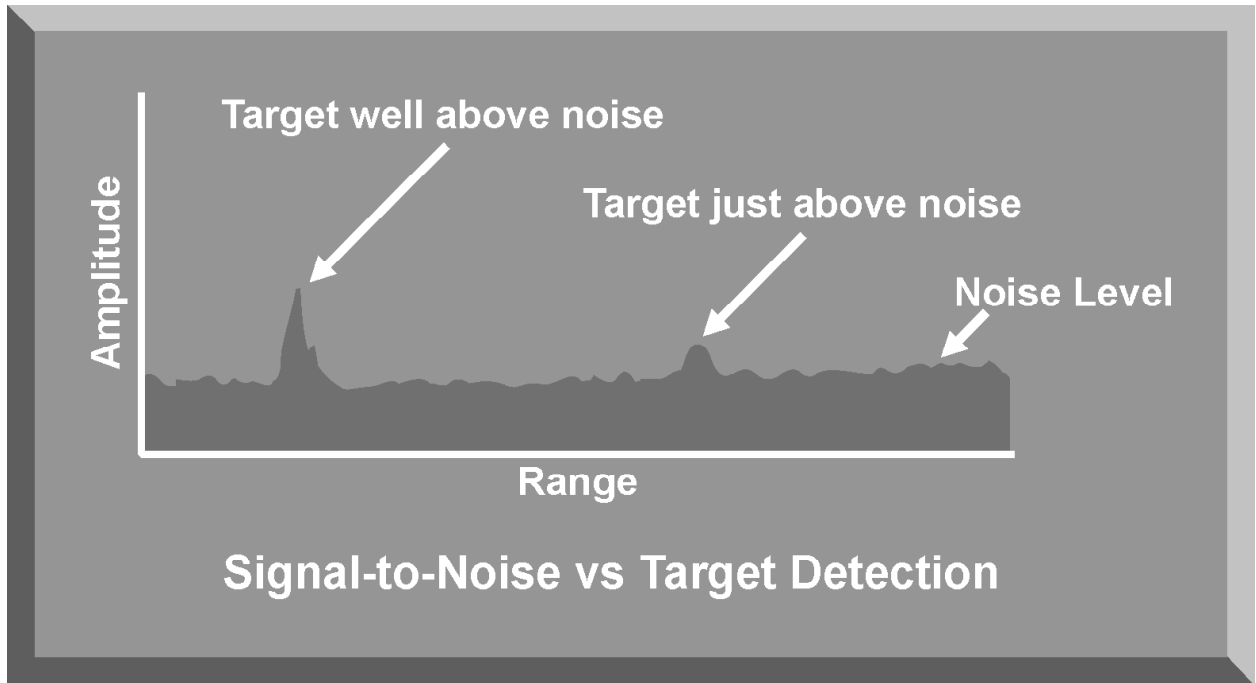

Figure 9-10. S/N Ratio and Target Detection

(6) To preclude, or minimize false alarms, the radar receiver may be equipped with electronic circuits to establish a false alarm threshold. If the signal strength of a radar return is below this threshold level, it will not be detected or displayed (Figure 9-11). This false alarm threshold also influences the probability of target detection. With the threshold set too high, many detected targets will not be displayed. Additionally, if the false alarm threshold is raised automatically in relation to the amplitude of the receiver noise, the radar receiver is more vulnerable to noise jamming.

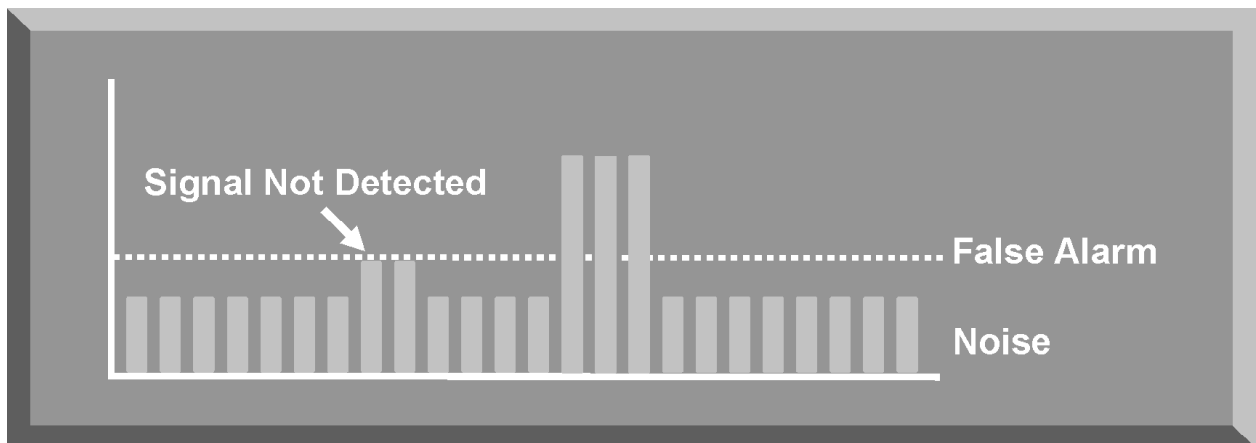

Figure 9-11. Receiver False Alarm Threshold

(7) For any target return to be detected by the radar, the S/N ratio must be greater than one. If the S/N ratio is less than one, the target will not be detected above the receiver noise level. The purpose of noise jamming is to raise the level of noise in the radar receiver to reduce the S/N ratio to less than one. This masks the presence of the true target return. If a false alarm threshold is used, noise jamming raises this threshold to further complicate target detection. Figure 9-12 depicts a S/N ratio greater than one. Figure 9-13 depicts a S/N ratio of less than one due to noise jamming.

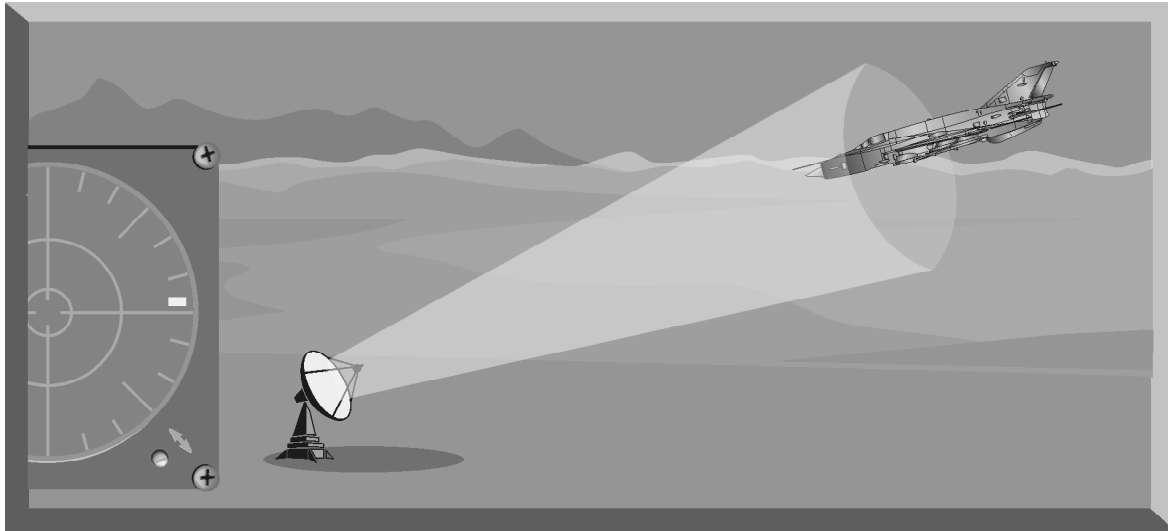

Figure 9-12. S/N Ratio Greater Than One

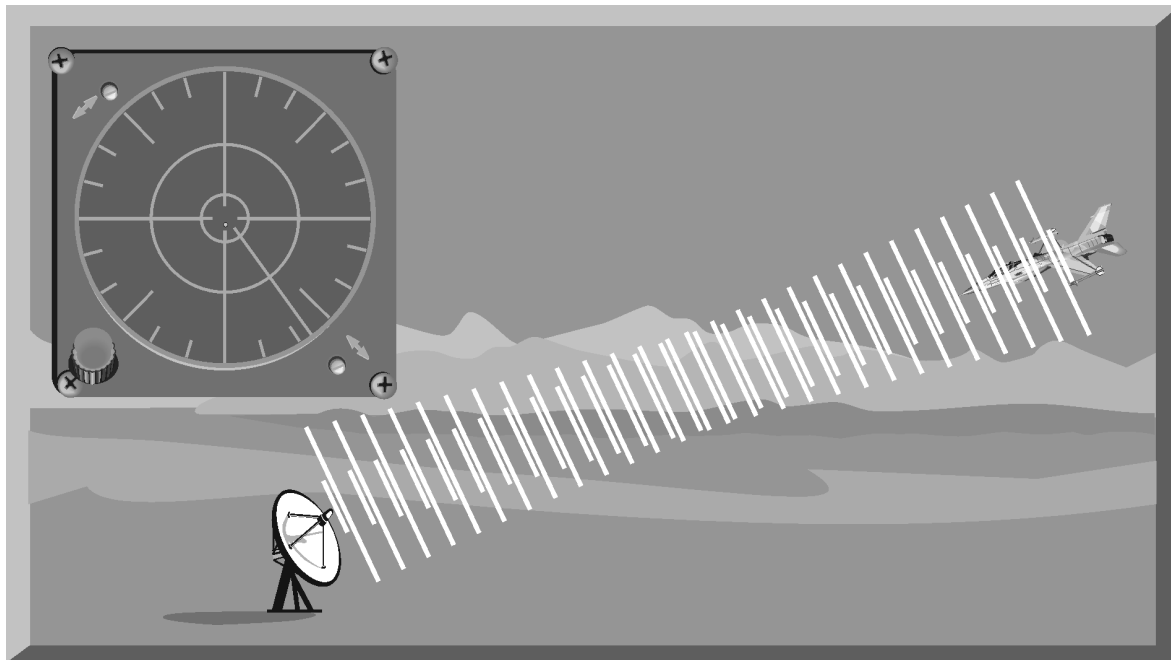

Figure 9-13. S/N Ratio Less Than One

d. The jamming-to-signal (J/S) ratio is a fundamental measure of jamming effectiveness. The J/S ratio compares the power in the jamming signal with the power in the radar return. Equation 9-4 is an expression of the J/S ratio. It is important to note that the J/S ratio should be measured at the output of the radar receiver. This will allow consideration of the receiver signal processing gain applied to the jamming signal.

$$\text{Jamming-to-Signal Ratio} = \frac{P_J G_J}{P_T G_T} \times \frac{4\pi R^2}{\sigma}$$

P_J = jamming power transmitted

G_J = jamming antenna gain

P_T = peak power transmitted by the radar

G_T = radar antenna gain

R = range from jammer to radar

σ = aircraft RCS

Equation 9-4. Jamming-to-Signal Ratio

(1) The most critical factor in both the S/N and the J/S ratios is range. The S/N ratio is calculated based on R to the fourth power. This equates to a signal traveling from the radar to the target, and back to the radar receiver. The J/S ratio is calculated using R to the second power. This factor reflects the “one way” transmission of the jamming pulse from the jammer to the victim radar's receiver.

(2) For a jamming signal to be effective, the J/S ratio must be greater than one. In general, threat radars, especially ground-based radars, transmit much more power than does an airborne jamming system. However, this power must travel twice as far as the airborne jamming signal. At long ranges, a low power jamming system can generate a J/S ratio much greater than one. In Figure 9-14, the jamming pulse completely masks the target return. As the jamming system approaches the target, the distance the radar pulse travels decreases with a corresponding increase of power in the radar return. This reduces the J/S ratio to a value less than one and the radar “sees” the target. This is called the burnthrough range (Figure 9-15).

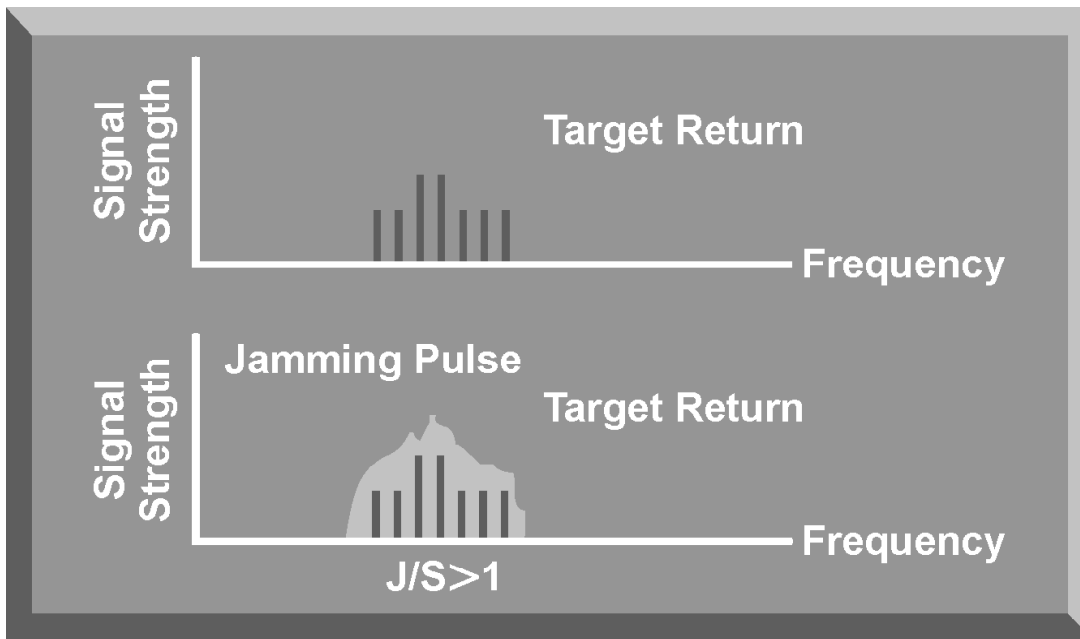

Figure 9-14. J/S Ratio Greater Than One

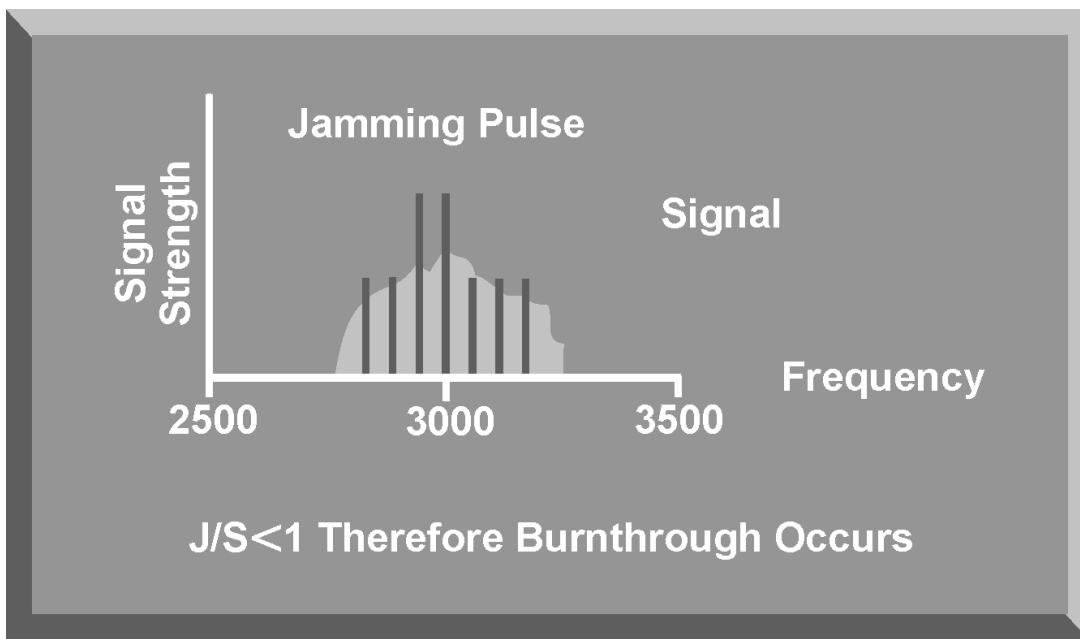

Figure 9-15. J/S Ratio Less Than One

e. Burnthrough occurs when the power in the reflected target signal exceeds the power in the jamming signal. Even when an optimum and continuous jamming technique is transmitting on the exact frequency of the victim radar, the jamming starts to lose effectiveness as it nears the radar. For a particular radar

jamming technique, burnthrough range depends on the detection capability of the victim radar, expressed as the S/N ratio, and the capability of the aircraft's jamming system, expressed as the J/S ratio. The idea of burnthrough range explains why a jamming technique, especially noise jamming, loses its effectiveness as the aircraft approaches the radar. When plotting the jamming and signal power versus range (Figure 9-16), these two values intersect at the point where the J/S ratio is one. At closer ranges, the jamming pulse is no longer masking the aircraft, and the aircraft can be detected. Burnthrough range is the point where the radar can see through the jamming.



Figure 9-16. Burnthrough Range

5. SUMMARY

The purpose of radar jamming is to confuse or deny critical data to the radar systems that play a vital role in supporting the mission of an integrated air defense system. Two types of radar jamming, noise and deception, can be employed in a support-jamming role, or in a self-protection role for individual aircraft. The effectiveness of a jamming technique depends on the ability of the jamming system to generate a jamming signal that replicates the parameters of the victim radar, especially its frequency. The signal-to-noise ratio of the victim radar determines the vulnerability of the radar receiver to jamming while the jamming-to-signal ratio is an indication of the ability of the jamming system to effectively jam the victim radar. These basic radar jamming concepts are fundamental to understanding the impact of specific jamming techniques on radar systems.

CHAPTER 10. RADAR NOISE JAMMING

1. INTRODUCTION

A radar noise jamming system is designed to generate a disturbance in a radar receiver to delay or deny target detection. Since thermal noise is always present in the radar receiver, noise jamming attempts to mask the presence of targets by substantially adding to this noise level. Radar noise jamming can be employed by support jamming assets or as a self-protection jamming technique. Radar noise jamming usually employs high-power jamming signals tuned to the frequency of the victim radar. This chapter will discuss the factors that determine the effectiveness of radar noise jamming, radar noise jamming generation, and the most common noise jamming techniques. These noise jamming techniques include barrage, spot, swept spot, cover pulse, and modulated noise jamming.

2. RADAR NOISE JAMMING EFFECTIVENESS

The effectiveness of radar noise jamming depends on numerous factors. These factors include the jamming-to-signal (J/S) ratio, power density, the quality of the noise signal, and the polarization of the transmitted jamming signal (Figure 10-1).

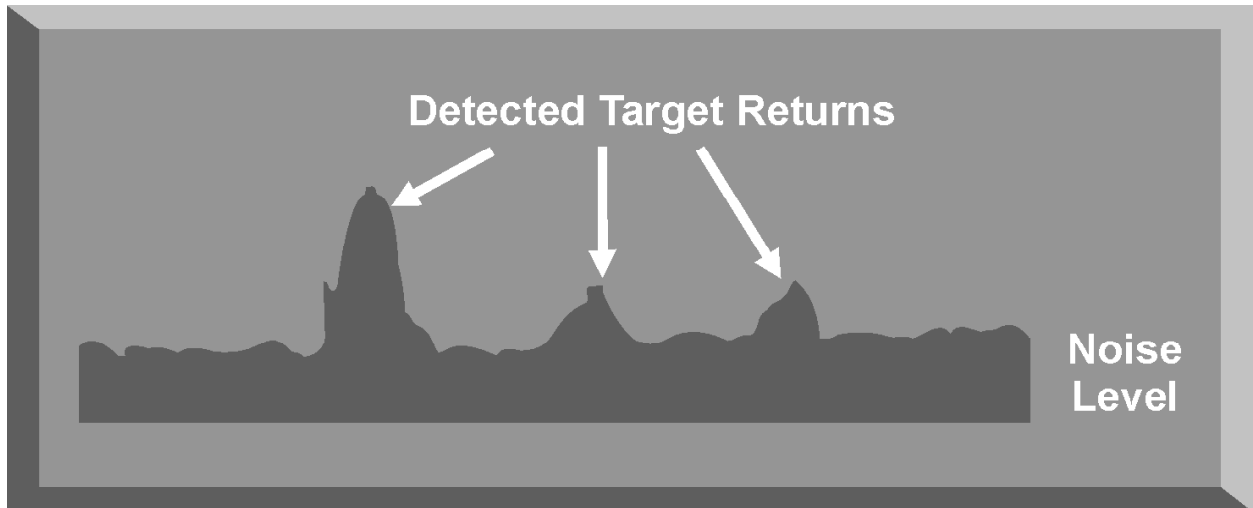

Figure 10-1. Noise Level in a Typical Radar Receiver Output

a. One of the most important factors that impacts the effectiveness of radar noise jamming is the J/S ratio (Figure 10-2). As discussed in Chapter 9, the power output of the noise jammer must be greater than the power in the target return, as measured at the output of the radar receiver. To achieve this level of jamming power, radar noise jammers usually generate high-power jamming signals. These high-power jamming signals can be introduced into the victim radar's main beam

to deny range information and into the victim radar's sidelobes to deny azimuth information.

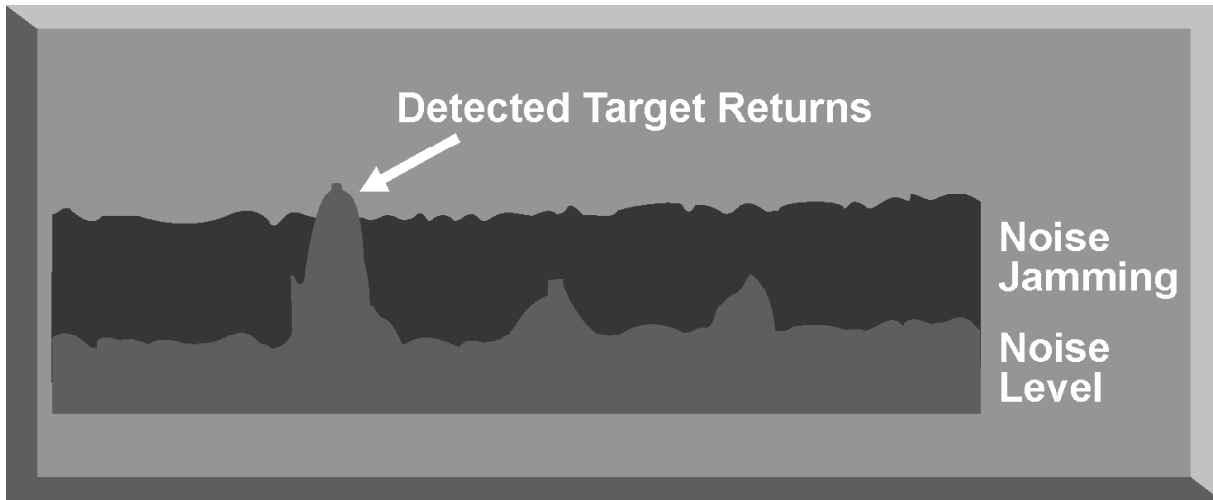

Figure 10-2. Impact of Noise Jamming

b. Another factor which impacts the effectiveness of radar noise jamming is the power density. The power density of the noise jamming signal has a direct relation to the J/S ratio.

(1) If the noise jamming signal is centered on the frequency and bandwidth of the victim radar, the jamming signal has a high power density. The ability of a noise jammer to concentrate the jamming signal depends on the ability of the jammer to identify the exact frequency and bandwidth of the victim radar (Figure 10-3).

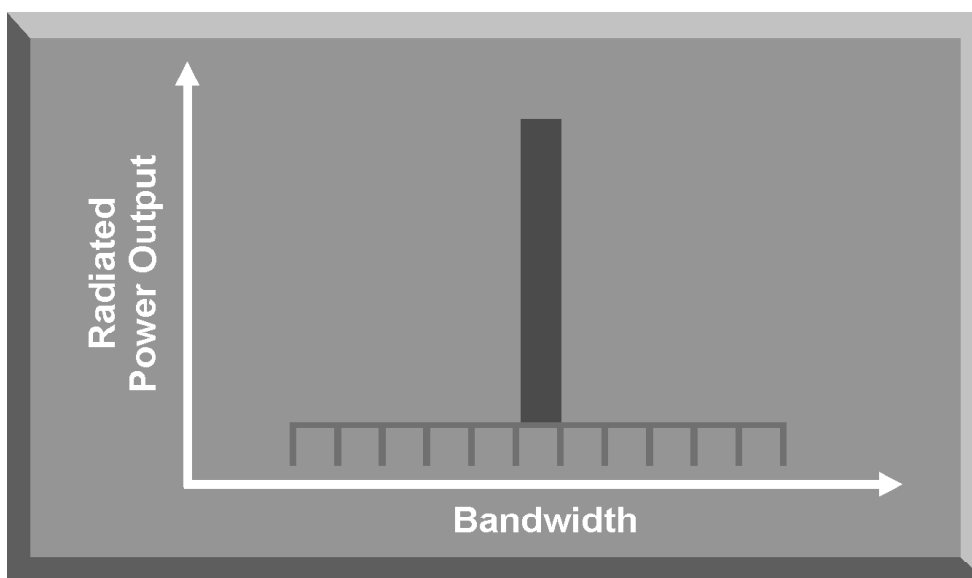

Figure 10-3. Power Density – Narrow Bandwidth

(2) If the generated noise jamming signal has to cover a wide bandwidth or frequency range, the power density at any one frequency is reduced (Figure 10-4). Radar systems that are frequency agile or that employ a wide bandwidth can reduce, or negate, the effectiveness of noise jamming by reducing the power density of the jamming signal.

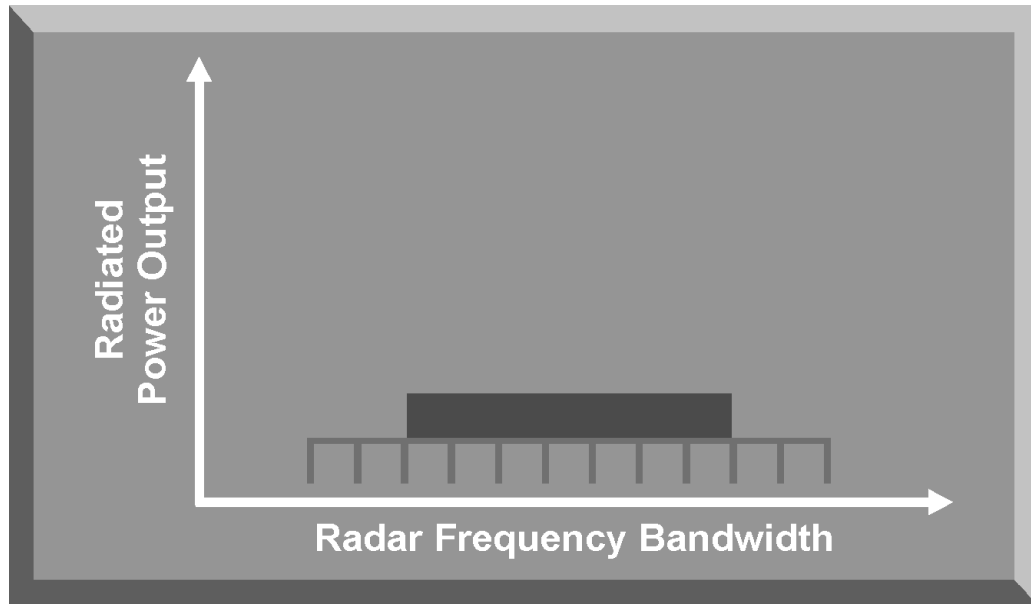

Figure 10-4. Power Density – Wide Bandwidth

c. The quality of the noise jamming also determines its effectiveness. To effectively jam a radar receiver with noise, the jamming signal must emulate the thermal noise generated by the receiver. This ensures that the radar operator or automatic detection circuit cannot distinguish between the noise jamming and normal thermal noise. Thermal noise is referred to as white noise and has a uniform spectrum. All of the frequencies in the bandwidth of the receiver have the same spectrum and an amplitude that varies based on Gaussian distribution. A Gaussian distribution is simply a bell-shaped distribution of amplitudes. In order to be effective, the jamming signal should exactly match the characteristics of the thermal noise signal of the victim radar receiver.

d. Polarization of the noise jamming signal is another significant factor that impacts its effectiveness. As discussed in Chapter 2, if the polarization of the jamming signal does not match the antenna polarization of the victim radar, there is a significant power loss in the jamming signal. Noise jamming systems designed to counter multiple threat radars, with various polarizations, generally use a transmitting antenna with a 45° slant or use circular polarization. Most threat systems are horizontally or vertically polarized. This results in a 50% reduction in effective radiated power (ERP) for most threat systems. A more serious power loss, nearly 100%, in ERP occurs when the jamming antenna is

orthogonally polarized with the victim antenna. The polarization of the noise jamming signal impacts the J/S ratio and the power density.

3. RADAR NOISE JAMMING GENERATION

Noise jamming is produced by modulating an RF carrier wave with random amplitude or frequency changes, called noise, and retransmitting that wave at the victim radar's frequency. Since noise from numerous sources is always present and displayed on a radar scope, noise jamming adds to the problem of target detection. Reflected radar pulses from target aircraft are extremely weak. To detect these pulses, a radar receiver must be very sensitive and be able to amplify the weak target returns. Noise jamming takes advantage of this radar characteristic to delay or deny target detection.

a. The simplest method of generating a high-power Gaussian noise jamming signal is to employ a highly amplified diode to generate a noise signal at the frequency of the victim radar. This signal is filtered and directly amplified to the maximum power that can be generated by the transmitter. This method is called direct noise amplification (DINA). The DINA method of noise generation has a serious limitation. The maximum power available from linear wideband power amplification is extremely limited. Employing any other form of power amplification would alter the Gaussian distribution of the jamming signal. This method of generating radar noise jamming was used extensively during WW II.

b. Modern noise jamming systems generate noise jamming signals by frequency modulating a carrier wave at the frequency of the victim radar. FM noise jammers employ a receiving antenna to intercept the victim's radar signal. The antenna passes the victim radar signal to the receiver for identification. The receiver also tunes the jamming signal generator to the correct frequency. The receiver uses an automatic frequency control (AFC) circuit to tune the voltage-controlled oscillator (VCO) to the frequency of the victim radar. A noise signal is generated by the jamming signal generator and added to the tuning voltage of the VCO to get an FM jamming signal. This signal is sent to a traveling wave tube (TWT) power transmitter. The TWT is normally operated in a saturated mode which produces a high-power jamming signal that covers a wider bandwidth than the victim radar. This reduces the power density of the signal, but the high power levels available from the TWT amplification of an FM signal compensate for this loss. The signal is sent to the transmitting antenna and directed toward the victim radar.

c. Figure 10-5 highlights an important feature of a modern radar noise jamming system: a look-through capability. A look-through mode allows the receiver to periodically sample the signal environment. The objective of the look-through mode is to allow the jammer to update victim radar parameters and change the jamming signal to respond to changes in the signal environment. This greatly enhances the effectiveness of noise jamming systems. One method used to provide a look-through capability is to isolate the transmit and receive

antennas to allow continuous operation of the receiver to update signal parameters. Another method is to switch off the jammer for a brief period to allow the receiver to sample the signal environment. Since this latter look-through method eliminates the jamming signal, the amount of time the jammer is switched off must be kept to a minimum.

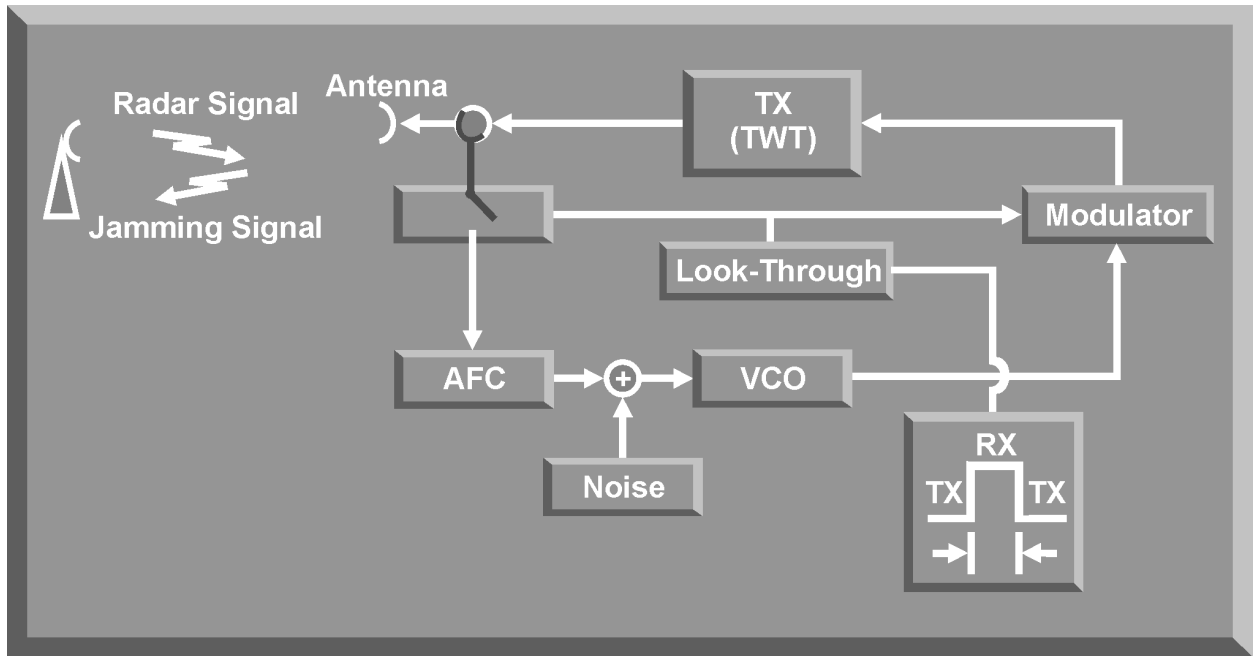

Figure 10-5. Frequency Modulated (FM) Noise Jamming System

4. BARRAGE JAMMING

An important aspect of jamming power is power density. Noise jamming depends on power density for its effectiveness. Power density is a function of the frequency range, or bandwidth, of the jamming signal. If a jammer covers a narrow frequency range, it can concentrate energy in a narrow band. If a jammer covers a wide frequency range, the energy is spread over that entire range. Since the jammer has fixed radiated power, this lowers the effective jamming power at a given frequency. Barrage jamming is a jamming technique where high power is sacrificed for the continuous coverage of several radar frequencies (Figure 10-6). The jamming signal is spread over a wide frequency range, which lowers the ERP at any one frequency. This type of jamming is useful against frequency-agile radars, against a radar system that uses multiple beams, or against multiple radar systems operating in a specific frequency range. By spreading the jamming over a wide frequency range, there is some level of jamming no matter what frequency the radar uses. Barrage jamming was used extensively during World War II. Advantages of barrage jamming are its simplicity and ability to cover a wide portion of the electromagnetic spectrum. The primary disadvantage is the low power density, especially when a high J/S ratio is needed against modern radars.

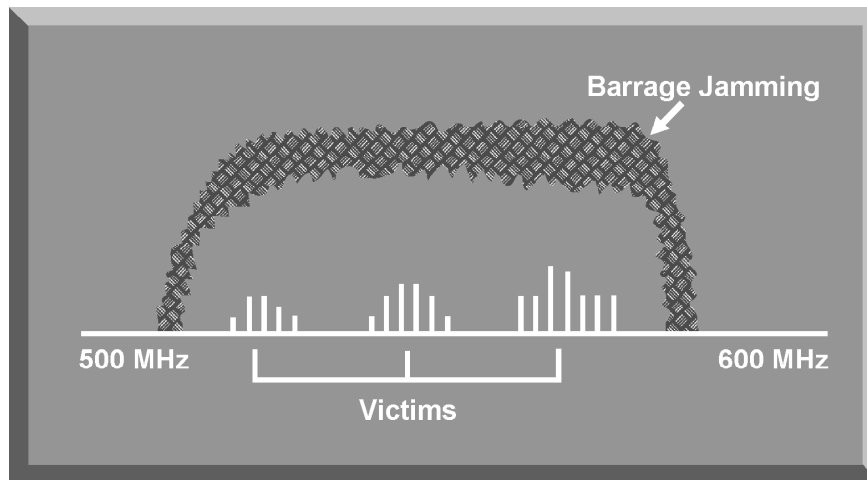

Figure 10-6. Barrage Jamming

5. SPOT JAMMING

One way to take advantage of the noise jammer's simplicity, but raise the jamming signal power, is to use a spot jammer. The earliest spot jammers were very narrow band jammers covering a bandwidth of 10 megahertz or less (Figure 10-7). This narrow band spot jammer was tuned to the anticipated frequency of the target radar. When it is necessary to jam a number of radars at different frequencies, more than one jammer is used. One problem that developed was of carrying the required number of spot jammers to counter a modern IADS. Also, radars that change their operating frequency, or are frequency-agile, defeat the spot jammer. Today, intercept panoramic receivers work with spot jammers to determine the frequency of the victim radar. A look-through capability is included in the system so that the target radar signal can be monitored to assess jamming effectiveness. The jamming signal can be adjusted for any changes in the operating frequency of the radar.

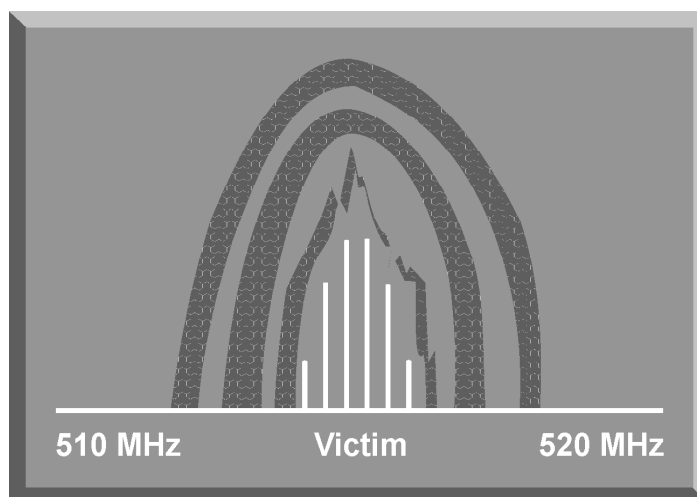

Figure 10-7. Spot Jamming

a. The primary advantage of spot jamming is its power density. Radar or communications receivers can be countered at longer ranges than when using a barrage jammer of equal output power (Figure 10-8).

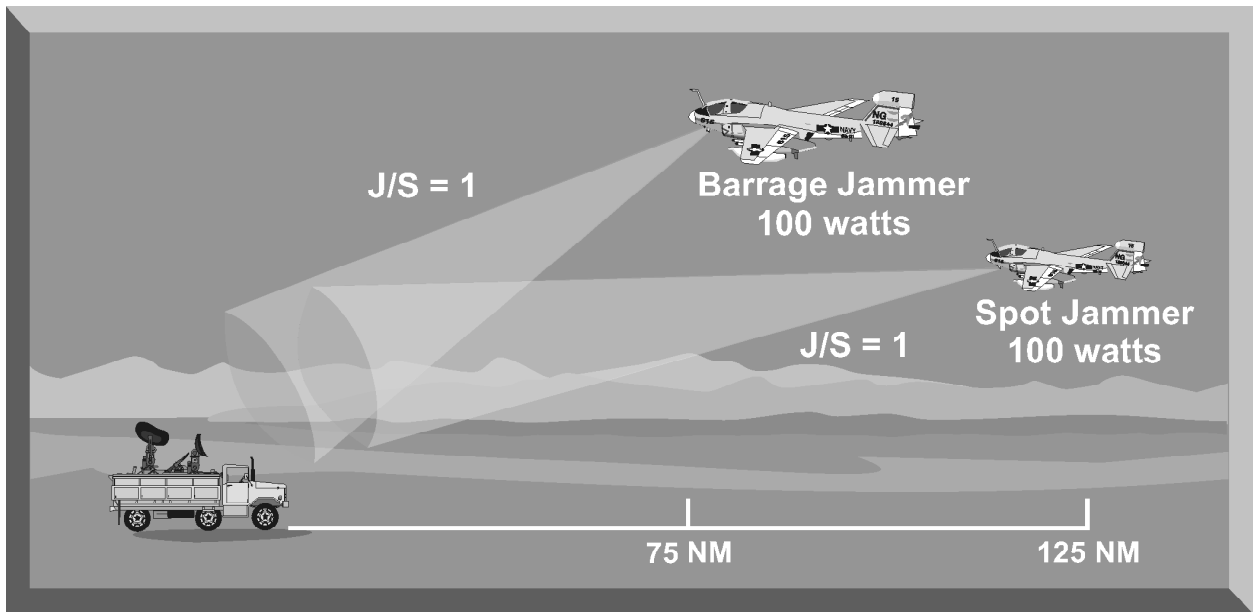

Figure 10-8. Spot Jamming Effectiveness

b. A disadvantage of the spot jammer is its coverage of a narrow band of the frequency spectrum. An operator or computer in the receiver must constantly monitor and tune the jamming signal to the target radar's frequency. The complexity of this process increases when jamming frequency-agile radars that can change frequencies with every pulse.

6. SWEEPED-SPOT JAMMING

When high power density is required over a large bandwidth, one solution is to take spot jamming and sweep it across a wide frequency range (Figure 10-9). This preserves the high power density but allows the jamming to cover a large bandwidth. The jamming spot is swept across a broad frequency range at varying speeds. With this technique, a number of radar systems can be covered. Because of their high jamming power, swept-spot jammers are able to cover a number of radars operating in a broad frequency range. However, jamming is not continuous. Fast swept-spot jamming can approximate continuous jamming by causing a phenomenon known as “ringing.” Fast sweeping spot noise is like a burst of energy which sets up vibrations within the receiver section. When these vibrations last until the next burst of energy is received, this is known as ringing. Three factors determine swept-spot jamming effectiveness. The first is the power in the spot. The next is the bandwidth, or frequency range, the spot covers. The last is the sweep rate.

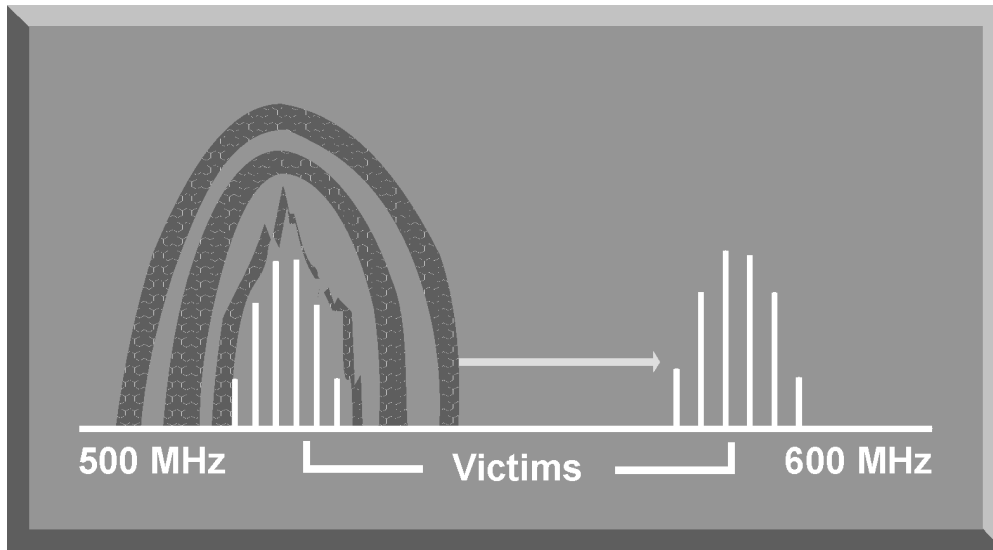

Figure 10-9. Swept-Spot Jamming

7. COVER PULSE JAMMING

Cover pulse jamming is a modification of swept-spot jamming. This is a “smart noise” technique that is responsive for a short period of time (Figure 10-10). A repeater jammer acts as a transponder. It receives several radar pulses and determines the PRF of the victim radar. It then uses this data to predict when the next radar pulse should arrive. Using an oscillator that is gated for a period of time based on predicted pulse arrival time, a noise-modulated signal is amplified and transmitted. This process works against a radar with a steady PRF, and allows a low-powered repeater to respond to a number of threats by time-sharing.

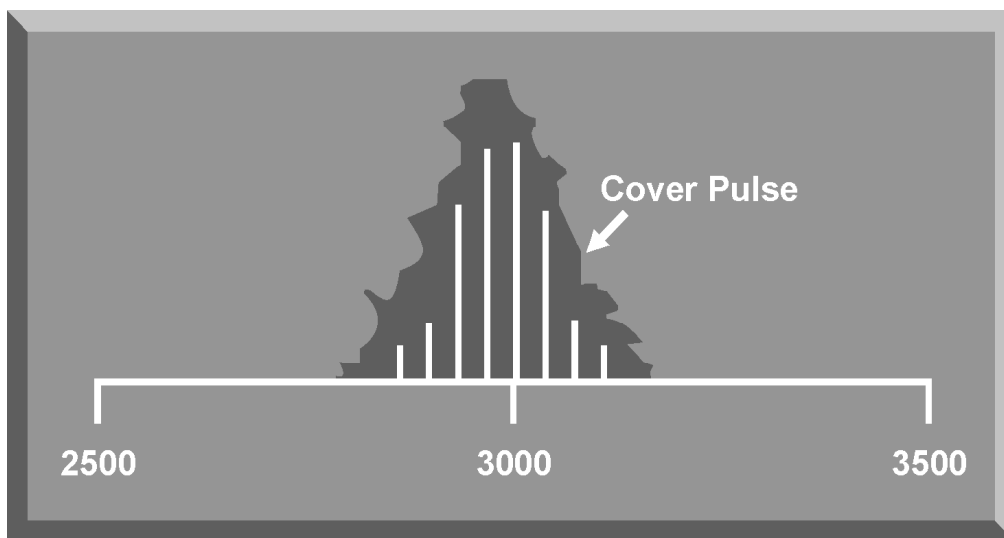

Figure 10-10. Cover Pulse Jamming

a. Cover pulse jamming is used to initiate a range gate pull-off (RGPO) deception jamming technique. The deception jammer transmits a noise jamming signal, or cover pulse, that is much stronger than the target return. The cover pulse raises the automatic gain inside the range gate, and the range tracking loop initiates tracking on the cover pulse. The deception jammer then increases the time delay in the jamming pulse and moves the range tracking gate away from the real target (Figure 10-11).

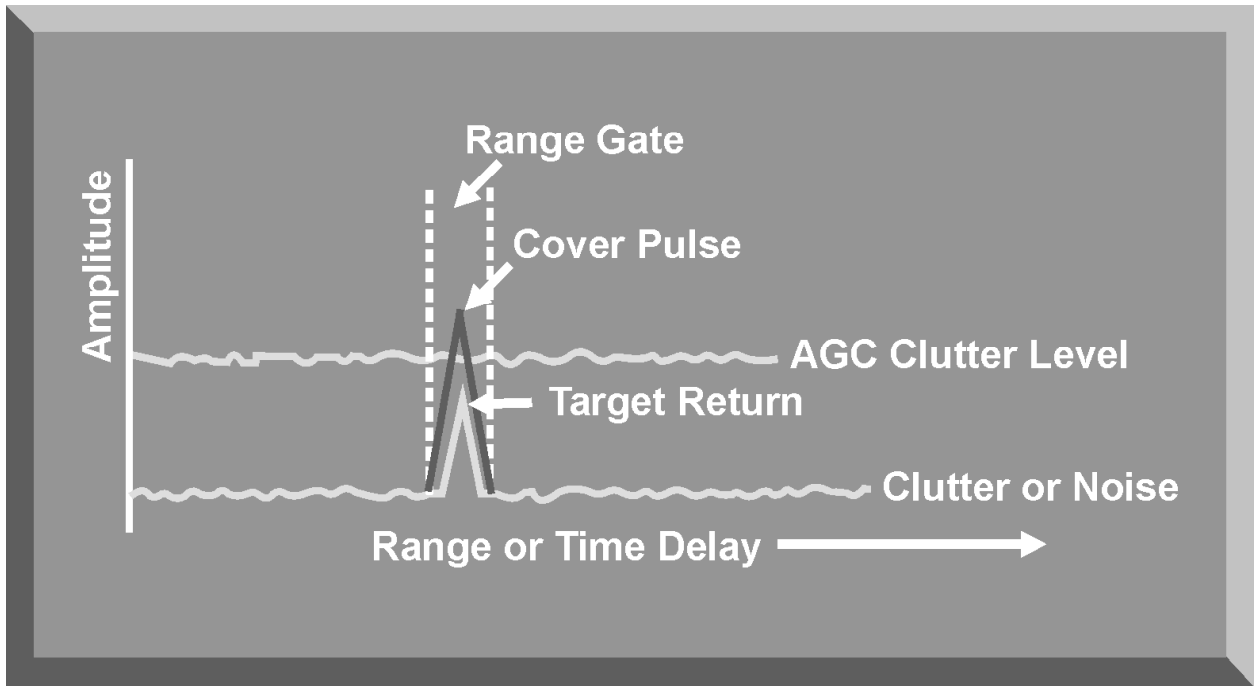

Figure 10-11. Range Gate Pull-Off Cover Pulse

b. A form of cover pulse jamming is also used to initiate a velocity gate pull-off (VGPO) technique against continuous wave and pulse Doppler radars. The cover pulse, in this case, is a strong jamming signal with the same frequency shift as the aircraft return. This cover pulse steals the velocity tracking gate and sets up the velocity tracking loop to steal the velocity tracking gate based on false target Doppler shifts (Figure 10-12).

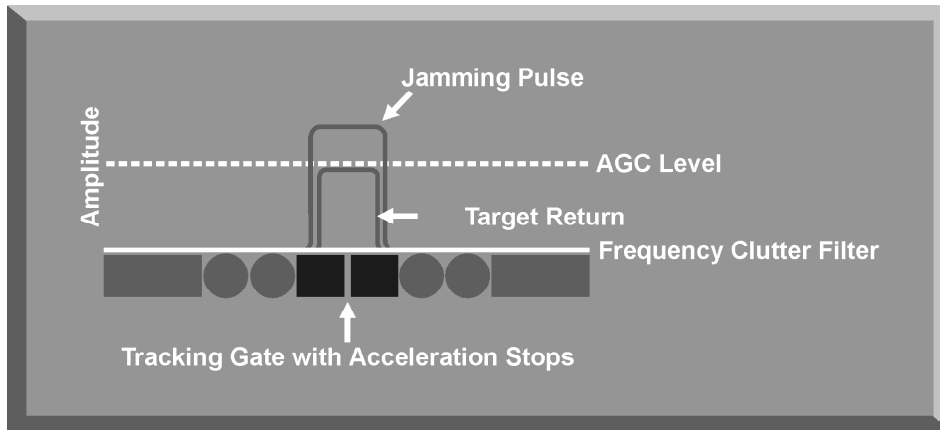

Figure 10-12. Velocity Gate Pull-Off Cover Pulse

8. MODULATED NOISE JAMMING

Modulated jammers are special hybrid jammers which employ noise jamming that is either amplitude or frequency modulated. The purpose of this modulated noise is to defeat target tracking radars (TTRs) rather than deny range information. Modulated noise jamming has proven effective against conical scan and track-while-scan (TWS) TTRs.

a. Modulated jamming alters the noise jamming signal at a frequency that is related to the scan rate of the target radar. If modulated jamming is used against a conical scan radar, a sine wave signal is used (Figure 10-13). The frequency of the sine wave is slightly higher than the scan rate of the victim radar. The amplitude difference results in a constantly varying phase between the radar and the jamming signal. This phase differential produces false targets with a strong signal amplitude everywhere the signals reinforce each other. This causes the conical scan radar to track the false returns and lose the real target return. For this technique to work, the scan rate of the intended victim radar must be known.

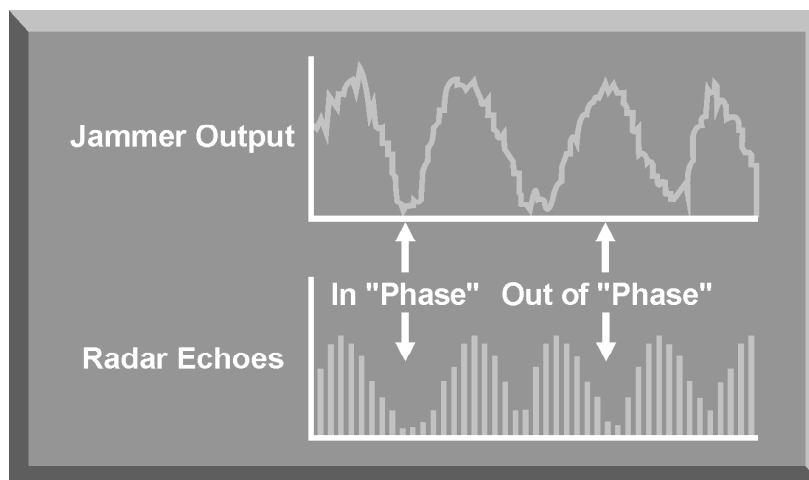

Figure 10-13. Conical Scan Modulated Jamming

b. Against a TWS radar, a rectangular waveform is used to modulate the noise signal. The PRF of the modulation is set at some harmonic of the TWS rate. This synchronization results in a number of jamming strobes on the radar scope. Each jamming strobe is at a different azimuth or elevation depending on which radar beam is being jammed. The number of jamming strobes depends directly on the harmonic used to modulate the signal. In Figure 10-14, a modulating signal frequency that is four times the scan rate of the radar will produce four jamming strobes on the scope. If the jamming is slightly out of tune with the scan rate, the jamming strobes will appear to roll across the radar scope.

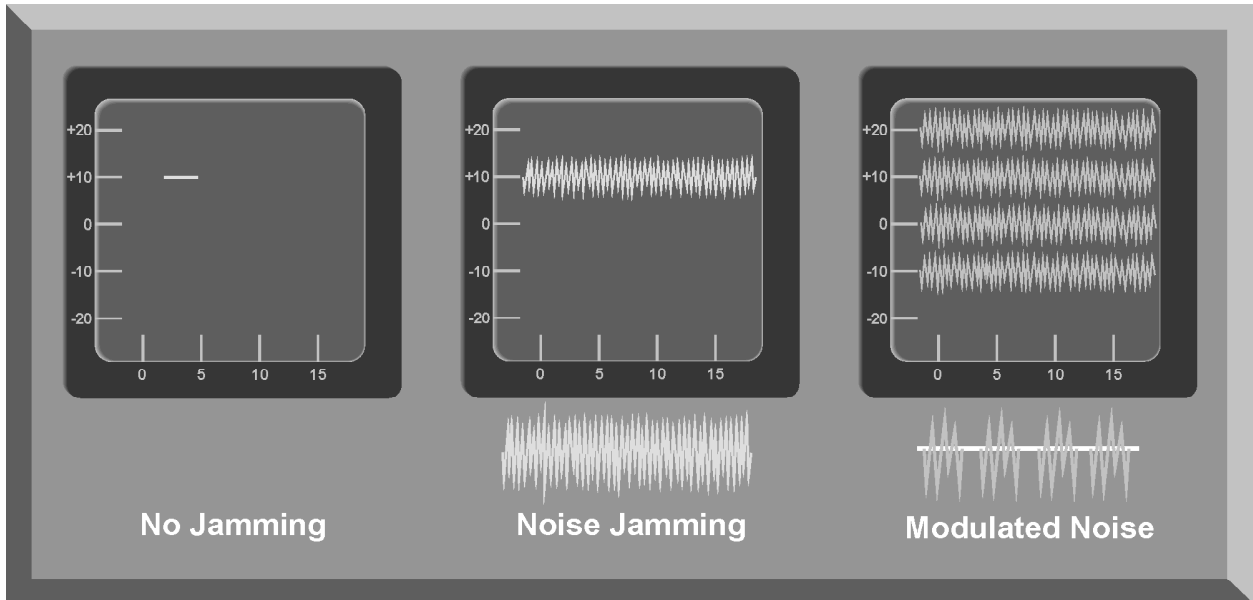

Figure 10-14. TWS Modulated Jamming

9. SUMMARY

Radar noise jamming is employed to deny target acquisition and target tracking data to a victim radar. This is accomplished by injecting amplitude or frequency modulated noise jamming signals into the victim radar's receiver. The radar noise jamming techniques discussed in this chapter included barrage, spot, swept-spot, cover pulse, and modulated jamming. The effectiveness of these noise jamming techniques depends on the power density of the jamming signal compared to the power in the radar return, or the J/S ratio. Radar noise jammers are generally simple, high-power systems which can be effectively employed in a support or self-protection role. Radar noise jamming can be employed in conjunction with deception jamming techniques to maximize the impact of jamming on victim radars.

CHAPTER 11. DECEPTION JAMMING

1. INTRODUCTION

Deception jamming systems are designed to inject false information into a victim radar to deny critical information on target azimuth, range, velocity, or a combination of these parameters. To be effective, a deception jammer receives the victim radar signal, modifies this signal, and retransmits this altered signal back to the victim radar. Because these systems retransmit, or repeat, a replica of the victim's radar signal, deception jammers are known as repeater jammers. The retransmitted signal must match all victim radar signal characteristics including frequency, pulse repetition frequency (PRF), pulse repetition interval (PRI), pulse width, and scan rate. However, the deception jammer does not have to replicate the power of the victim radar system.

a. A deception jammer requires significantly less power than a noise jamming system. The deception jammer gains this advantage by using a waveform that is identical to the waveform the radar's receiver is specifically designed to process. Therefore, the deception jammer can match its operating cycle to the operating cycle of the victim radar instead of using the 100% duty cycle required of a noise jammer. To be effective, a deception jammer's power requirements are dictated by the average power of a radar rather than the peak power required for a noise jammer. In addition, since the jammer waveform looks identical to the radar's waveform, it is processed like a real return. The jamming signal is amplified by the victim radar receiver, which increases its effectiveness. The reduced power required for effective deception jamming is particularly significant when designing and building self-protection jamming systems for tactical aircraft that penetrate a dense threat environment. Deception jamming systems can be smaller, lighter, and can jam more than one threat simultaneously. These characteristics give deception jammers a great advantage over noise jamming systems.

b. Although deception jammers require less power, they are much more complex than noise jammers (Figure 11-1). Memory is the most critical element of any deception jammer. The memory element must store the signal characteristics of the victim radar and pass these parameters to the control circuitry for processing. This must be done almost instantaneously for every signal that will be jammed. Any delay in the memory loop diminishes the effectiveness of the deception technique. Using digital RF memory (DRFM) reduces the time delay and enhances deception jammer effectiveness. Deception jamming employed in a self-protection role is designed to counter lethal radar systems. To be effective, deception jamming systems must be programmed with detailed and exact signal parameters for each lethal threat.

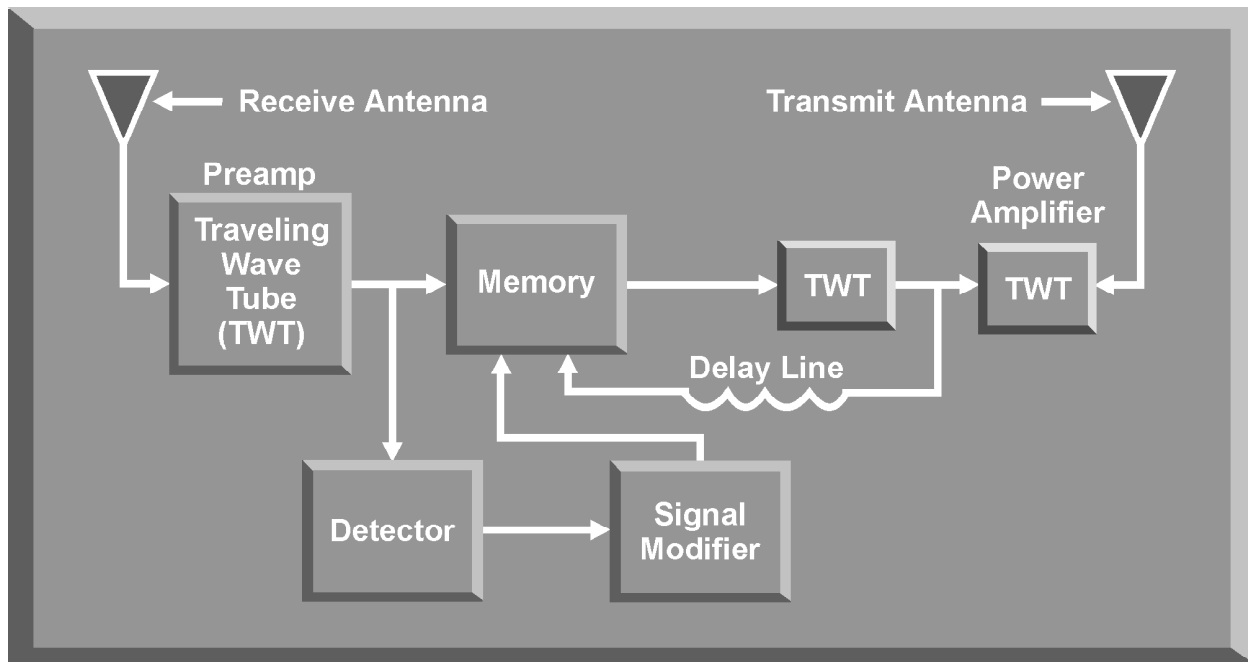

Figure 11-1. Deception Jamming System

c. The requirement for exact signal parameters increases the burden on electronic warfare support (ES) systems to provide and update threat information on operating frequency, PRF, PRI, power pulse width, scan rate, and other unique signal characteristics. An electronic intelligence (ELINT) architecture is required to collect, update, and provide changes to deception jamming systems. In addition, intelligence and engineering information on exactly how a specific threat system acquires, tracks and engages a target is essential in identifying system weaknesses. Once a weakness has been identified, an effective deception jamming technique can be developed and programmed into a deception jammer. For example, if a particular radar system relies primarily on Doppler tracking, a Doppler deception technique will greatly reduce its effectiveness. Threat system exploitation is the best source of detailed information on threat system capabilities and vulnerabilities. Effective deception jamming requires much more intelligence support than does noise jamming.

d. Most self-protection jamming techniques employ some form of deception against a target tracking radar (TTR). The purpose of a TTR is to continuously update target range, azimuth, and velocity. Target parameters are fed to a fire control computer that computes a future impact point for a weapon based on these parameters and the characteristics of the weapon being employed. The fire control computer is constantly updating this predicted impact point based on changes in target parameters. Deception jamming is designed to take advantage of any weaknesses in either target tracking or impact point calculation to maximize the miss distance of the weapon or to prevent automatic tracking. This chapter will discuss the most commonly employed deception jamming

techniques, including false target jamming, range deception jamming, angle deception jamming, velocity deception jamming, and monopulse jamming.

2. FALSE TARGET JAMMING

False target jamming is an effective jamming technique employed against acquisition, early warning, and ground control intercept (GCI) radars. The purpose of this type of jamming is to confuse the enemy radar operator by generating many false target returns on the victim radar scope. When false target deception jamming is successfully employed, the radar operator cannot distinguish between false targets and real targets (Figure 11-2).

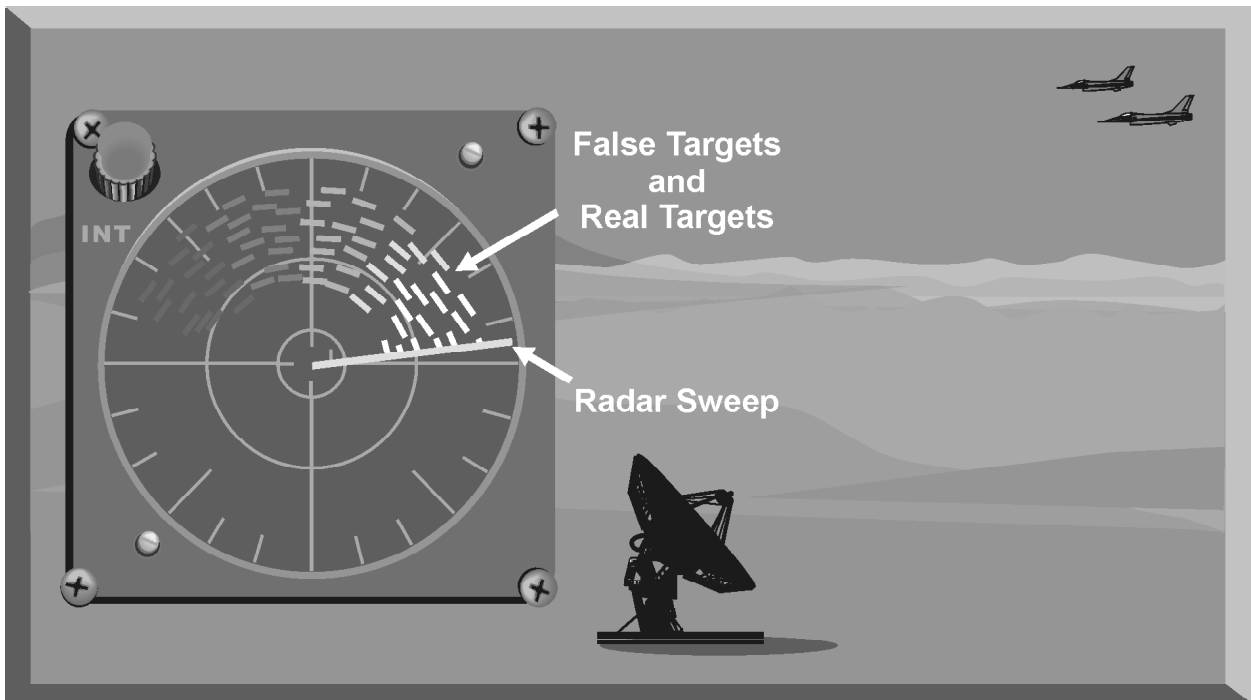

Figure 11-2. False Target Generation

a. To generate false targets, the deception jammer must tune to the frequency, PRF, and scan rate of the victim radar. The jamming pulse must appear on the radar scope exactly like a radar return from an aircraft. Multiple false targets greater in range than the jammer are generated by delaying the transmission of a jamming pulse until after the victim radar pulse has been received. False targets closer in range are generated by anticipating the arrival of a radar pulse and transmitting a jamming pulse before the victim radar pulse hits the aircraft. If the victim radar employs a jittered PRF, only targets greater in range can be generated.

b. To generate different azimuth false targets, the deception jammer synchronizes its transmitted pulse with the victim radar's sidelobes. Due to their

reduced power, when compared to the main beam, sidelobes are difficult to detect and analyze. The receiver in the deception jammer must be sensitive enough to detect these sidelobes and not be saturated by the power in the main radar beam. A false target deception jammer must inject a jamming pulse that looks like a target return into these sidelobes. To penetrate the radar sidelobes requires a lot of power. However, the power must be judiciously used. If a powerful jamming pulse is injected into the main beam, the false targets will be easy to detect. Most false target jammers vary the power in the jamming pulse inversely with the power in the received signal, on a pulse-by-pulse basis. This means the repeater jamming signal is at minimum power when the main beam of the victim radar is on the aircraft and at maximum power when the sidelobes are being jammed. To effectively generate false azimuth targets, the jammer must have a receiver with a wide dynamic range to detect both the main beam and the sidelobes. In addition, the jamming system must be able to generate high power that can be effectively controlled by the receiver.

c. To generate moving false targets, the deception jammer must synchronize with the main beam and the sidelobes in frequency, pulse width and PRF. Amplitude modulated jamming signals, with variable time delays, are transmitted into the sidelobes of the victim radar. The variable time delay provides a false target that changes range, either toward or away from the radar, depending on the time delay. The amplitude modulation provides false azimuth targets that appear to be moving.

d. The effectiveness of false target generation is based on the credibility of the generated false radar returns. If the victim radar can easily distinguish between false returns and target returns, the technique is a failure. The false returns must look identical to an aircraft return. The radar return on the victim radar scope should have the same intensity, depth, and width as a target return.

(1) Power determines the false target intensity when it is displayed on the victim radar scope. Varying jammer output power inversely with received power ensures that each false target has nearly the same intensity as a true target return. The depth, or thickness, of the false target depends on the pulse width of the victim radar. By matching the pulse width of the jamming pulse with the pulse width of the victim radar, the jammer can generate false targets with the same depth as a real target return.

(2) The width of the false target depends on the antenna pattern of the victim radar. This can pose a problem for false-target deception jammers. Because the jamming pulse is transmitted the entire time the radar beam is on the jammer, the width of a false target will tend to be greater than a real target return. Aircraft radar return varies with main beam cross-section. To correct this problem, most false target deception jammers use random modulation in the power of the transmitted pulses. This will vary the width of the false targets and make them look more like the variable returns of actual targets.

3. RANGE DECEPTION JAMMING

Although a specific TTR can track multiple targets and direct multiple weapons, the tracking circuit must select a single target return and track it while ignoring all other returns. Target selection is done by using gate bins. The range gate is used as the primary gate for target selection. A range gate is an electronic switch that is turned on for a period of microseconds based on a certain range or time delay after a pulse is transmitted (Figure 11-3).

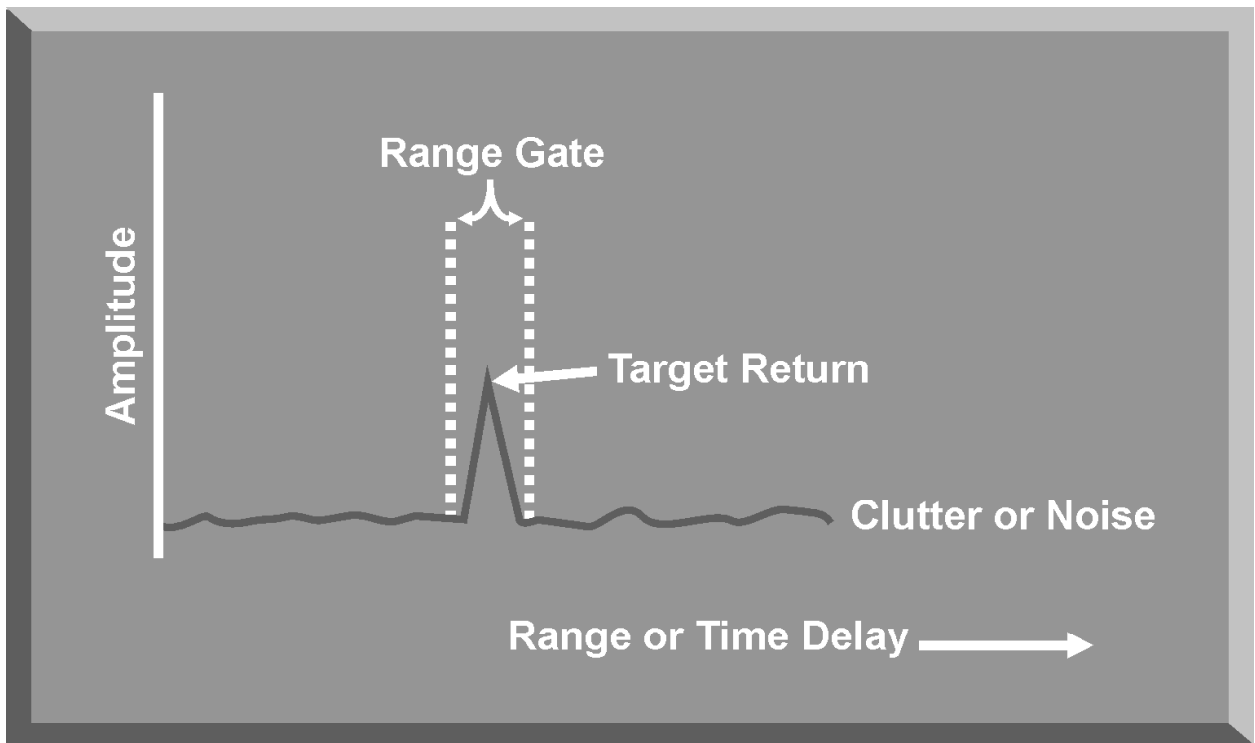

Figure 11-3. Range Gate Tracking

a. Range deception jamming exploits any inherent weakness in a TTR's automatic range gate tracking circuits. When a TTR's range gate locks on to an aircraft, the range deception jammer detects the radar signal. The range deception jammer then amplifies and retransmits a signal much stronger than the radar return. This retransmitted signal, called a cover pulse, is displayed in the range gate with the target signal (Figure 11-4).

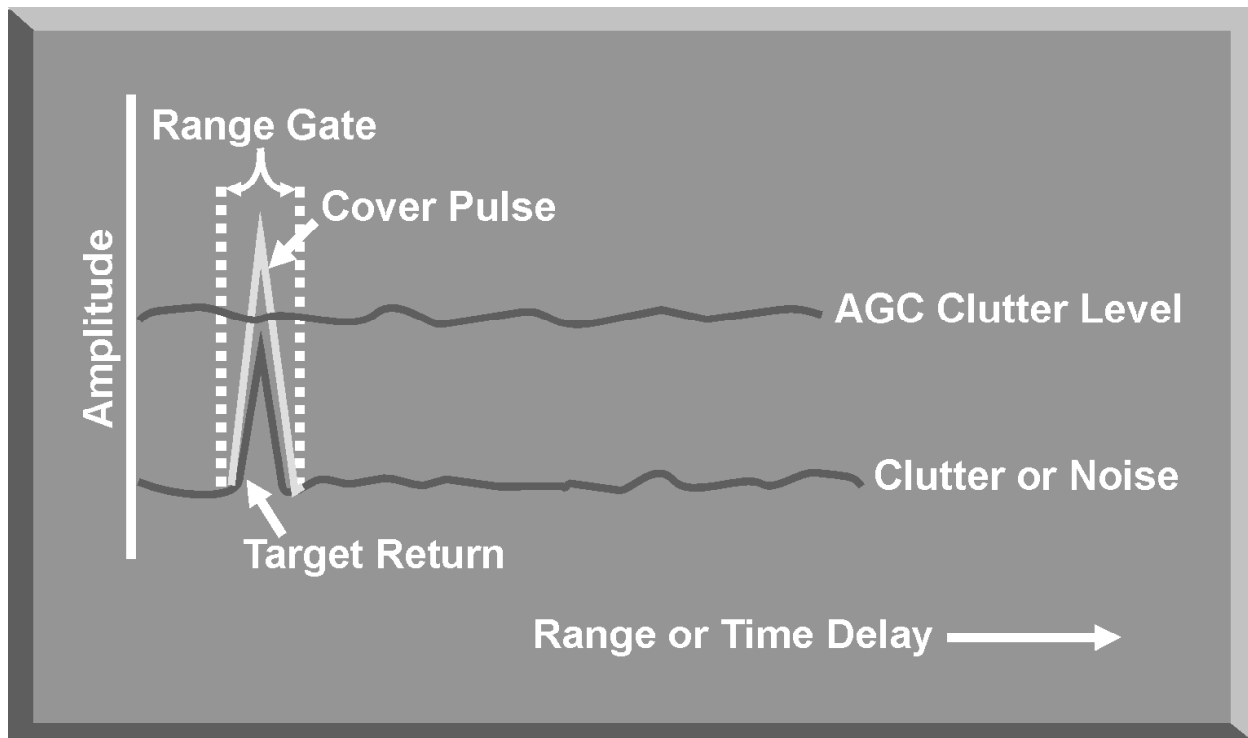

Figure 11-4. Range Gate Jamming Cover Pulse

b. The automatic gain control (AGC) circuit lowers the gain in the range tracking gate to control the amplitude of the cover pulse in the range gate. Reduced gain causes the real target return to be lost, and the range gate only tracks the jamming signal. This is known as range gate capture.

c. Once the range gate is captured by the cover pulse, a technique called range gate pull-off (RGPO) is employed (Figure 11-5). The deception jammer memorizes the radar signal and introduces a series of time delays before retransmitting. By increasing these time delays, the range gate will detect an increase in range and automatically move off to a false range. Once the range gate has moved well away from the real target, the range deception jammer shuts down, and the radar range gate is left with no target to track. The range gate breaks lock and the TTR must again go through the process of search, acquisition, and lock-on to re-engage the target.

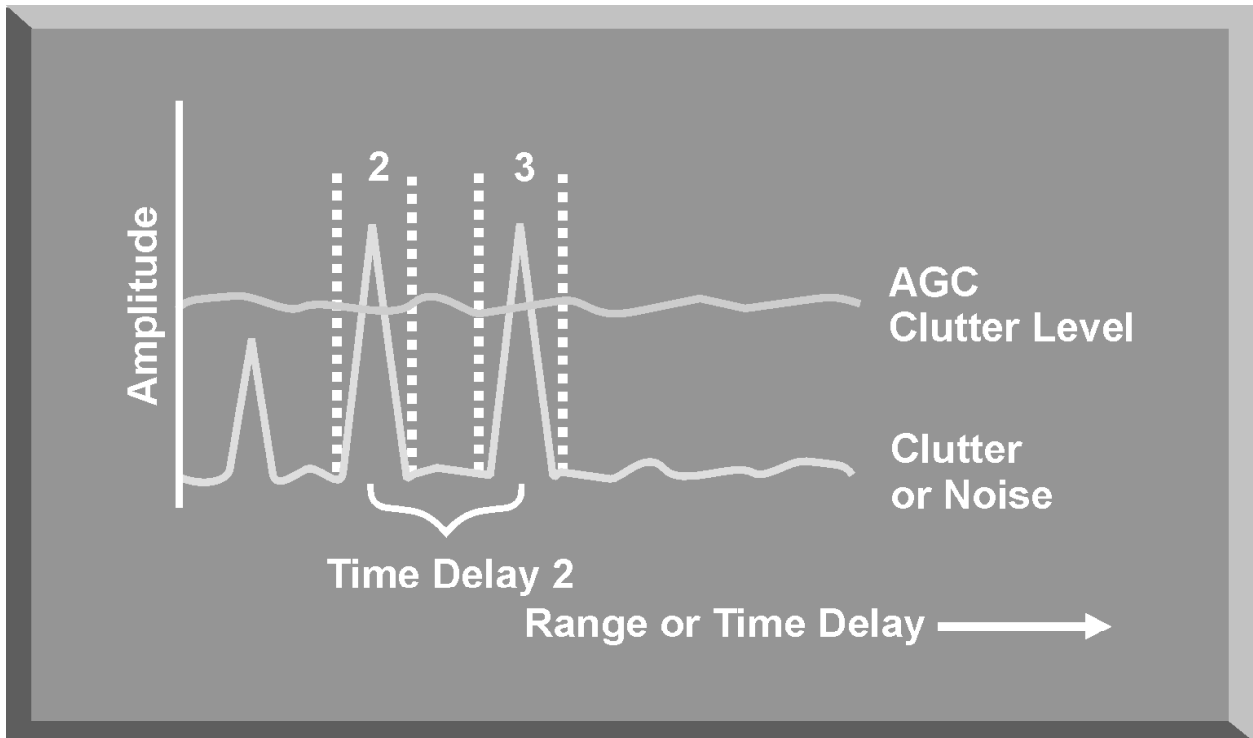

Figure 11-5. Range Gate Pull-Off

d. There are several advantages of range deception jamming, especially when used as a self-protection technique. It can generate sufficient errors to deny range information and is effective against most automatic range tracking systems. This technique does not require a large amount of power, just enough to cover the radar return of the aircraft. If the time delays are not exaggerated, an operator may not detect the loss of range lock-on until after a missile has been fired. The insidious nature of range deception jamming may generate enough miss distance to save the aircraft and pilot.

e. There are disadvantages to using range deception jamming. First, it can be defeated by a trained radar operator. If the operator detects a problem with the automatic range tracking circuit, the system can be switched to manual range tracking mode to defeat RGPO. Also, if the threat system is still able to track the aircraft's azimuth and elevation, range information may not be required to complete target engagement. To maximize range deception jamming effectiveness, it should be employed in conjunction with azimuth and elevation jamming. Finally, this type of range deception jamming is not effective against a leading-edge range tracking system. A leading-edge tracker will not see the delayed cover pulse. As the cover pulse moves off the target, AGC circuits reset the gain to continue tracking the real target. The only way to defeat a leading-edge range tracker is with a deceptive jammer that anticipates the next radar pulse and sends a jamming cover pulse before it reaches the aircraft. This jamming technique can also be defeated by randomly varying the radar PRF.

4. ANGLE DECEPTION JAMMING

Angle deception jamming is designed to exploit weaknesses in the angle tracking loop of the victim radar. The specific technique depends on the tracking method used to derive azimuth and elevation information. Inverse amplitude modulation jamming is the main angle deception technique used against TWS radars. For conical scan radars, scan rate modulation and inverse gain jamming are used. Swept square wave (SSW) jamming is used against LORO tracking radars. Monopulse angle deception jamming will be covered separately.

a. The azimuth and elevation tracking loop for a TWS radar is based on target signal amplitude modulation. The inverse amplitude modulation jammer generates a signal with modulation exactly opposite the expected return. To accomplish this, the angle deception jammer must receive the radar signals from the tracking beams. The jammer responds with a signal of the same frequency, PRF, and scan rate synchronized to the inverse of the radar antenna pattern (Figure 11-6). This induces an error in the angle tracking gate that, over a series of scans, causes the radar to lose target angle tracking.

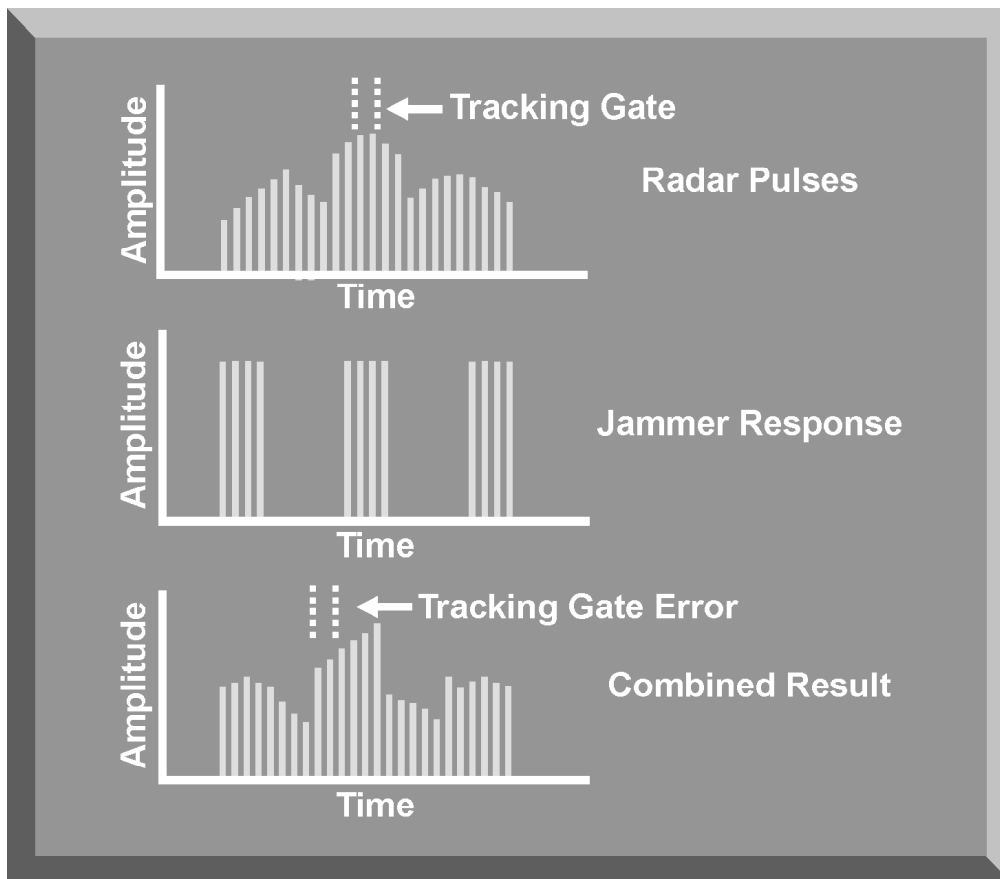

Figure 11-6. Inverse Amplitude Modulation Jamming

b. Inverse gain jamming is also effective against conical scan radars. Since conical scan radars use the phase of the target returns to generate error signals, an inverse gain deception jammer attempts to alter the phase by inducing fake signals into the antennas. In addition, by altering the amplitude of the signal, the jammer induces large errors into the tracking loop. To accomplish this, the jammer must determine the frequency, PRF, and scan rate of the victim radar. It then transmits signals that change the phase and amplitude of the target signal, resulting in a signal 180 degrees out of phase with the actual target (Figure 11-7). This 180-degree error rapidly drives the antenna off the target and causes break-lock.

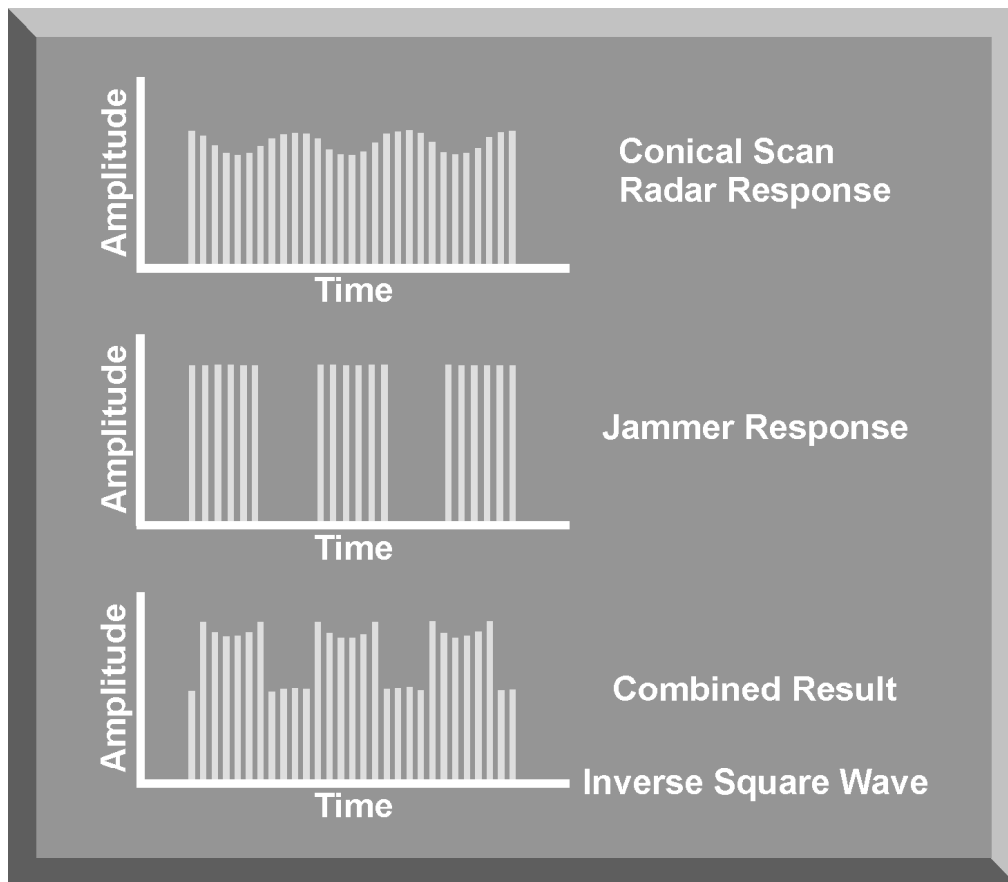

Figure 11-7. Inverse Gain Jamming

c. Scan rate modulation is also used against conical scan radars. This angle deception technique modulates the jamming pulse at or near the victim radar nutation frequency. As the modulation approaches the radar's nutation frequency, large error signals appear in the radar servo tracking loops, producing random gyrations in the antenna system, causing break-lock. This technique is most effective if the modulation jamming is slowly swept in frequency until it matches the nutation rate.

d. Both inverse scan and scan rate modulation jamming require very little power and have proven extremely effective against TWS and conical scan radars. To be effective, however, the angle deception jammer must find the precise scan rate of the victim radar. The jammer must concentrate on one signal at a time, limiting the number of threat systems that can be jammed simultaneously. In a dense threat environment, this can be a severe limitation.

e. The effectiveness of inverse gain and scan rate modulation jamming led radar designers to employ antennas that scan only during the receiving function of the radar system. Generally, this is accomplished by using two antennas. The transmitting antenna illuminates the target. Receiving antennas scan to produce the amplitude modulation of the reflected signal for effective angle tracking. This technique is called Lobe-On-Receive-Only (LORO). Since the transmitting antenna does not nutate, or scan, angle deception jammers cannot detect the modulation required to generate effective inverse gain modulation. Swept square wave (SSW) jamming is the angle deception technique developed to counter LORO angle tracking.

f. SSW jamming continuously varies the frequency of amplitude modulation on the jamming pulse over an expected range of nutation or scanning frequencies. This range is established by either electronic intelligence (ELINT) data on a particular system, or by exploitation. The dotted line in Figure 11-8 shows a threat's nutation or scan frequency. As the frequency of the modulated jamming pulse approaches the threat scan frequency, it induces errors in the angle tracking loop of the victim radar. The longer the SSW jamming stays near the scan frequency, the greater the induced errors. It is important that the sweep rate of the modulating jamming be slow enough to maximize its impact on the victim radar.

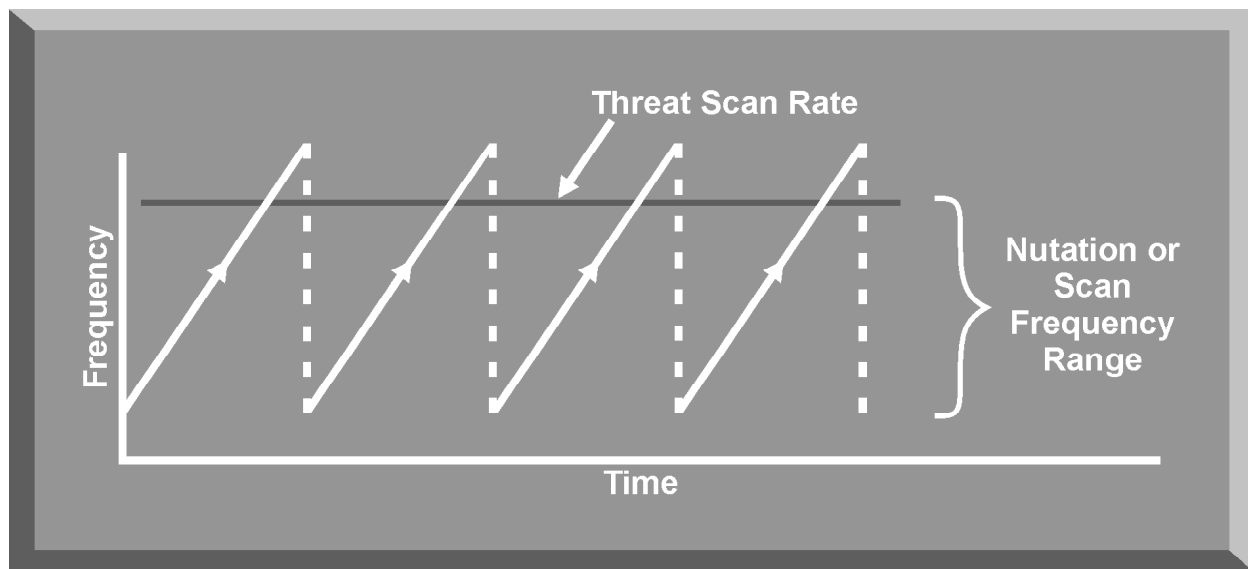

Figure 11-8. Swept Square Wave Jamming

5. VELOCITY DECEPTION JAMMING

Pulse Doppler and continuous wave (CW) radars track targets based on velocity or Doppler-shifted frequency (Figure 11-9). The objective of velocity deception jamming is to deny velocity tracking information and generate false velocity targets. The primary techniques include velocity gate pull-off (VGPO), Doppler noise, narrowband Doppler noise, and Doppler false targets.

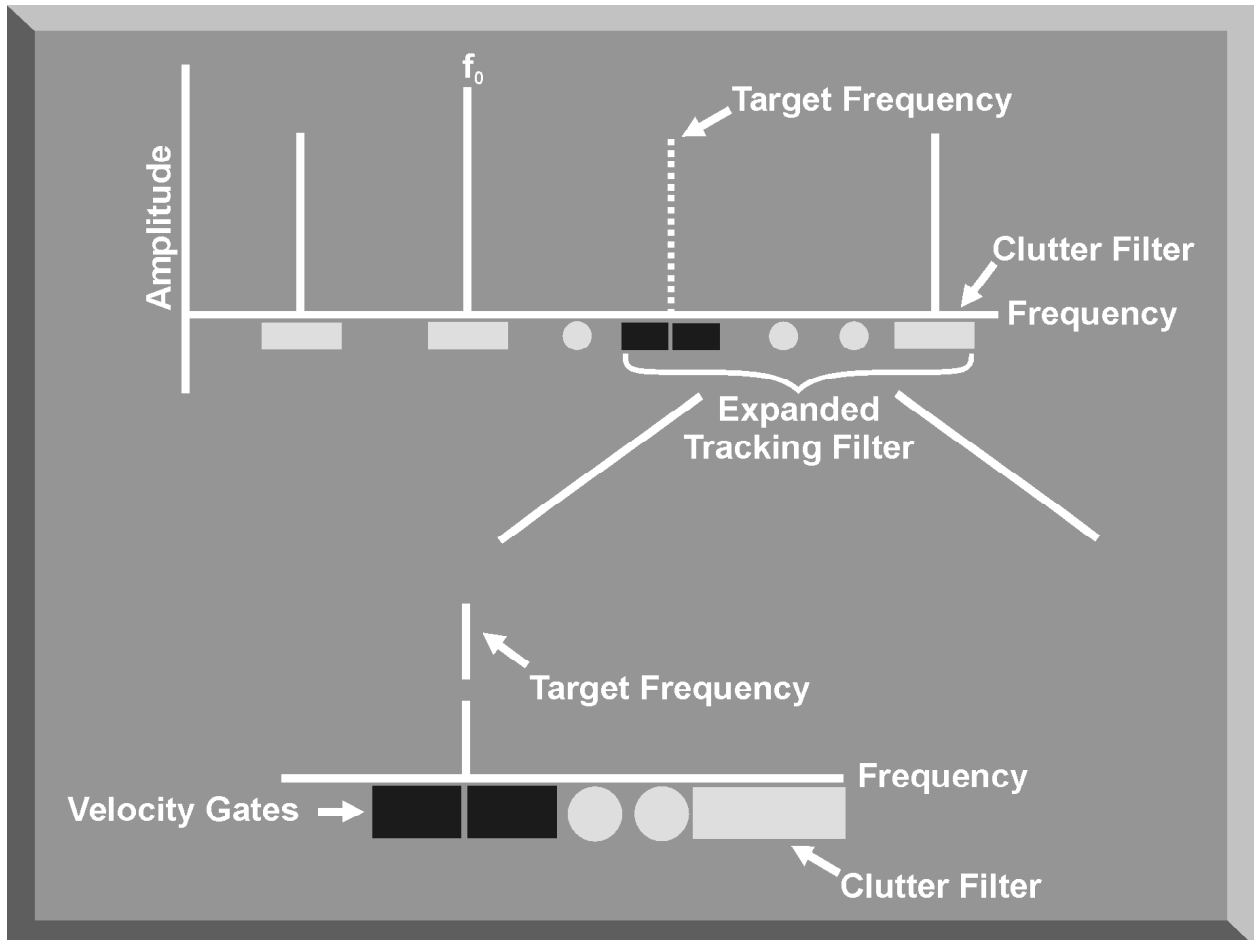

Figure 11-9. Velocity Tracking Gate

a. Velocity gate pull-off counters pulse Doppler or CW radars by stealing the velocity gate of their automatic tracking loop. The objective of VGPO is to capture the Doppler velocity tracking gate by transmitting an intense false Doppler signal. Then the frequency of the false signal is changed to move the tracking gate away from the true target Doppler. This is analogous to the RGPO technique used against the range gate tracking loop.

(1) To accomplish an effective VGPO technique, the jammer receives the CW or pulse Doppler signal. It then retransmits a CW or pulse Doppler signal that is higher in power than the return from the aircraft, but at approximately the same

Doppler frequency (Figure 11-10). It is important that the frequency of this initial jamming pulse appears within the same velocity tracking filters as the target return or the victim radar will disregard it. The frequency band of the Doppler tracking filters is an important piece of intelligence information. The velocity tracking gates are quite narrow, roughly 50 to 250 MHz. Once the jamming pulse appears in the tracking gate, the automatic gain control circuit gains out the target return, and the jamming pulse has captured the velocity gate.

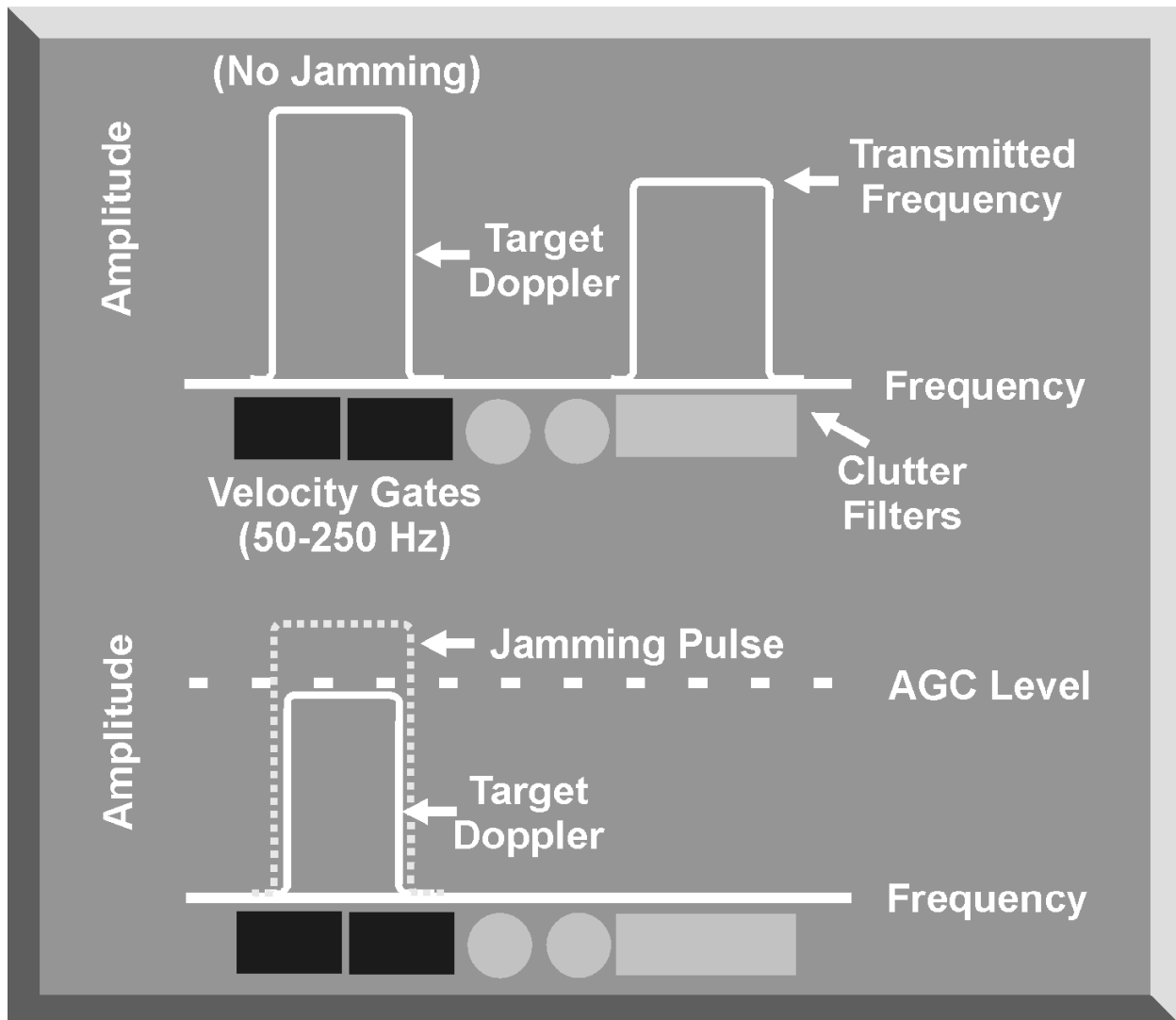

Figure 11-10. Velocity Gate Capture

(2) Once the jamming pulse has captured the tracking gate, the deception jammer slowly changes the Doppler frequency (Figure 11-11). This frequency shift is accomplished by several methods. The most common method uses frequency modulation (FM) within the jammer's traveling wave tube (TWT). By varying the TWT voltage, the Doppler frequency of the jamming pulse is changed

linearly, and the radar tracking gates follow the jamming pulse. By using FM, the jamming pulse can be moved in either a positive or negative direction, depending on the slope of the voltage. By slowly changing the frequency of the modulation, the jamming pulse pulls the tracking gates off the target. When the maximum offset has been achieved, nominally 5 to 50 kHz, the FM is “snapped back” to a minimum value, and the process is repeated to preclude target reacquisition.

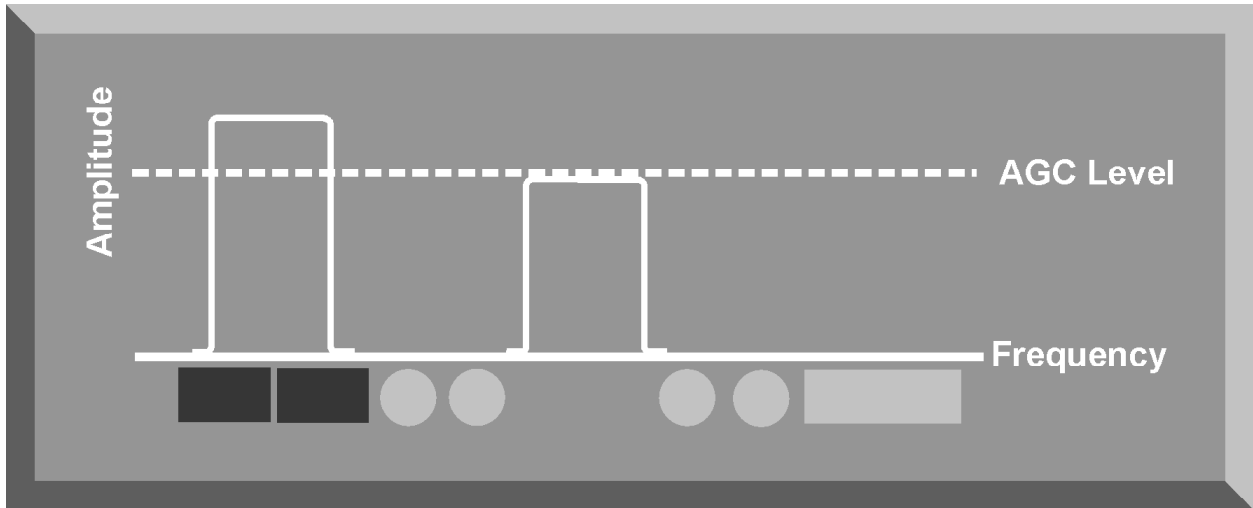

Figure 11-11. Velocity Gate Pull-Off

(3) The rate of change of frequency offset in a VGPO pulse is an extremely critical parameter. Many CW and pulse Doppler radars employ acceleration stops as part of the tracking gates. By differentiating the velocity outputs of the velocity tracking gates with respect to time, the velocity tracker computes target acceleration. Acceleration stops detect and reject unusually large changes in target acceleration. If the VGPO technique changes the frequency of the jamming pulse too rapidly, the tracking loop, with acceleration stops, will reject the jamming pulse and stay on the target. This means that an effective VGPO technique may take from one to ten seconds.

b. Doppler noise differs from most noise techniques in that it is a repeater technique. The jamming system must receive the pulse Doppler radar signal in order to generate an appropriate jamming pulse. Also, noise jamming output is done on a pulse-by-pulse basis and only lasts as long as the pulse duration, or pulse width, of the victim radar signal (Figure 11-12). The Doppler noise jammer receives each pulse and applies a random frequency shift, either positive or negative, to each pulse.

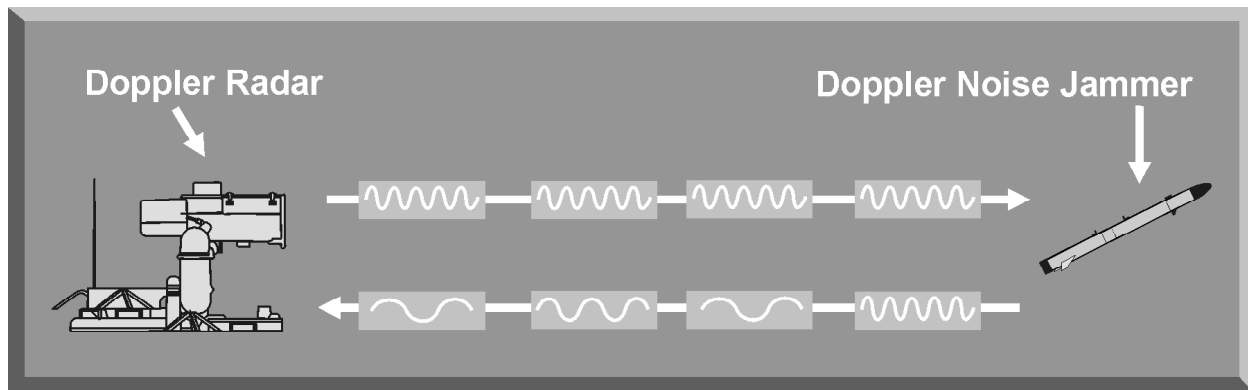

Figure 11-12. Doppler Noise Jamming

(1) When Doppler noise jamming pulses are processed by the signal processor, and the Doppler frequencies are sent to the velocity tracking gate, there are so many different velocities that the tracking gate cannot distinguish the target from the jamming. The random distribution of target velocities effectively masks the true target Doppler velocity. If the velocity tracking loop is not saturated, multiple false targets traveling at different speeds will be displayed.

(2) When a technique called Doppler noise blinking is employed, it interferes with the angle and velocity tracking within most semi-active radar missiles. Doppler noise blinking is accomplished by rapidly transmitting bursts of Doppler noise jamming (Figure 11-13).

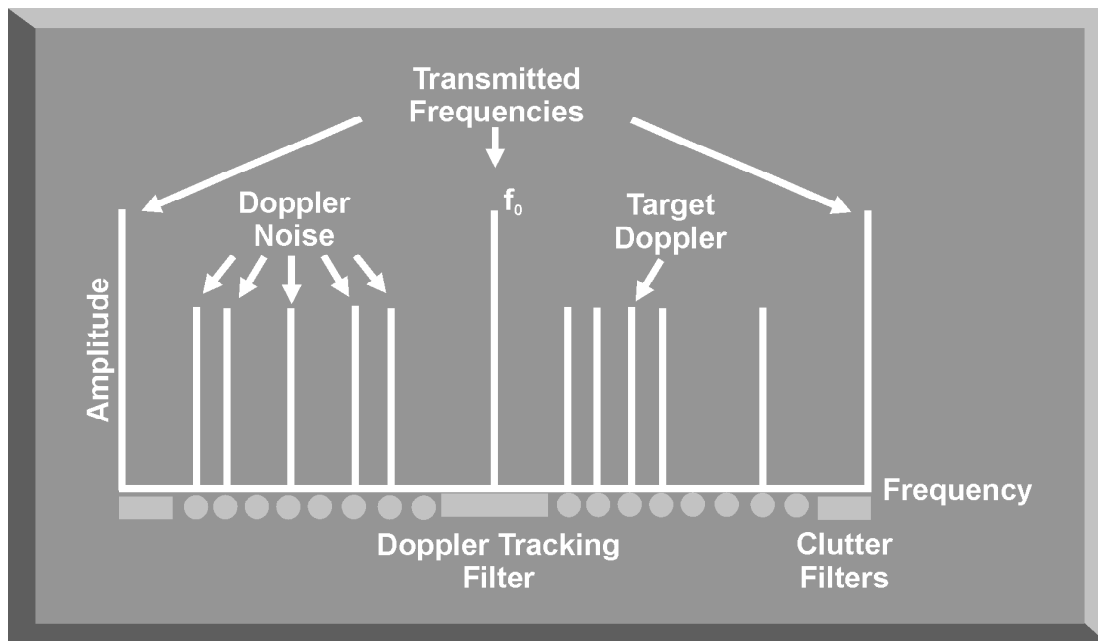

Figure 11-13. Impact of Doppler Noise Jamming

(3) Doppler noise jamming is effective against most pulse Doppler radars and the semi-active missiles employed with these radars. One disadvantage, however, is that it is only effective against the velocity tracking loop. If range tracking is still available to the radar, Doppler noise may highlight the jamming aircraft. Another disadvantage is that Doppler noise requires a sophisticated jammer able to receive the victim radar pulse, generate random positive and negative frequency modulations on this pulse, and retransmit the jamming pulses at the PRF and pulse width of the victim radar. This requires an extremely fast signal processing capability and detailed intelligence information on the victim radar.

c. Narrowband Doppler noise is also a repeater technique. The jamming system receives the pulse Doppler radar signal and generates a noise jamming signal on a pulse-by-pulse basis (Figure 11-14). Narrowband Doppler noise requires detailed information on the frequency coverage of an individual velocity tracking filter, or velocity bin, employed by the victim radar. Once this frequency range is known, the jammer receives each pulse from the victim radar and transmits jamming pulses with a higher and lower frequency shift based on the real target Doppler. These frequency shifts are always within the frequency range of the velocity bin.

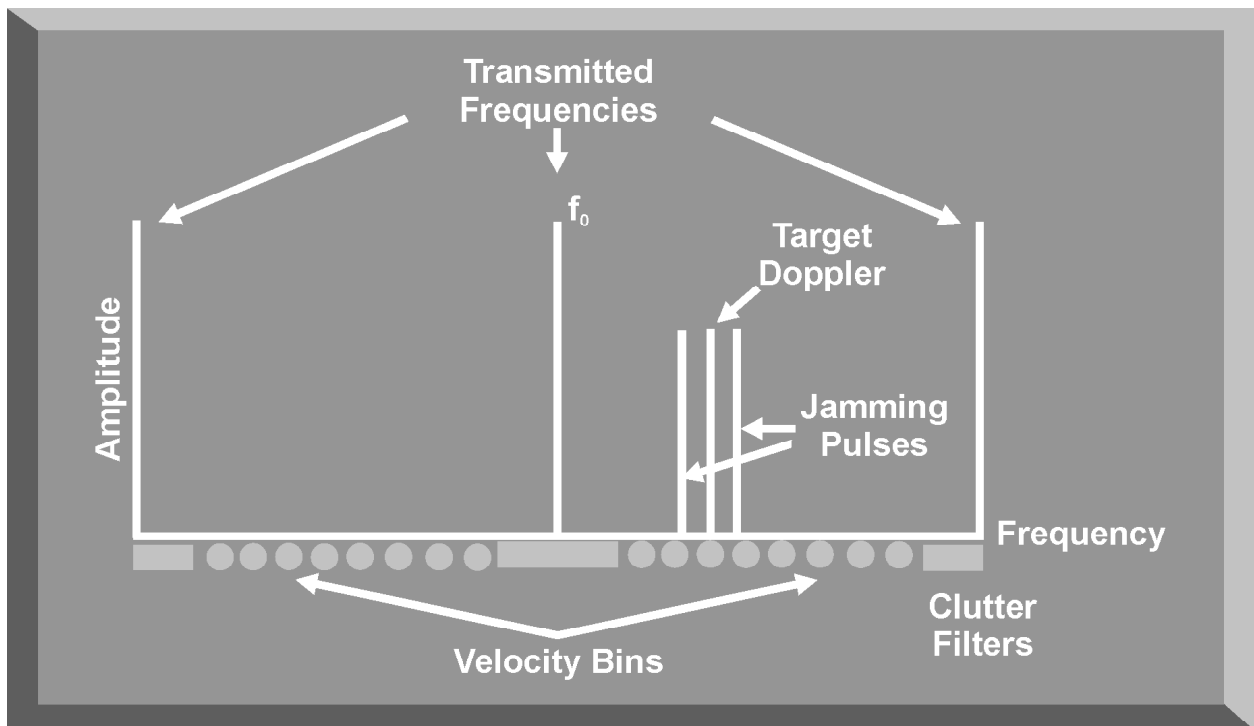

Figure 11-14. Narrowband Doppler Noise

(1) When these pulses are processed by the signal processor and the Doppler signals are sent to the velocity tracking gates, the particular bin that

contains the target Doppler also contains several other targets generated by the jammer. The victim radar signal processor attempts to distinguish the target Doppler from the jamming pulses. It raises the gain in the velocity tracking bins, thinking that the signal with the highest amplitude is the target. But, as the signal gain is increased, the target is “gained out” with the jamming signals and no target is displayed. This is called velocity bin masking and can completely deny target information to a pulse Doppler radar (Figure 11-15).

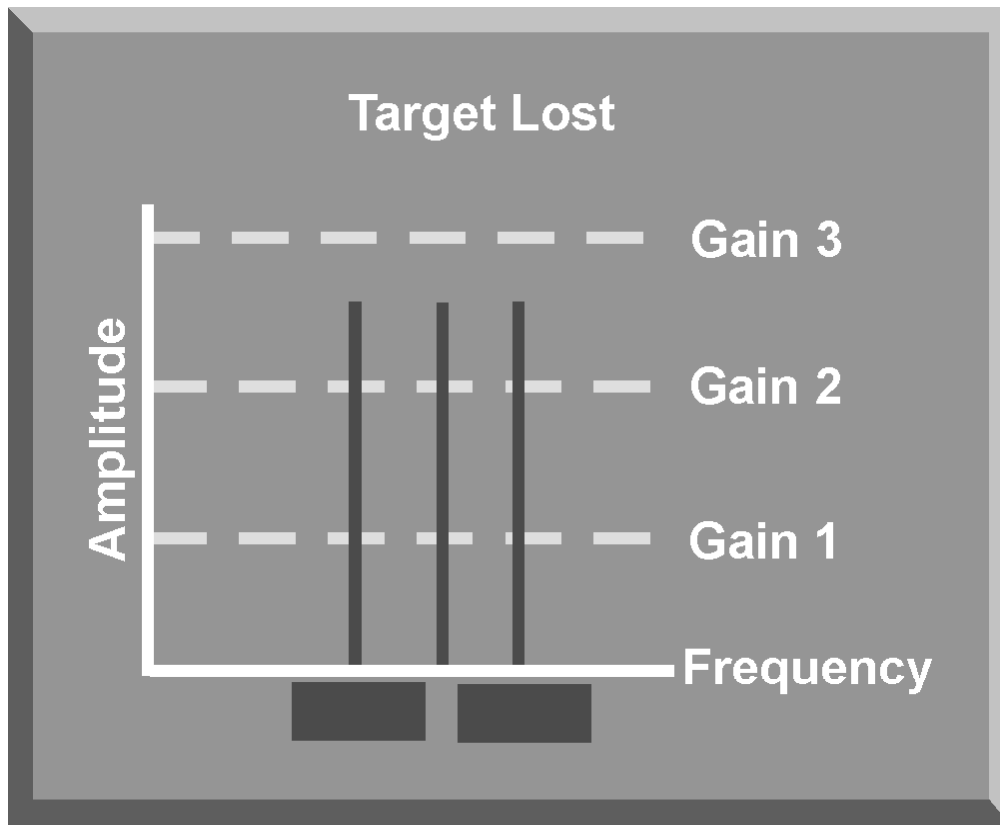

Figure 11-15. Velocity Bin Masking

(2) The advantage of narrowband Doppler noise is that it completely masks an aircraft's velocity from a pulse Doppler radar. The disadvantages include the following: When the victim radar can range-track an aircraft, narrowband Doppler noise highlights the aircraft's presence. To be effective, narrowband Doppler noise requires knowledge of the frequency range of the victim radar's velocity tracking bins, or filters. This detailed information may be available only through threat system exploitation. Finally, sophisticated signal processing and jamming systems are required to receive and transmit in the very narrow frequency band of the velocity bin.

d. Doppler false target jamming is normally used with narrowband Doppler noise or other deception techniques. Its purpose is to initially confuse the radar signal processor with multiple targets and then force the radar signal processor

to raise its gain levels in the velocity tracking loop. The Doppler false target jammer receives each pulse of the victim radar and applies a random frequency shift to a selected number of these pulses (Figure 11-16).

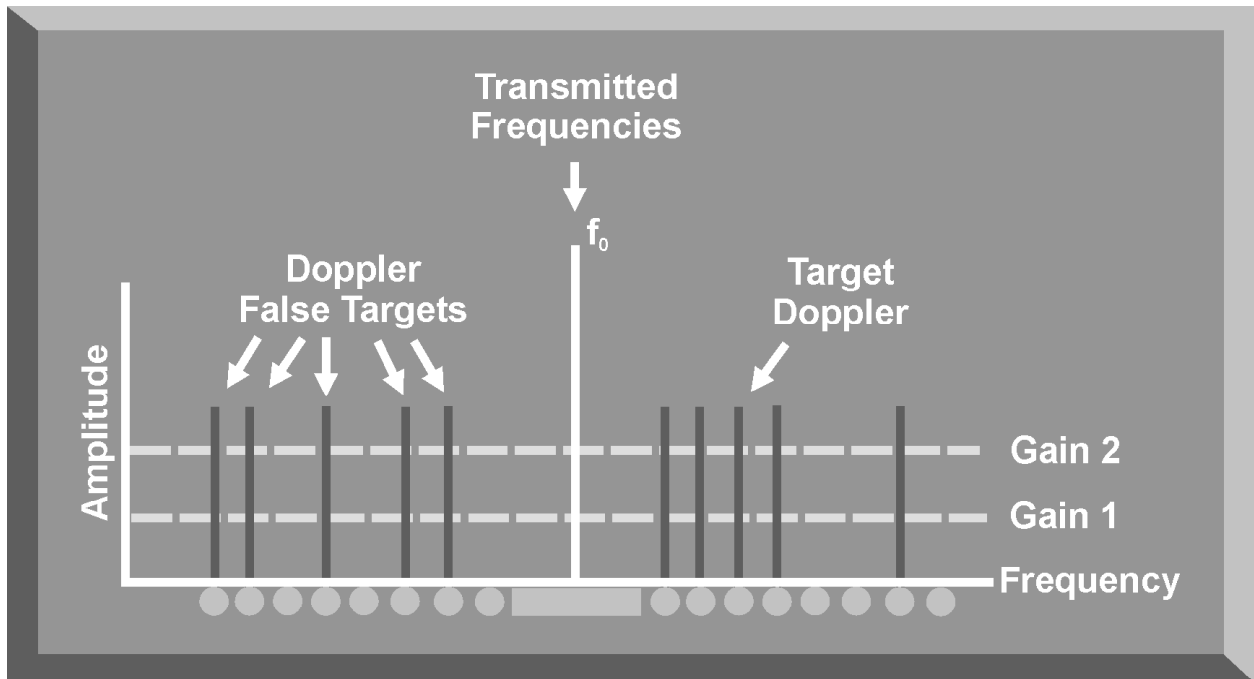

Figure 11-16. Impact of Doppler False Target Jamming

(1) The selected pulses are processed by the signal processor, and multiple Doppler frequencies are sent to the velocity tracking gate. In an attempt to distinguish the target from the jamming pulses, the signal processor increases the gain in each tracking filter, assuming the target Doppler has a higher amplitude than the jamming pulses. This increase in gain sets up the velocity tracking loop for a narrowband Doppler noise technique that will cause the real target to be lost among the generated false targets.

(2) The advantage of Doppler false target jamming is that it can initially confuse the radar signal processor and the radar operator as to the velocity of the real target. It also sets up the radar for narrowband Doppler noise technique and increases its effectiveness. The disadvantage is that the signal processor or the radar operator will eventually be able to distinguish the real target from the false targets based on its velocity. This jamming technique is much more effective when used in conjunction with other Doppler jamming techniques.

6. MONOPULSE DECEPTION JAMMING

The ability of monopulse tracking radars to obtain azimuth, range, and elevation information on a pulse-by-pulse basis make them extremely difficult to jam

(Figure 11-17). Amplitude modulation jamming used against conical scan or TWS radars, such as inverse scan and swept square wave, highlights a target, making monopulse tracking easier. Frequency modulation techniques, such as RGPO and VGPO, are equally ineffective. They serve as a beacon that aids the monopulse radar's target tracking ability. The monopulse radar may be able to track the jammer with more accuracy than tracking actual radar returns because target glint effects are absent from the jamming pulse. Monopulse angle jamming techniques can be divided into two main categories, system-specific and universal. Examples of system-specific jamming techniques include skirt frequency jamming, image jamming, and cross-polarization jamming. These techniques attempt to exploit weaknesses in the design and operation of specific monopulse radars. Cross-eye jamming, a universal technique, attempts to exploit all monopulse radar systems.

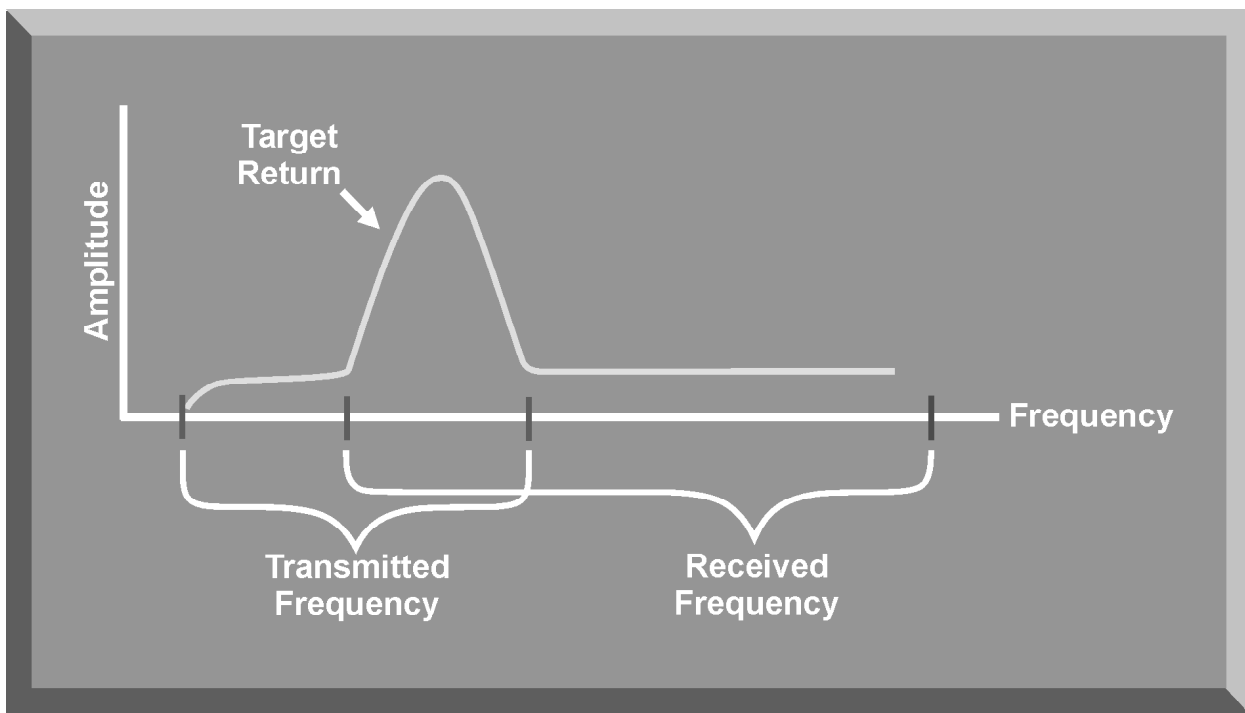

Figure 11-17. Monopulse Radar Receiver

a. Skirt frequency jamming, or filter skirt jamming, is designed to counter the monopulse receiver. Skirt frequency jamming is based on the fact that the intermediate frequency (IF) filter of the monopulse receiver must be correctly tuned to the transmitting frequency of the monopulse radar. If these two components are not exactly tuned, the target signal may be presented on the edge, or skirt, of the receiver IF filter. This offers an opportunity to inject a jamming signal into this skirt (Figure 11-18).

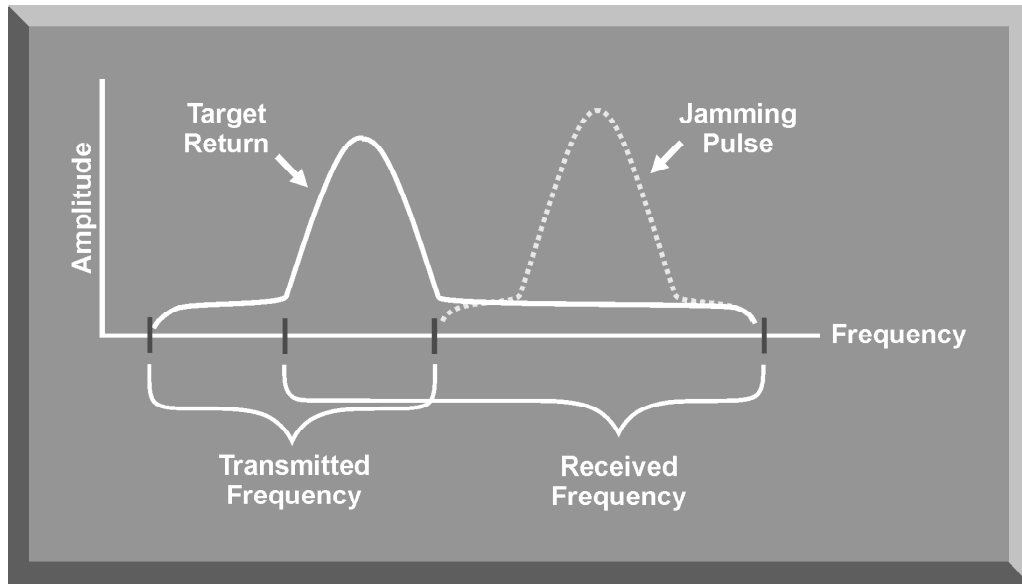

Figure 11-18. Filter Skirt Jamming Pulse

(1) Filter skirt jamming attempts to take advantage of this frequency imbalance by transmitting a jamming pulse tuned slightly off the radar transmitted frequency and in the middle of the receiver IF filter. This jamming pulse will generate a false error signal and drive the antenna away from the true target return.

(2) A well designed and maintained monopulse system does not have a frequency imbalance. The transmitter and IF filter frequencies will be identical. Jamming signals that are even slightly out of this narrow frequency range will not affect the monopulse tracking capability of the radar (Figure 11-19).

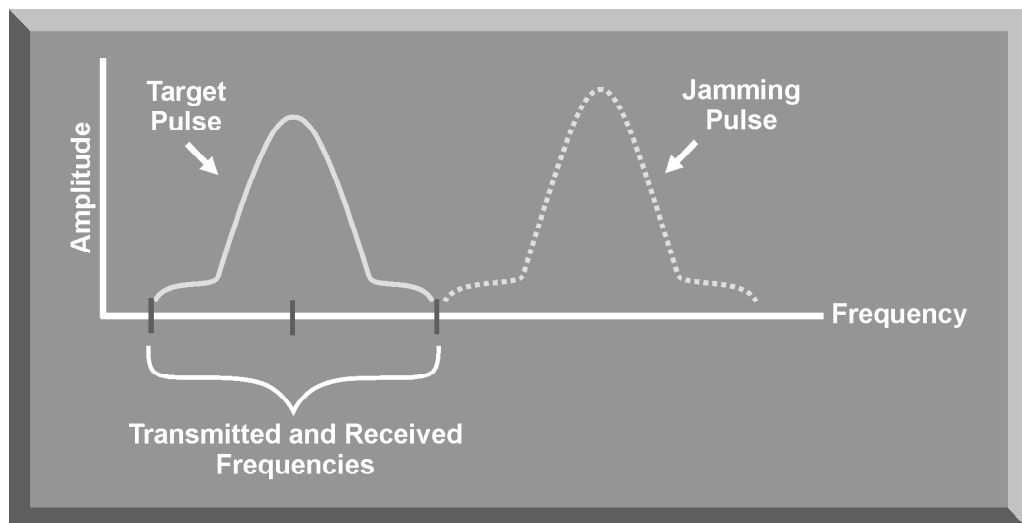

Figure 11-19. Ineffective Filter Skirt Jamming

(3) Effective filter skirt jamming requires extensive knowledge of the internal operation of the IF filter. This information can normally be obtained only by system exploitation. Variances from radar to radar and frequency imbalance exists from one radar IF filter to another. This creates a high degree of uncertainty in the effectiveness of this technique.

b. Image jamming exploits another potential weakness in the monopulse receiver (Figure 11-20). Some monopulse receivers have a wide-open front end with no preselection before the mixer. If the jammer transmits a pulse at the intermediate, or image, frequency, but out of phase with this frequency, the phase of the target tracking signal will be reversed and the antenna will be driven away from the target (Figure 11-21). Effective image jamming requires detailed information on the operation of the monopulse receiver. Of particular importance is the image, or intermediate, frequency and whether the local oscillation frequency is above or below the transmitted frequency. This may require exploitation of the monopulse threat system. In addition, a well-designed monopulse system has preselection in the front end and will reject signals that are out of phase with the transmitted frequencies. This capability renders image jamming ineffective.

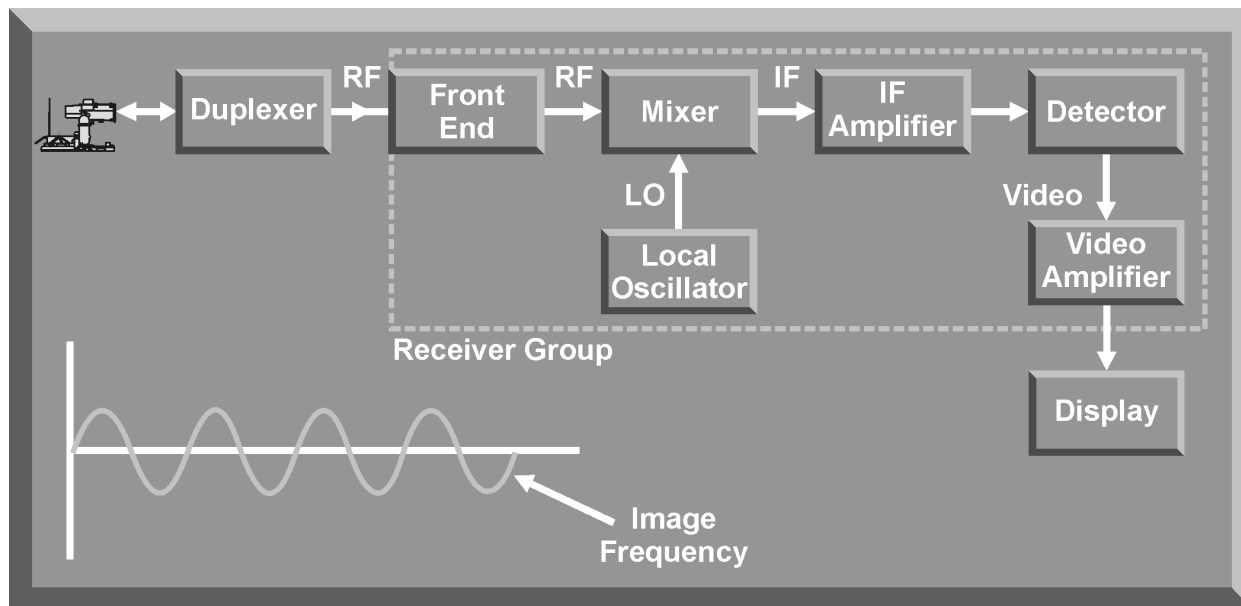

Figure 11-20. Monopulse Image Frequency

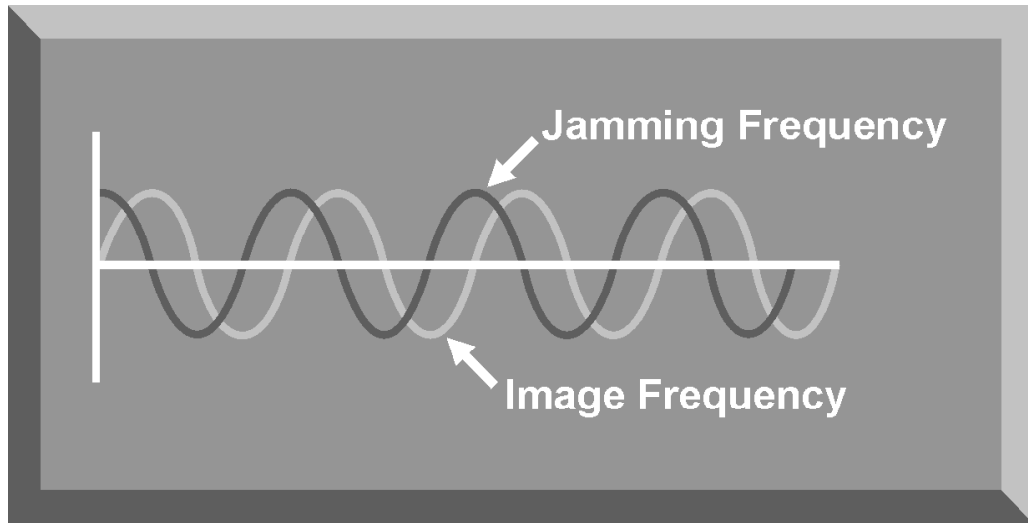

Figure 11-21. Monopulse Image Jamming

c. Cross-polarization jamming exploits the difference in the monopulse antenna pattern for a jamming pulse that is polarized orthogonal to the design polarization. The antenna pattern for a two-channel monopulse radar using sigma and delta beams shows the tracking point to be between the two beams (Figure 11-22). This is true if the radar is using its design polarization. However, the radar antenna also has a receiving pattern for a signal that is cross-polarized with the design frequency. For a cross-polarized signal, the tracking point is shifted one beamwidth to the right. This shift in the tracking point results in a target tracking signal that is 180° out of phase with the real signal. To be effective, a jamming signal polarized orthogonally to the design frequency of the radar would have to be 25 to 30 decibels, or about 1000 times, stronger than the radar signal.

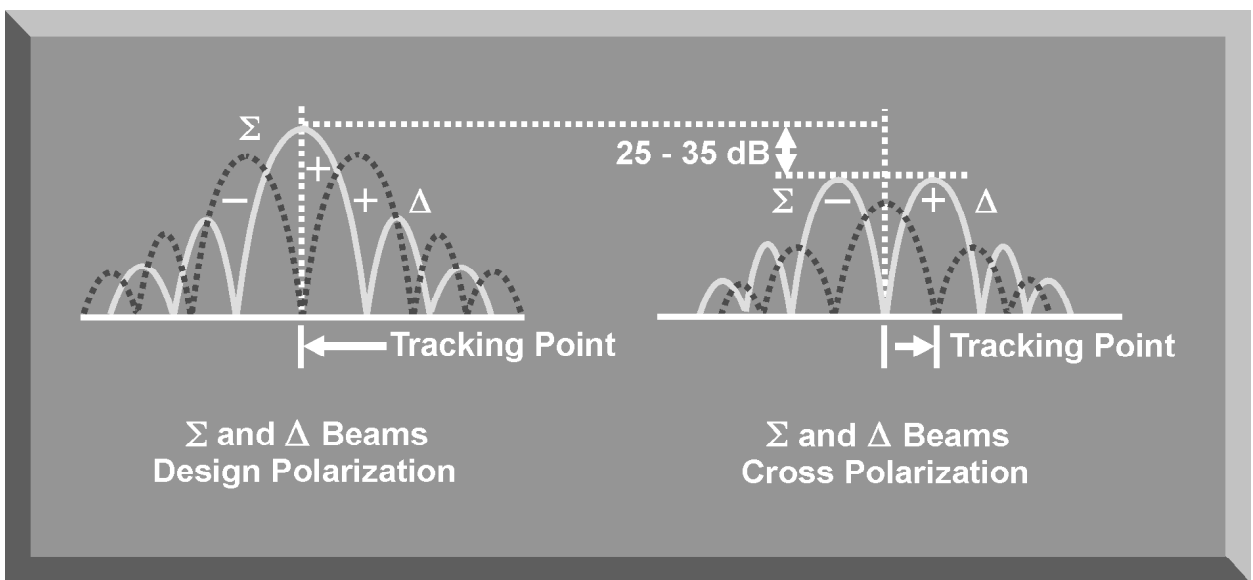

Figure 11-22. Cross-Polarization Antenna Pattern

(1) A cross-polarized jammer must receive and measure the polarization of the victim monopulse radar. The jammer then transmits a very high power jamming signal at the same frequency, but orthogonally polarized, to the victim radar. As a rule, the jamming signal must be 25 to 30 dBs stronger than the target return to exploit the tracking errors in the cross-polarized antenna pattern. Additionally, it must be as purely orthogonal to the design polarization as possible. Any jamming signal component that is not purely orthogonal will highlight the target and require more jamming power to cover the target return.

(2) A cross-polarized jammer must be able to generate a powerful jamming pulse that is polarized orthogonal to the victim radar. A cross-polarized jammer that generates the power and purity of polarization required to defeat monopulse angle tracking poses extreme technological challenges.

d. Cross-eye jamming is a complex technique that attempts to distort the wavefront of the beams in a monopulse radar and induce angle tracking errors. It exploits two basic assumptions of monopulse tracking logic in comparing target returns on a pulse-by-pulse basis. The first assumption is that a target return will always be a normal radar pulse echo. The second assumption is that any shift in amplitude or phase in a target return is due to the tracking antenna not pointing directly at a target. This condition generates an error signal and the antenna tries to null, but the amplitude or phase shifts.

(1) Cross-eye jamming attacks the two assumptions through a process of receiving and transmitting jamming pulses from different antennas separated as far apart as possible. In Figure 11-23, the phase front of a monopulse signal is received by the number 1 receive antenna, amplified by the repeater, and transmitted by the number 2 transmit antenna. The same phase front then hits receive antenna number 2, is shifted 180°, amplified by the repeater, and transmitted by the number 1 transmit antenna. These two out-of-phase signals must be matched in amplitude and must exceed the amplitude of the target return.

(2) When these jamming signals arrive at the victim radar, the tracking loop attempts to null out the amplitude and phase differences. With two widely spaced jamming sources at different phases, the antenna never achieves a null position or tracking solution. The distance between antenna pairs is an important parameter that determines the effectiveness of cross-eye jamming. The wider the spacing between antenna pairs, the more distortion in the victim's wave front near the true radar return. Most fighter aircraft do not provide sufficient spacing between the antennas to maximize effectiveness. Effectiveness is also lost when the aircraft is abeam or going away from the radar. To further complicate matters, when the radar is directly in front of the aircraft, the jamming pulses must have a power at least 20 dBs above the target return. Cross-eye jamming can also be defeated with a leading-edge tracker that rejects jamming signals arriving at the antenna behind the target return.

(3) Countering monopulse angle tracking is the greatest challenge for self-protection jamming systems. Skirt jamming and image jamming have had limited success. Cross-polarization and cross-eye jamming techniques require complex and sophisticated circuitry and much power.

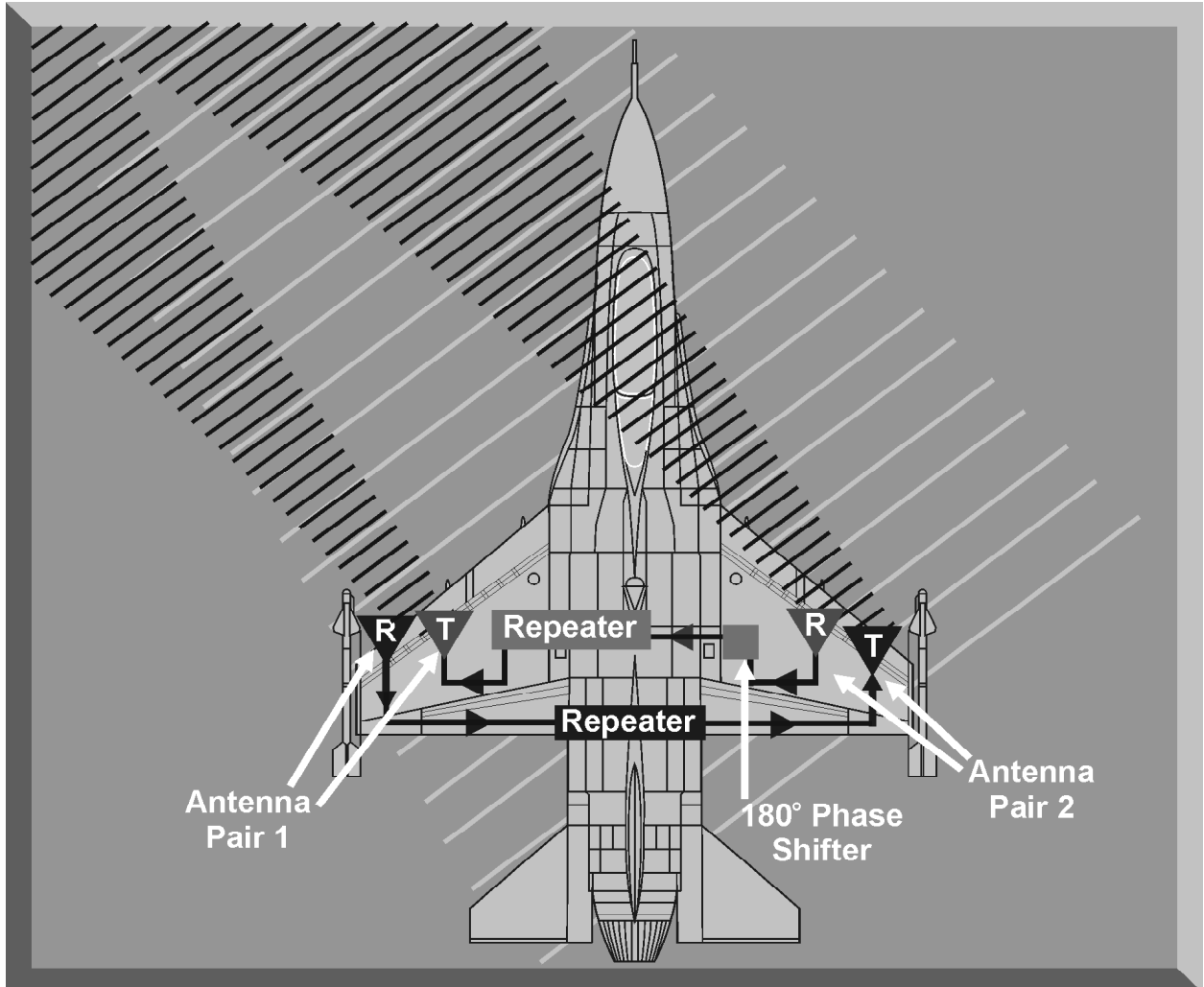

Figure 11-23. Cross-Eye Jamming

7. TERRAIN BOUNCE

Terrain bounce is a jamming technique used primarily at low altitude. It is used to counter semi-active, air-to-air missiles and monopulse tracking radars. The technique involves a repeater jammer that receives the radar or missile guidance signal. The jammer amplifies and directs this signal to illuminate the terrain directly in front of the aircraft. The missile or radar tracks the reflected energy from the spot on the ground instead of the aircraft (Figure 11-24).

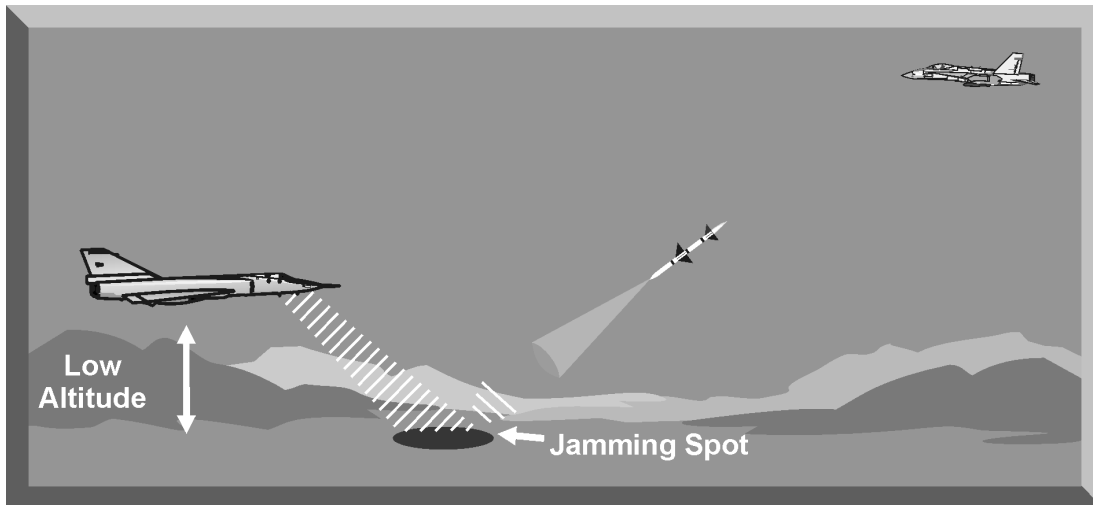

Figure 11-24. Terrain Bounce

a. To be effective, the terrain bounce jamming antennas should have a narrow elevation beamwidth and a broad azimuth beamwidth. This transmission pattern maximizes the energy directed toward the ground and minimizes the energy transmitted toward the missile or radar. To overcome signal losses associated with uncertain terrain propagation, the jamming system should also generate high jamming power. This ensures the energy reflected from the terrain is higher than the energy in the aircraft return. The terrain bounce jamming antennas should have very low sidelobes to preclude activation of any home-on-jam (HOJ) missile capability. For an air-to-air missile, the terrain bounce technique should be activated at long range. This will initially put the aircraft and the jamming spot in the same resolution cell. As the range decreases, the missile will be decoyed by the higher power in the jamming spot.

b. Some problems associated with terrain bounce jamming include the uncertainty of the signal scattering parameters of the various terrain features and the possible changes in signal polarization caused by terrain propagation. In addition, terrain bounce jamming can place maneuvering restrictions and maximum altitude limitations on the aircraft.

8. SUMMARY

There are several deception jamming techniques that can be employed to counter threat radar systems. The effectiveness of these techniques can be enhanced when they are employed in combination. For example, the effectiveness of an RGPO technique is enhanced when an angle deception technique is also employed. Determining the most effective deception technique, or combination of techniques, can present a challenge to intelligence and engineering analysts. However, when employed with maneuvers and chaff, deception techniques can mean the difference between success and failure on the modern battlefield.

CHAPTER 12. DECOYS

1. INTRODUCTION

A decoy is a device designed to look to an enemy radar more like an aircraft than the actual aircraft itself. Decoys do three primary missions: they saturate the enemy's integrated air defense system (IADS), coerce the enemy into exposing his forces prematurely, and defeat tracking by enemy radar. This chapter will discuss saturation decoys, towed decoys, and expendable active decoys. Chaff and flare systems will be discussed in separate chapters.

2. SATURATION DECOYS

A saturation decoy is usually an expendable vehicle designed to emulate a penetrating aircraft. Its mission is to deceive and saturate an enemy's IADS. Employing multiple saturation decoys can force an IADS to devote critical resources to engage these false targets. This depletes enemy assets available to engage penetrating aircraft. In addition, ground or air launched saturation decoys can be used to stimulate the IADS, to collect intelligence data, or to initiate attacks by suppression of enemy air defense (SEAD) assets. The three main characteristics of saturation decoys are their electronic signature, their flight program, and their mission type.

a. Saturation decoys must present an electronic signature, or radar return, that is indistinguishable from the aircraft they are protecting. Decoys can do this by either passive or active measures, or use a combination of both. A passive decoy is essentially a flying radar reflector. The size, shape, and materials used in the decoy are optimized to ensure that the proper amount of radar energy is returned to the enemy radars. Active decoys employ radar repeater systems to receive the enemy radar signal, amplify it and send back a radar return of the proper size to confuse the enemy. Reflecting or transmitting the proper size radar return is critical for both passive and active decoys. A return that is too large or too small will allow the enemy radar operator to differentiate between decoys and aircraft, causing the decoys to be ignored.

b. To continue deceiving an enemy IADS, a decoy must do more than provide the proper-sized radar return. Possessing flight characteristics similar to the aircraft it is protecting increases the probability that the decoy will effectively deceive an IADS for a sustained period of time. Modern decoys can either be powered with rockets, miniature engines, or simply glide for very long distances based upon the altitude and airspeed of the jet that releases them. Additionally, their flight paths can be pre-programmed into an onboard autopilot, allowing the decoy to fly an independent ground track, thus increasing their appearance as attack aircraft worth tracking.

c. Saturation decoys carry out two of the three decoy missions. Launched in significant numbers, they can saturate or overburden an IADS. Meanwhile, their realistic electronic image and preprogrammed flight paths entice the enemy to turn on radars and show his forces.

(1) Saturation decoys launched in coordination with an attacking strike package force the enemy to take time to process meaningless tracks and tie up critical assets. In this role, decoys primarily work against the early warning network of the enemy IADS by presenting the IADS with numerous targets to sort and track. Resources committed to tracking decoys may not be available to track actual aircraft. Additionally, if an enemy knows that decoys are present, he may not commit any resources against targets for fear they are just decoys.

(2) Time of radiation or “emission control” is a critical factor for acquisition and target tracking radars. To be effective and survive on the battlefield, ground threat radars radiate as little as possible; too much time radiating allows ELINT collectors to find their location and either direct aircraft to avoid them or call in an attack upon them. Therefore, when a decoy can get a radar to emit, the radar is now essentially compromised and can be avoided or attacked. Getting the enemy's radars to emit is called “stimulating the IADS,” which is generally a precursor to any threat suppression mission.

(3) An extremely successful example of using decoys to stimulate the IADS was carried out in the Bekaa Valley in 1982. The Israelis opened the conflict by launching saturation decoys to successfully simulate an attack. While the Syrians reloaded, Israeli fighters attacked, destroying 17 of 19 Syrian SA-6s in the beginning of the battle. With the ground threat neutralized, the Israeli Air Force went on to destroy 85 Syrian fighters in the pure air-to-air conflict that resulted.

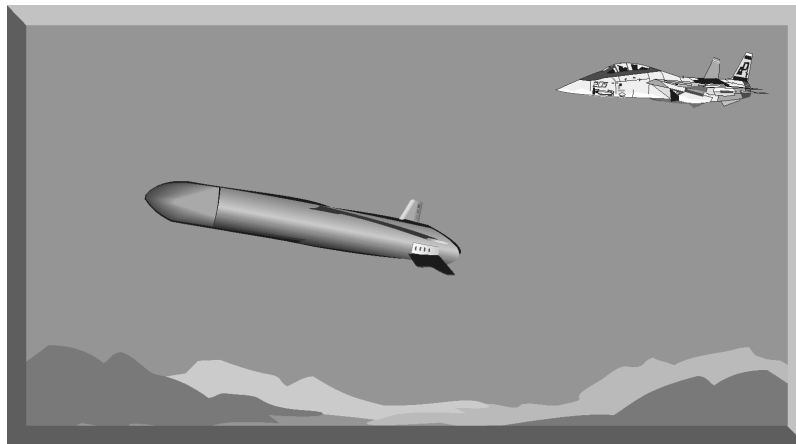

Figure 12-1. Tactical Air Launched Decoy

d. Two examples of saturation decoys are the Navy's Tactical Air Launched Decoy (TALD) in Figure 12-1 and the Air Force's proposed Miniature Air Launched

Decoy (MALD) in Figure 12-2. Both of these decoys can work actively or passively and both have pre-programmable flight paths. The TALD is an unpowered decoy normally launched from an F-14 Tomcat. The Air Force's MALD is a smaller jet-powered decoy also designed to be used by fighter aircraft. The MALD is 90 inches long, 6 inches in diameter, and has 25-inch wings that are foldable—essentially it is the size of an air-to-air missile. Because of its small size, the MALD can be carried into the target area before it is launched. Once launched it uses its speed, independent flight path, and electronically manipulated radar signature to make acquisition radars and target tracking radars mistake it for one of the attacking aircraft.



Figure 12-2. Miniature Air Launched Decoy (MALD)

3. TOWED DECOYS

A towed decoy is a small jammer that is physically attached to the aircraft (Figure 12-3). Unlike the saturation decoys that work against the IADS, the towed decoys are for individual aircraft survival. Towed decoys are designed to defeat enemy missiles in the final stages of an engagement; therefore, towed decoys, as well as other expendables, are known as endgame countermeasures. While towed decoys are primarily designed to provide sufficient miss distance between an attacking semi-active radar missile and the protected aircraft, they may also be effective against pulse Doppler radars and monopulse radars.

a. To be effective, the towed decoy must turn on within the threat radar's resolution cell after the radar is tracking the protected target. To successfully decoy the missile, the towed decoy must return radar signals with sufficient power to simulate a radar cross section (RCS) significantly larger than that of the

protected target. There are currently two generations of towed decoys on the market. Their primary difference lies in the connection each has with the aircraft towing it.

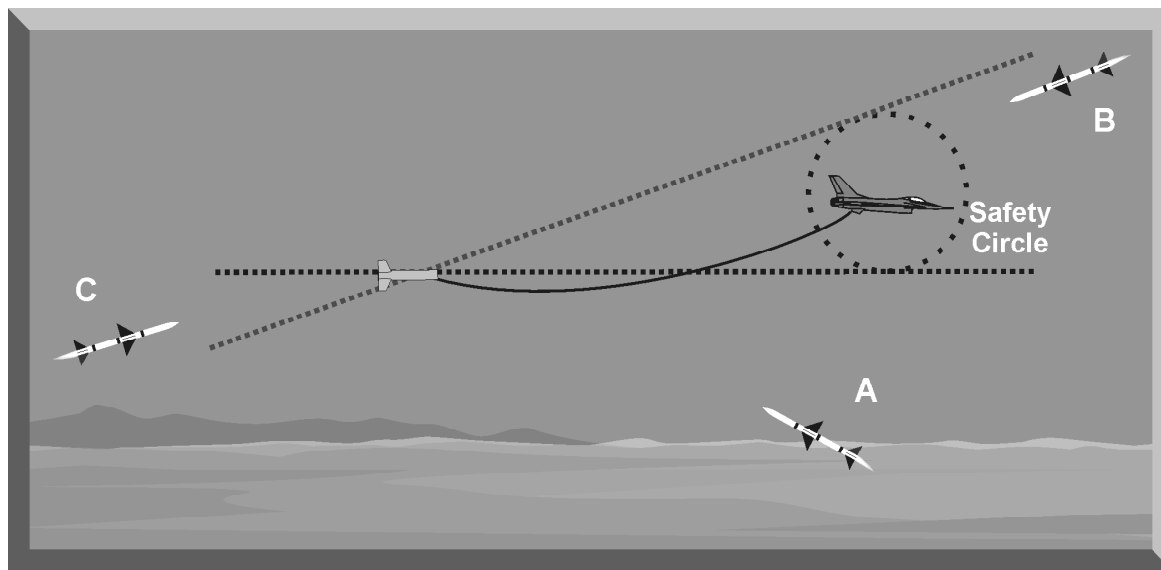

Figure 12-3. Towed Decoy

(1) The first generation of towed decoys contains a simple repeater jammer that enhances any signal it receives in the proper frequency range. The enhanced signal is stronger than the aircraft signal so the missile is lured towards the decoy. These decoys are stand-alone units that contain all the electronics, processors, receivers and transmitters within them. The only tie to the aircraft is for power and status. One of the big advantages of these simple repeater devices is that they do not require the exact frequency of the enemy radar systems to be effective, they will enhance any signal coming at them. An area of concern with the use of towed decoys is possible conflict between the onboard jamming system and the towed decoy. The onboard system could overpower the decoy, causing the attacking missile to ignore the decoy and track the aircraft.

(2) The second generation of decoys is tethered to the aircraft via fiber optic cable. Through this cable travels the different jamming modulations to be used by the decoy. These fiber optic towed decoys (FOTD) only contain the transmitters; the remaining items are in the jet or the pod. This system allows for more complex jamming through the decoy, including cooperative jamming between the aircraft and the decoy.

b. The separation required between the decoy and the aircraft is a primary consideration in developing a towed decoy system. The towed decoy should be positioned far enough behind the aircraft to preclude warhead fragments from missiles guiding on the decoy from also impacting the aircraft. Missile A in Figure

12-3 depicts a situation where the missile will detonate well outside of the aircraft's safety circle. From a pilot perspective, any restrictions on aircraft maneuvering imposed by a towed decoy are very important. The number of decoys that can be carried and the time required for decoy deployment are also important employment considerations.

c. Achieving 360° coverage is a primary limitation of a towed decoy system. When an aircraft equipped with a towed decoy is abeam a threat radar, the radar may be able to discriminate between the aircraft and the decoy. This is a function of the resolution cell of the radar. In addition, missiles approaching from a high-aspect angle, and above the aircraft (Figure 12-3 - Missile B), may fuse on the aircraft while guiding to the decoy. Missiles approaching from a low-aspect angle (Figure 12-3 - Missile C) may not fuse on the decoy and subsequently acquire and fuse on the aircraft. Finally, if the decoy is destroyed or lost, the time required to deploy a replacement decoy is critical, especially if the aircraft is engaged by multiple missiles.

d. An example of a fielded towed decoy system is the AN/ALE-50 (Figure 12-4). This first generation towed decoy system is found on Air Force F-16 and B-1 aircraft, and there is a version that is integrated into the ALQ-184 pod.

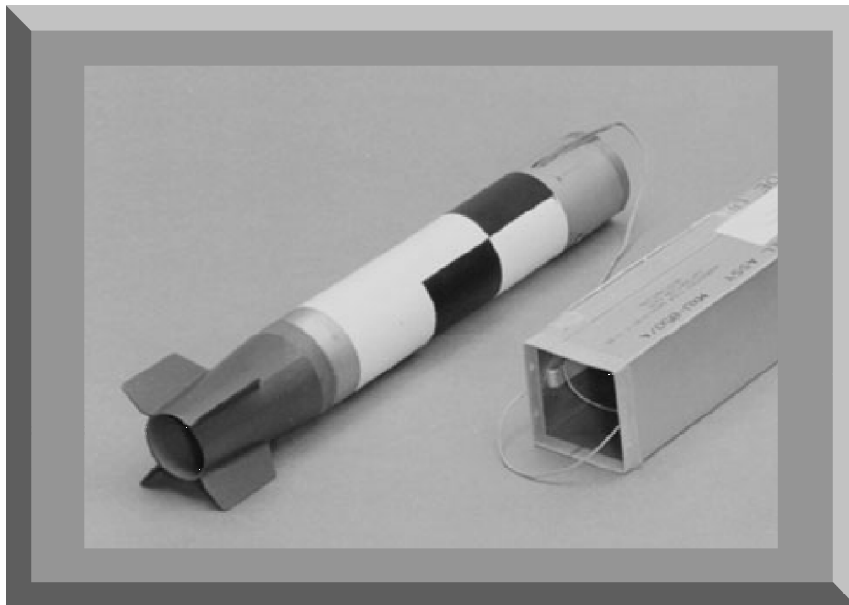

Figure 12-4. AN/ALE-50 System

(1) The system consists of a launch controller subsystem and towed decoys. The launch controller houses the decoy before it is launched, provides power to the decoy, and provides for the monitoring of the electronics. The decoy body is a factory sealed, self-contained unit with everything except for power. Power comes through the tether from the host aircraft; the decoy sends its operating status back through the tether to the aircraft.

(2) ALE-50 decoy use is cleared throughout the flight regime of the F-16 and B-1. Decoys can be deployed without being turned on, but once a decoy has been deployed, it cannot be reeled back in and must be severed before landing. Procedures are in place to reduce the chance that the onboard jamming system will negate the decoy.

(3) The ALE-50 towed decoy is a wideband RF repeater that provides self-protection EA by receiving, electronically amplifying, and retransmitting enemy radar RF signals. Upon receiving a threat radar signal, this simple repeater amplifies the signal and retransmits it. This provides the radar with two signals, one reflected from the aircraft and a stronger one from the decoy. With the signal from the decoy being the more attractive, the radar or missile guides towards the decoy. During combat operations over Kosovo, ALE-50 decoys were credited with saves for both F-16s and B-1s.

4. EXPENDABLE ACTIVE DECOYS

Expendable active decoys are designed to lure the tracking gates of an enemy's radar away from the aircraft. They are endgame countermeasures like towed decoys, but they differ in that expendable decoys free-fall or glide to the ground as opposed to being towed behind the aircraft.

a. Expendable decoys are small, active jamming systems designed to be expended by existing aircraft chaff and flare dispensers, such as the AN/ALE-40 or the AN/ALE-47. Expendable decoys can employ noise or deception jamming with noise jamming being the most common. Deception jamming techniques can be employed to enhance effectiveness against pulse Doppler radars. There are two challenges associated with expendable jammers: the amount of the time the jammer is effective and the packaging (Figure 12-5).

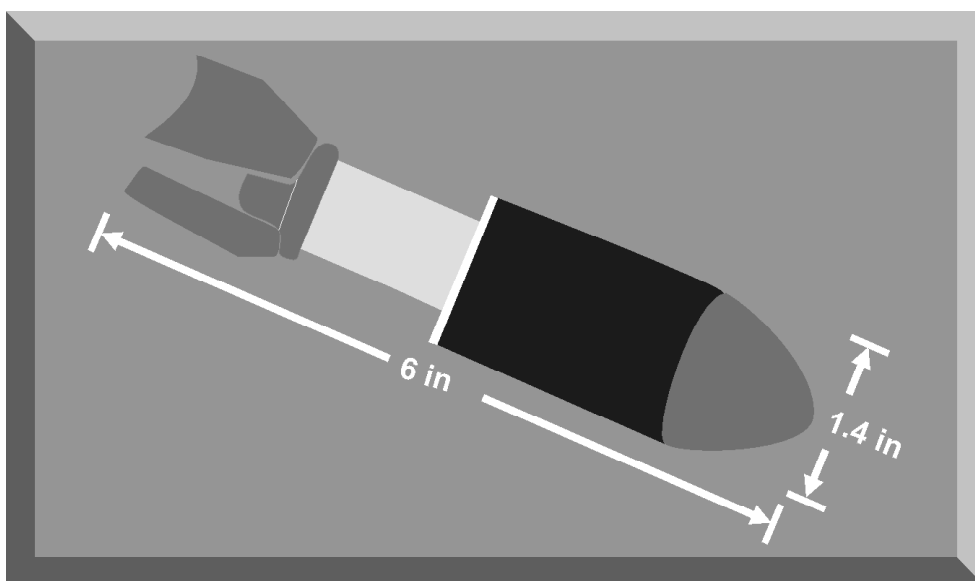

Figure 12-5. Generic Expendable

b. Expendable decoys are designed to provide protection for the dispensing aircraft for a specific period. The dispensing altitude and rate of fall determine this period of effective coverage. Expendable decoys can employ small parachutes of aerodynamic design to slow the rate of fall and increase the time of effective coverage. If the period of coverage is too short, multiple expendable decoys must be employed. This places a premium on timely employment and expendables management.

c. The primary components of an expendable decoy are the transmit and receive antennas, techniques generator, amplifier, and power supply. The transmit and receive antennas should be isolated and capable of high gain, wide bandwidth, and should use compatible polarization with the victim radar. The techniques generator must recognize the victim radar signal and generate the appropriate jamming response. The amplifier must be capable of generating a high power jamming signal over a wide frequency range. To meet these requirements, sophisticated computer and miniaturization techniques are used, and the components packaged to all fit in the aircraft dispenser. These factors impact the cost of expendable decoys and may limit the availability of these assets.

d. The Generic Expendable, RTE-1489, commonly called the GEN-X decoy is a fielded expendable active decoy. The decoy is sized to fit into a 1.4 x 1.4 x 5.8 inch cartridge and take advantage of new microwave/millimeter-wave integrated circuit (MMIC) technology. The GEN-X is programmable and features a broadband antenna and wide frequency coverage. After ejection, the decoy extends three small fins for stability. Its battery ignites to provide power, the receiver locks on to the threat radar signal, and a deception signal is generated and transmitted.

5. SUMMARY

Decoys simply provide the enemy with more targets to process. In the case of saturation decoys, this forces the enemy to commit resources against false targets, or show his defenses. For towed decoys and expendable active decoys, it makes the missile or tracking radar separate a real target from more electronically attractive decoys.

CHAPTER 13. CHAFF EMPLOYMENT

1. INTRODUCTION

Chaff was first used during World War II when the Royal Air Force, under the code name “WINDOW,” dropped bales of metallic foil during a night bombing raid in July 1943 (Figure 13-1). The bales of foil were thrown from each bomber as it approached the target. The disruption of German AAA fire control and ground control intercept (GCI) radars rendered these systems almost totally ineffective. Based on this early success, chaff employment became a standard bomber tactic for the rest of the war.

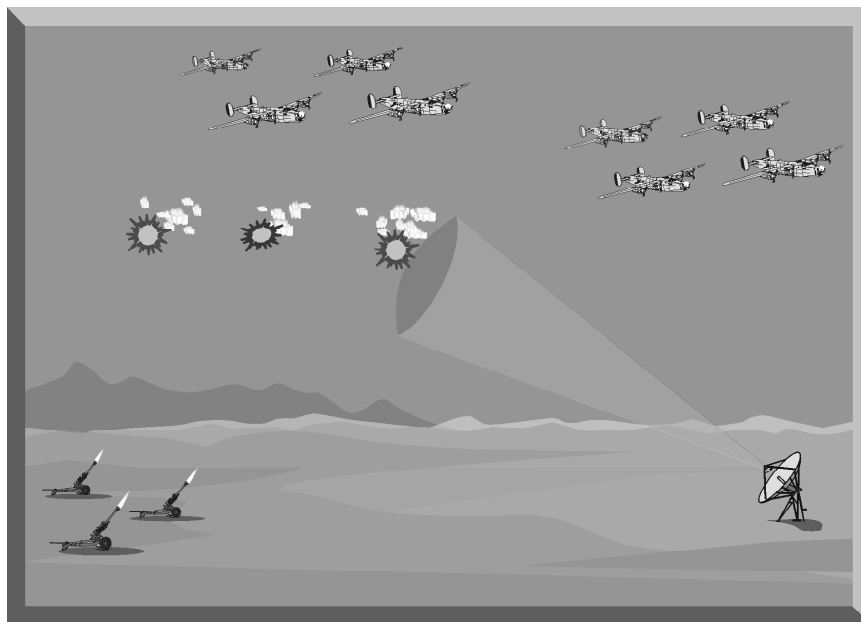

Figure 13-1. “WINDOW” – The First Operational Employment of Chaff

a. Chaff is one of the most widely used and effective expendable electronic attack (EA) devices. It is a form of volumetric radar clutter consisting of multiple metalized radar reflectors designed to interfere with and confuse radar operation. It is dispensed into the atmosphere to deny radar acquisition, generate false targets, and to deny or disrupt radar tracking. Chaff is designed to be dispensed from an aircraft and function for a limited period.

b. Even with the development and deployment of advanced radar threat systems, chaff continues to be an extremely effective EA device. Experience gained during the Vietnam conflict, the 1973 Yom Kippur War, and DESERT STORM clearly shows that chaff effectiveness against radar threats is still a factor with which the enemy must contend. This is especially true when chaff is employed with self-protection jamming and aircraft maneuvers.

c. Chaff screening and self-protection are the two basic chaff employment tactics. Chaff screening tactics, including area saturation and chaff corridor employment, are designed to confuse and deny acquisition information to the early warning, GCI, and acquisition radars supporting surface-to-air missile (SAM) systems. Self-protection tactics are designed to counter acquisition and target tracking radars (TTRs). When used with jamming and maneuvers, chaff can cause TTRs to break lock or generate survivable miss distances if a SAM is fired at the aircraft.

2. CHAFF CHARACTERISTICS

To understand how chaff affects radar systems, it is important to understand its characteristics. The most important chaff characteristics are radar cross section (RCS), frequency coverage, bloom rate, Doppler content, polarization, and persistence.

a. RCS is a measure of the net reradiated energy from a target to the illuminating radar. The RCS of an aircraft varies based on the size, shape, type of skin surface, configuration, and aspect to the illuminating radar. Figure 13-2 shows the effect of aspect on aircraft RCS. The RCS is greatest when the aircraft aspect is 90° , or abeam the radar. The lowest RCS occurs near the 30° - 70° and 110° - 150° of aspect. Since the aircraft RCS also varies based on frequency, the victim radar's frequency is a key factor. To be effective, chaff must be dispensed in large enough quantities to create an RCS greater than the aircraft RCS.

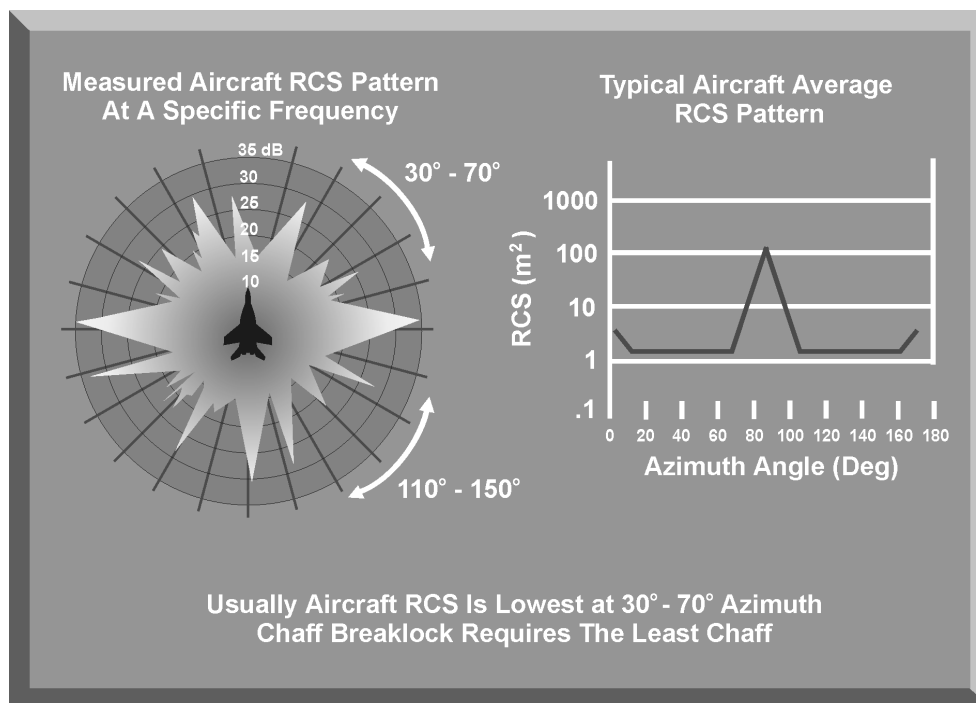

Figure 13-2. Aircraft Radar Cross Section (RCS)

(1) The RCS of a chaff bundle depends on the frequency of the victim radar and the dispensing aircraft's relative position, or aspect. Figure 13-3 shows the RCS of a single RR-170 chaff cartridge based on frequency. It shows that the largest RCS occurs at about 3 GHz. However, for the spectrum between 2-18 GHz, which includes most SAM TTRs, the RCS of the RR-170 cartridge is over 50 square meters. Since the typical fighter aircraft RCS varies between 1 and 10 square meters, depending upon frequency and aspect, the RR-170 chaff cartridge should provide a sufficient RCS to mask the aircraft RCS.

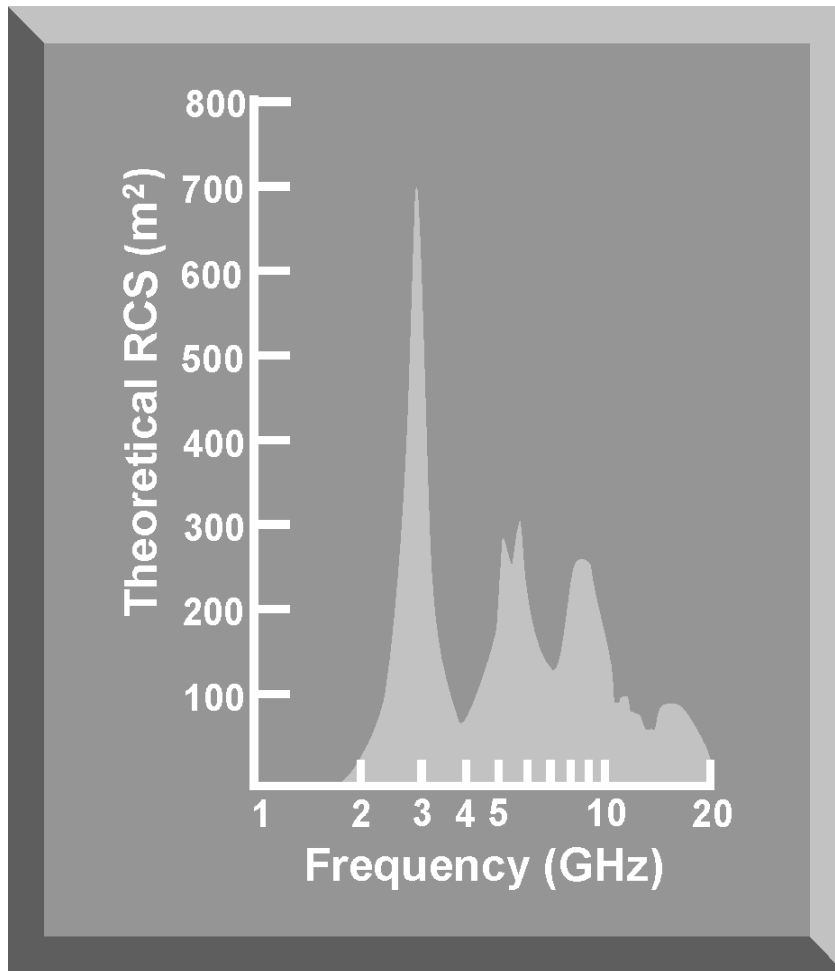

Figure 13-3. RR-170 Chaff Cartridge RCS

(2) The angular relationship, or aspect, between the aircraft and chaff bundle affects the chaff RCS presented to the victim radar. Chaff RCS is greatest when the chaff bundle and the aircraft are abeam the threat radar. It is smallest when the threat radar is off the nose or tail of the aircraft. Aspect is important when developing self-protection maneuvering and chaff dispensing tactics against threat radars (Figure 13-4).

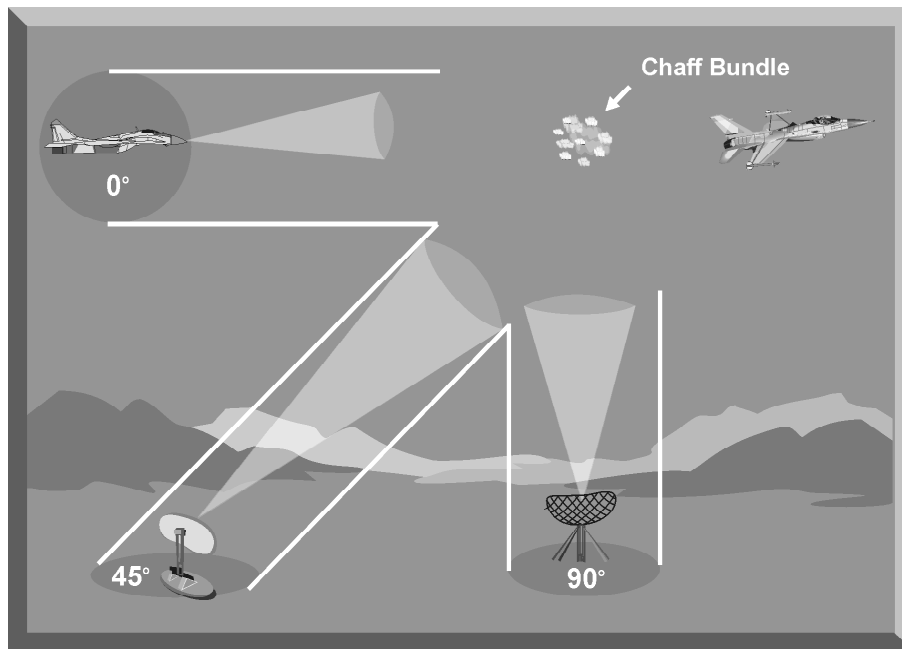

Figure 13-4. Threat Radar Aspect and Chaff RCS

(3) Dispensing multiple chaff bundles simultaneously does not necessarily increase chaff RCS. Multiple bundles increase the density of the chaff but do not directly enhance self-protection capabilities (Figure 13-5). This is an important consideration when developing chaff dispenser rates to counter threats.

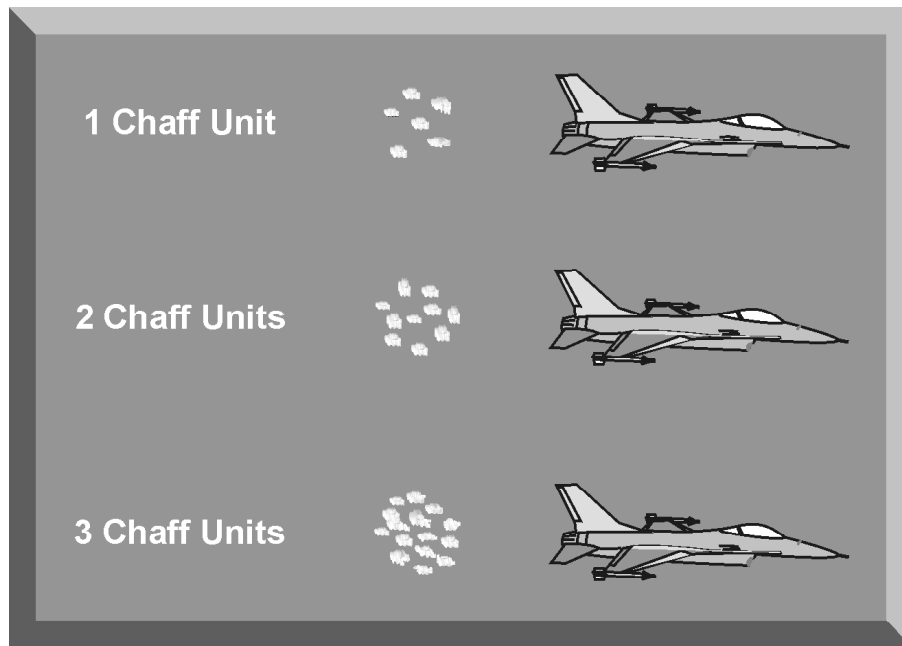

Figure 13-5. Impact of Multiple Chaff Cartridge Employment on Chaff RCS

b. Each strip of chaff is a dipole reflector that reradiates the electromagnetic energy received from an emitting radar and creates a radar echo. The optimum size is cut to about one-half the wavelength of the victim radar's RF. Since a single cut length is restricted in effectiveness to a narrow range of frequencies, different lengths are normally packaged together to provide coverage over a wide range of frequencies (Figure 13-6).

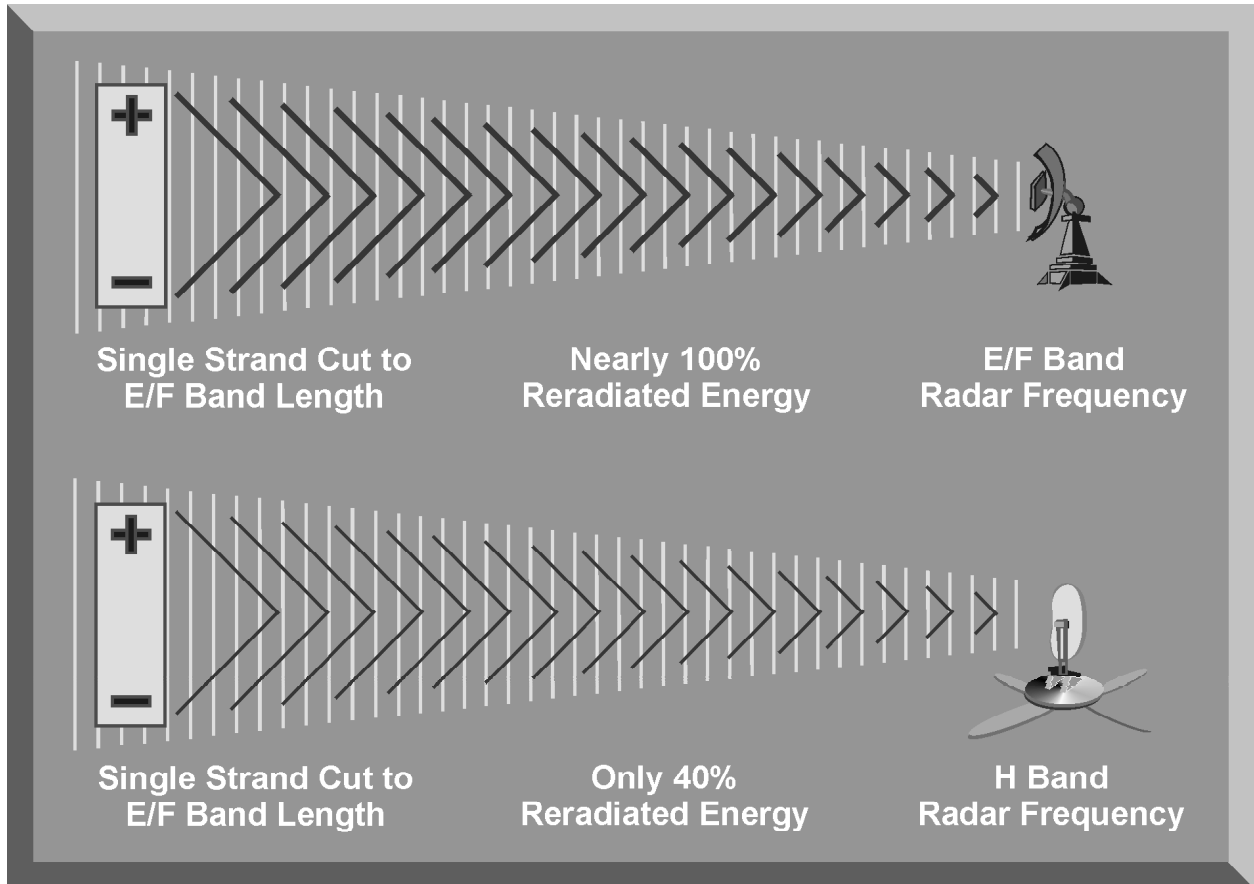

Figure 13-6. Chaff Length and Frequency Coverage

(1) Considerable research and development has reduced the size and increased the effectiveness of self-protection chaff. There are various chaff sizes, shapes, and materials. Most chaff carried on fighter aircraft are made of small aluminum strips, coated strips of nylon, or fiberglass. These strips are cut to various lengths and compressed into bundles that are small and light enough to allow the aircraft to carry and dispense multiple chaff bundles. These cuts of chaff are packaged into chaff cartridges and inserted into a dispenser on the aircraft. An explosive squib assembly ejects the cartridges from the dispenser and disperses the chaff (Figure 13-7).

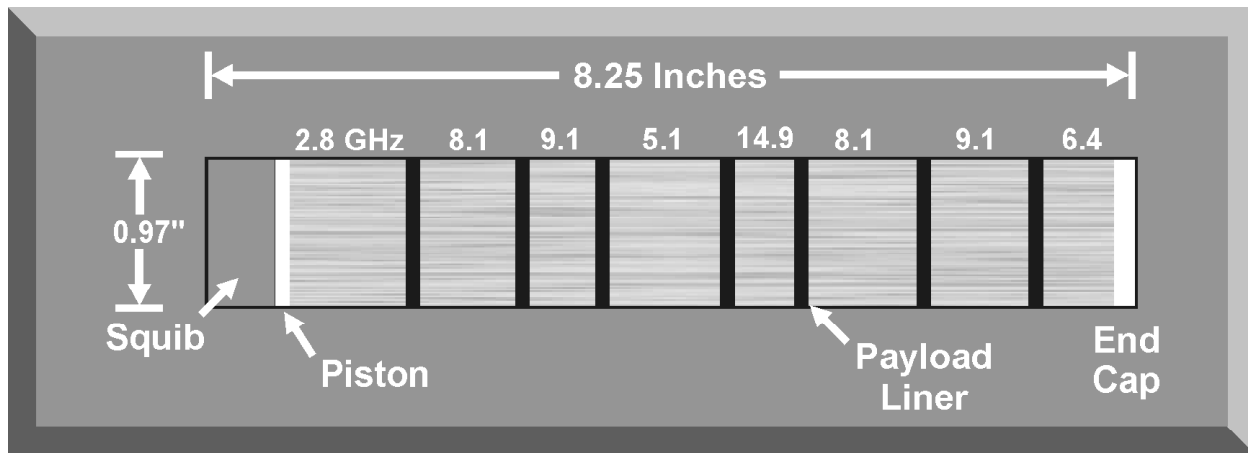

Figure 13-7. RR-170 Chaff Cartridge

(2) To provide as many dipoles as possible and present the maximum radar cross section, each chaff bundle has numerous chaff cuts to match a predetermined range of frequencies. Each chaff cartridge contains almost 3 million dipoles packaged in an eight inch by one-inch cartridge. The dipole frequencies cover the frequency range where most SAM TTRs and air-to-air radars operate (2 - 18 GHz).

c. Bloom rate, the rate at which chaff will scatter, is also a very important characteristic of self-protection chaff. Self-protection chaff effectiveness is based on the relationship of bloom rate, chaff RCS, aircraft RCS, and the resolution cell of the threat radar system. The ability of chaff to effectively defeat a target tracking radar is directly related to the chaff dispense rate, which determines the chaff RCS, which should be larger than the aircraft's RCS. The chaff bundles must also bloom within the resolution cell of the radar.

(1) Chaff bloom rate is dependent on aerodynamic factors associated with the chaff type, the location of the dispenser on the aircraft, and the aircraft wake or turbulence. Heavy or dense chaff falls faster and blooms slower than lighter and less dense chaff. The location of the chaff dispenser on the aircraft affects the airflow in which the chaff will be dispensed. The ideal position for the dispenser is in the area where there is the most turbulence from the aircraft. Turbulence behind the aircraft is probably the most important factor affecting bloom rate. The more turbulent the airflow, the greater the bloom rate (Figure 13-8). Maneuvering the aircraft while dispensing chaff also enhances the chaff bloom rate.

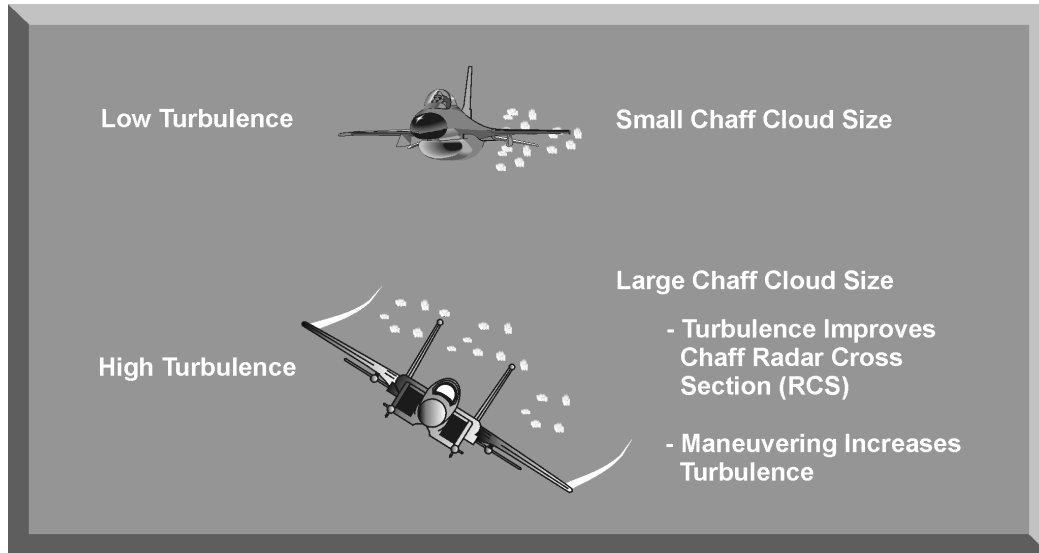

Figure 13-8. Impact of Turbulence and Chaff Bloom Rate

(2) To ensure that the victim radar is decoyed or that it transfers automatic tracking to the chaff, the chaff must bloom within the radar resolution cell. This resolution cell is a three-dimensional spheroid with dimensions based on the pulse width, horizontal beamwidth, vertical beamwidth, and the range of the aircraft (Figure 13-9). There are some rules of thumb that can be used when considering the bloom rate of chaff and the resolution cell of a particular radar. The shorter the pulse width of a radar, the faster the chaff has to bloom to be effective. The narrower the horizontal and vertical beamwidths, the faster the chaff has to bloom to be effective.

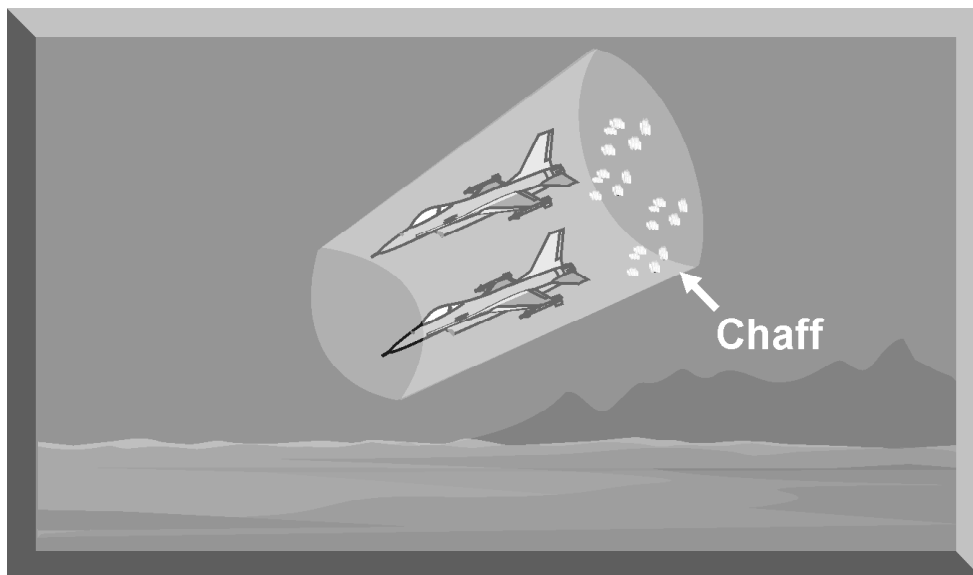

Figure 13-9. Chaff Bloom Rate and Radar Resolution Cell

d. Against Doppler radars, self-protection chaff is most effective when dispensed at or near the beam, relative to the threat radar. When chaff is dispensed in the airstream, the drag on an individual dipole is so great compared to its mass that it slows to the velocity of the surrounding air mass almost instantly. Since the relative velocity of the chaff, in relation to the radar, is zero, radar systems employing Doppler processing and tracking will not display the chaff. Doppler processing radars will continue to track the aircraft unless it also has a relative velocity of zero. This occurs when the aircraft is abeam the radar. Chaff corridor and area saturation tactics against Doppler tracking radars will have limited effectiveness.

e. Chaff persistence and polarization are two additional characteristics that are important employment considerations for area saturation or chaff corridor operations. These individual chaff element characteristics are directly related to the combined effects of aerodynamic, atmospheric, and gravitational influences.

(1) Chaff persistence is the length of time the chaff is at an effective altitude to screen ingressing aircraft during area saturation or chaff corridor operations. The time span depends on the fall rate of the chaff and varies according to the density of the dipoles. The prevailing atmospheric conditions, such as wind and temperature also affect chaff persistence. Generally, the longer cuts used for lower frequency radars fall faster than the shorter cuts used for higher frequency radars. Each type has its own rate of fall based on these conditions. The rate of fall is a critical mission planning consideration for determining the amount of time between chaff corridor or area saturation initiation and the arrival of the aircraft being screened. If the chaff is employed too early, it may not be at the correct altitude or may have dispersed to the point that it is not effective to screen ingressing aircraft.

(2) Each chaff strand is a polarized dipole with positive and negative ends. The orientation of these strands determine their polarity (Figure 13-10). Chaff cuts with the positive and negative ends oriented vertically are vertically polarized. Chaff cuts with the positive and negative ends oriented horizontally are horizontally polarized. Since chaff strands are initially buffeted by turbulence and airstream vortices, the dipole orientation and polarization, changes rapidly and randomly. Eventually, the strands separate into two groups; one descending horizontally, and one descending vertically. Since the vertically oriented strands tend to fall faster, the lower part of the chaff cloud tends to become more vertically polarized, while the upper portion is horizontally polarized. A threat radar that uses vertical polarization will receive minimal affects from the upper (horizontally polarized) portion of the chaff cloud. If the aircraft being screened are flying within this portion of the chaff cloud, they may be detected and engaged. This is another mission planning consideration for chaff area saturation or chaff corridor operations.

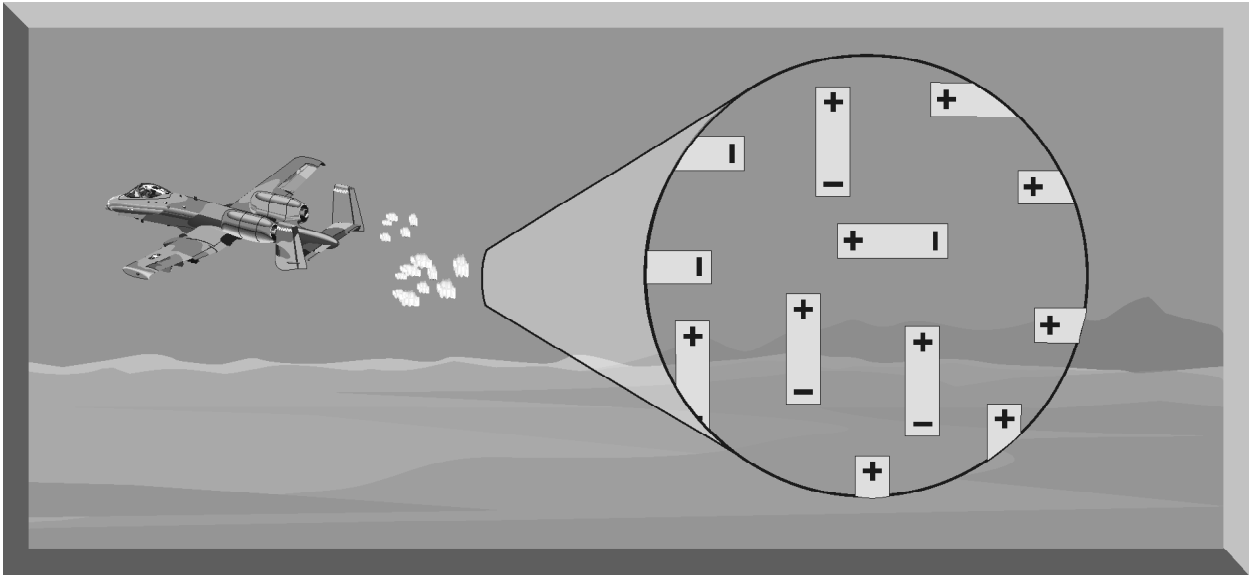

Figure 13-10. Impact of Chaff Polarization

3. CHAFF OPERATIONAL EMPLOYMENT

The two primary chaff employment tactics are force screening and self-protection. Force screening tactics include area saturation and corridor operations. Self-protection tactics include the reactive employment of chaff to negate a potentially lethal engagement. Different chaff dispensing techniques are used for each employment tactic and are important planning considerations for all chaff employment tactics. This section will discuss area saturation, corridor operations, and self-protection chaff employment.

a. The objective of area saturation operations is to present multiple false targets in a specific area in order to saturate radar systems and confuse the enemy integrated air defense system (IADS). Area saturation can be accomplished by fighter aircraft or drones equipped with chaff pods employing random chaff dispensing techniques. The chaff dispenser is set to release random bursts of chaff along the ingress and egress route of the attack package. Chaff pods may be supplemented with chaff bombs containing special fuses that provide false targets at varying altitudes. Attack aircraft can also contribute to area saturation by randomly dispensing self-protection chaff as they ingress and egress. However, this tactic can deplete the number of chaff bundles an attack aircraft may need to defeat a potentially lethal radar system encountered at a later time in the mission.

(1) The chaff cuts must provide frequency coverage for the threat radar systems. Also the RCS of each chaff burst should be large enough to present a realistic target to the victim radars. Multiple false targets created by chaff area saturation may confuse threat system operators and encourage them to expend missiles on false chaff targets.

(2) Saturation also masks the number of attacking aircraft (Figure 13-11). When used with false target deception jamming, area saturation can greatly enhance mission success. However, the technique is resource-intensive since aircraft employing chaff pods and chaff bombs cannot attack targets. These aircraft are vulnerable to attack and should be supported by standoff jamming. Area saturation tactics may have limited success against Doppler processing radars.



Figure 13-11. Area Saturation Tactics

b. The objective of chaff corridor operations is to screen the ingress and egress of an attack package by dispensing large quantities of chaff in a continuous “ribbon.” Fighter aircraft, or drones equipped with chaff pods such as the ALE-38, employ a stream chaff dispensing technique to “lay” the chaff corridor. The pods are set to provide a continuous line of chaff dense enough to hide ingressing and egressing aircraft. The chaff cuts should provide frequency coverage for the radar systems that must be countered. Timing for the chaff aircraft in relation to the attack package must consider the fall rate and persistency of the chaff to ensure that the chaff corridor covers the required altitude for a time sufficient to allow the attack package to ingress and egress. An effective chaff corridor completely denies a radar's ability to distinguish between

the chaff and the attack aircraft. To do this, the radar cross section, or RCS, of the chaff within the resolution cell of the radar must exceed the RCS of the aircraft. This condition must be met throughout the length of the chaff corridor. When this condition is met, the chaff corridor will appear as a continuous return on the victim radar scope, and the attack package cannot be detected (Figure 13-12).

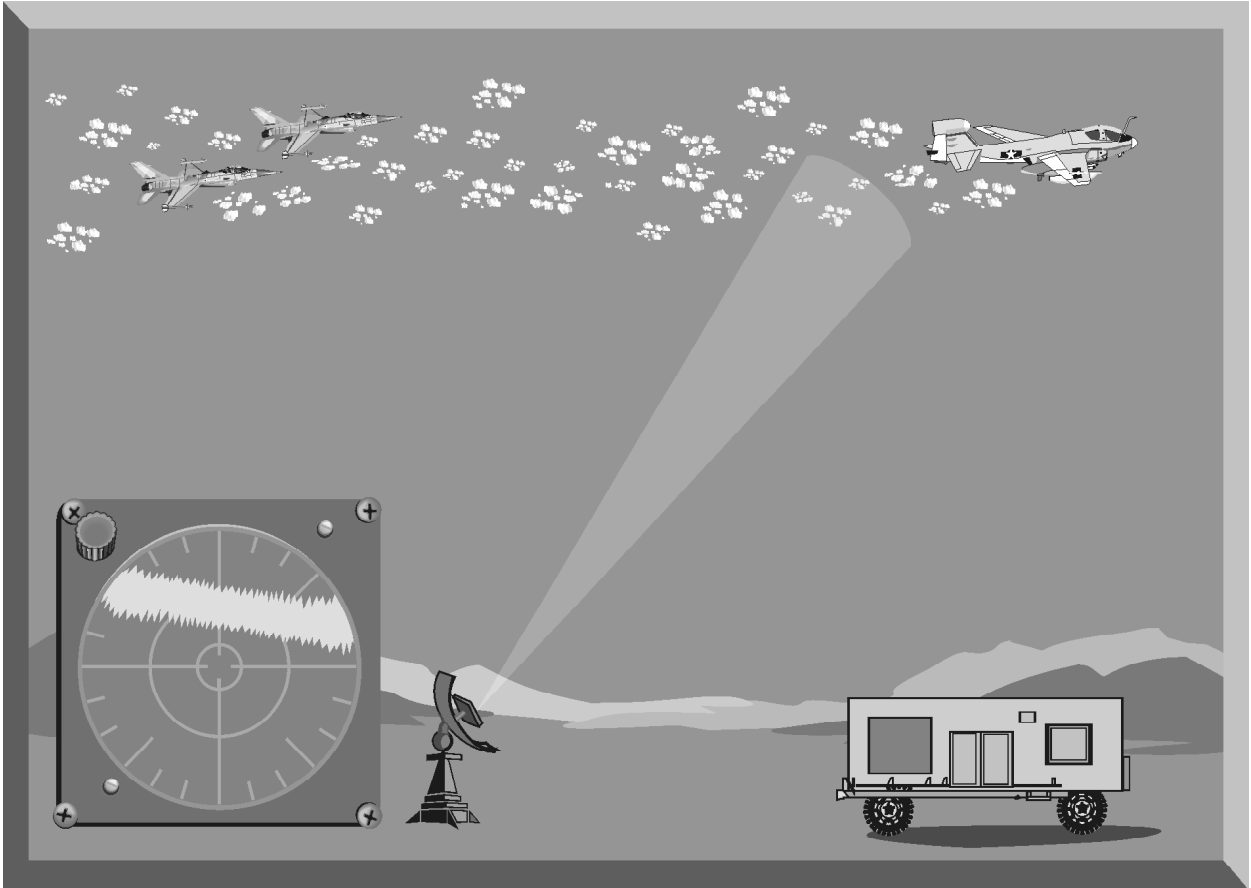

Figure 13-12. Chaff Corridor Tactics

(1) One advantage of a chaff corridor is that it can screen ingressing and egressing aircraft from pulse radar systems. However, chaff corridors are resource-intensive. Aircraft “laying” the corridor cannot strike critical targets. The chaff aircraft are also vulnerable to attack. Therefore, standoff jamming and self-protection jamming systems should be employed to provide some screening and protection for the chaff dispensing aircraft. Finally, chaff corridors may not be effective against radars with Doppler processing.

(2) To be effective, chaff corridor operations require detailed planning. Electronic combat (EC) planners must first determine that a chaff corridor is the most effective way to screen the attack force. This decision is based on the vulnerability of the attack aircraft to the anticipated threat radar systems and the availability of chaff assets. Once the decision is made to employ a chaff corridor,

planners must select the location, determine the length of the chaff corridor, select the ingress and egress altitudes, and establish the timing for the chaff aircraft and the attack package. Once the location of the chaff corridor is determined, planners must assess the threat radar systems that must be countered. The specific operating frequencies of the threat radars will determine the cuts of chaff that must be dispensed. The resolution cells of the threat radars will determine the density of chaff required. The length of the chaff corridor and the chaff density will determine the number of chaff aircraft required to seed the chaff corridor. The chaff fall rate and the atmospheric conditions impact the timing between the chaff aircraft and the attack package, and the altitude that the chaff dispensing aircraft must fly.

c. Self-protection chaff tactics are based on the use of chaff dispensers that use burst chaff dispensing techniques to defeat a TTR. Burst chaff dispensing, employed during the final phase of an engagement by air-to-air or surface-to-air weapons, can generate tracking errors or a radar break-lock. Burst chaff effectiveness is greatly enhanced when accompanied by jamming and evasive maneuvers (Figure 13-13).

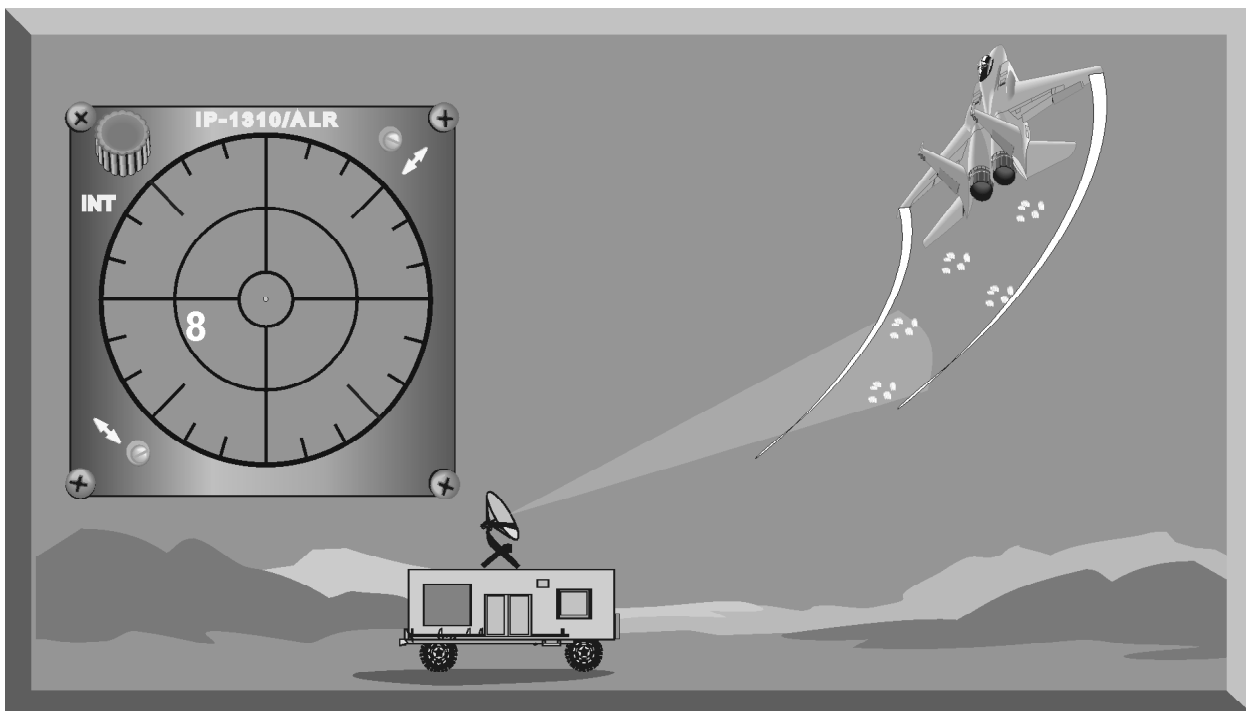

Figure 13-13. Self-Protection Chaff Tactics

(1) Self-protection chaff has proven effective against all pulse radar threat systems when employed with maneuvers and jamming. This is especially true for TTRs operating in an automatic tracking mode.

(a) Chaff employed against a track-while-scan (TWS) radar is designed to put multiple targets, with an RCS greater than the aircraft, in the resolution cell of the horizontal and vertical radar beams (Figure 13-14). Since the tracking loop tracks the largest return, the TWS radar will automatically switch to the chaff. After dispensing chaff, the pilot can maneuver vertically or horizontally to move the aircraft out of the resolution cell.

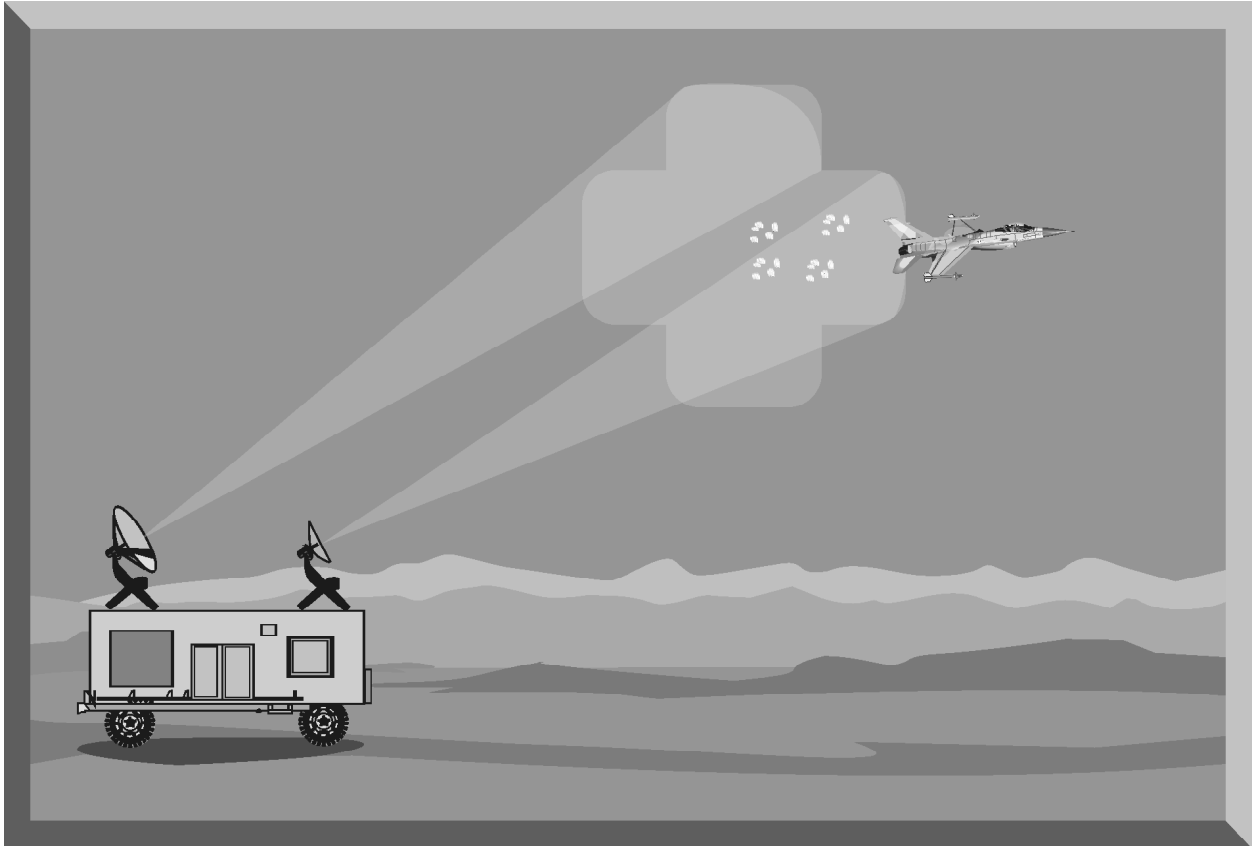

Figure 13-14. Self-Protection Chaff Effect on a TWS Radar

(b) Against a conical scan radar, chaff puts multiple, large RCS targets within the separate scans of the radar (Figure 13-15). These multiple targets generate error signals in the tracking loop and drive the separate scans off the aircraft return. As the conical scan radar tracking loop attempts to resolve these error signals, it will eventually lock on to the chaff. Maneuvering outside the overlapping scan area enhances chaff effectiveness and facilitates the transfer of radar lock-on to the chaff.

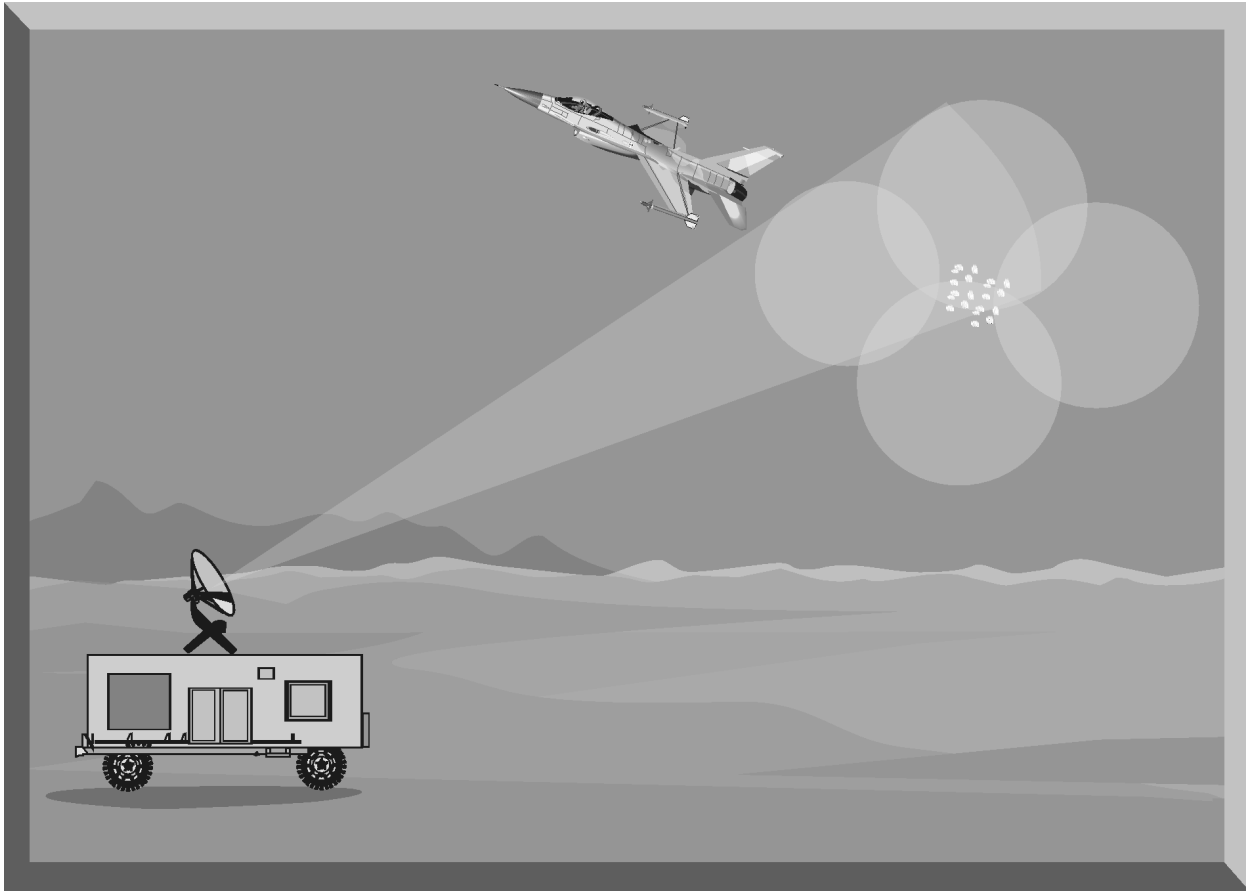

Figure 13-15. Self-Protection Chaff Impact on a Conical Scan Radar

(c) Chaff employed against a monopulse radar is designed to put multiple targets in at least two of the tracking beams (Figure 13-16). This generates errors in the azimuth, elevation, and range tracking circuits. Multiple chaff targets continue to generate azimuth and elevation errors that can eventually generate a break-lock condition, as the radar transfers lock-on to the chaff. Chaff is most effective against monopulse radars when employed on the beam in order to create the maximum angular tracking error.

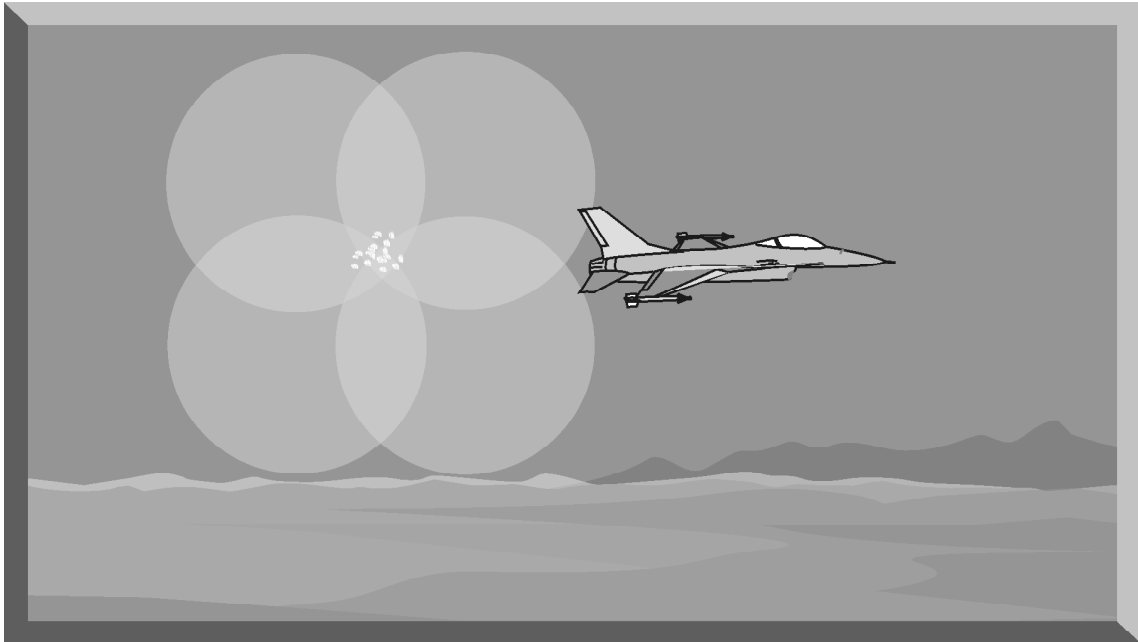

Figure 13-16. Self-Protection Chaff Impact on a Monopulse Radar

(d) Modern radars may employ some form of Doppler filtering to negate the effectiveness of chaff and other sources of clutter. Pulse Doppler and continuous wave radar systems track targets based on target velocity relative to the radar. Radars employing a moving target indicator (MTI) use relative target velocity to distinguish between targets and clutter. Chaff slows to near zero relative velocity almost immediately after dispensing. For self-protection chaff to be effective, the aircraft velocity relative to the radar site must also be near zero. This occurs when the aircraft's aspect to the radar is 90° , or on the beam. By maneuvering to a beam aspect against a Doppler radar, the pilot is exploiting the "notch" where radar cannot discriminate targets based on Doppler frequency shift (Figure 13-17).

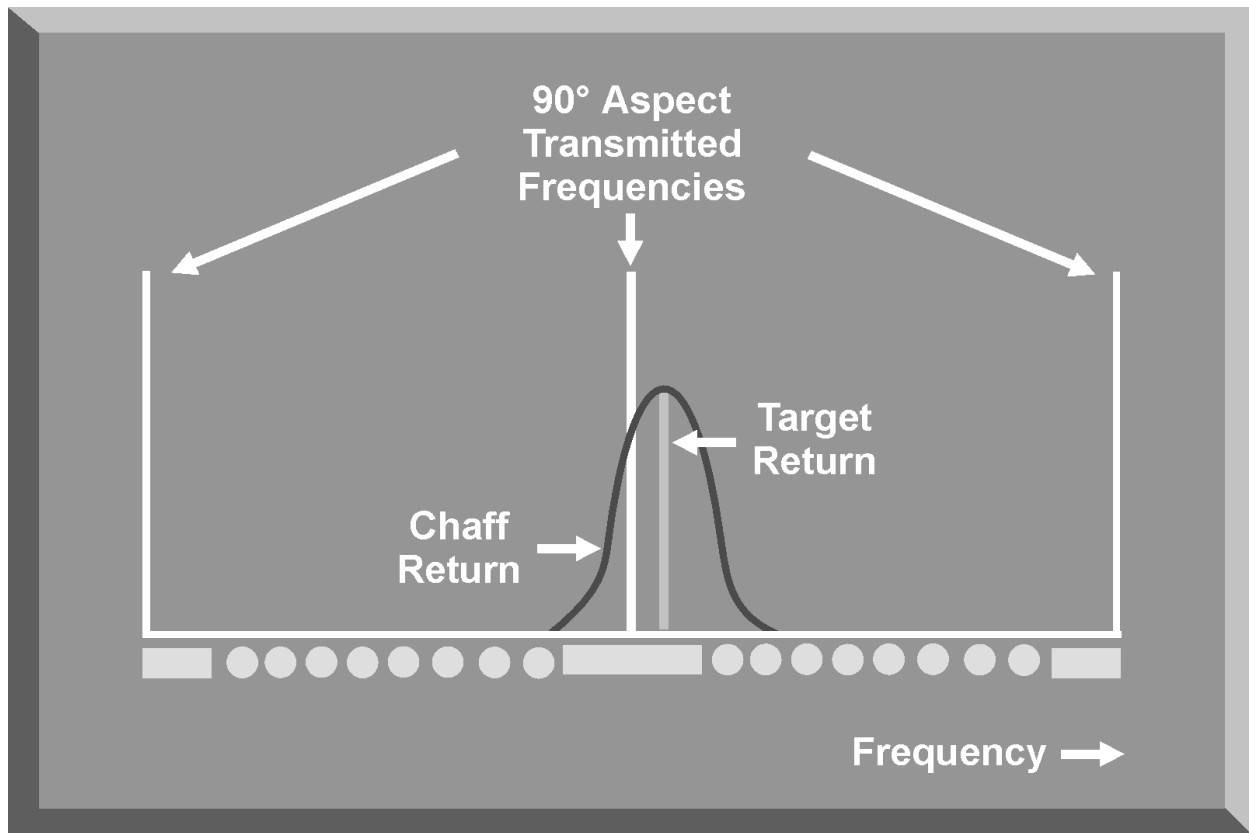

Figure 13-17. Self-Protection Chaff Impact on a Doppler Radar

4. SUMMARY

Chaff is one of the oldest and most effective pulse radar countermeasures. The fundamental characteristics of chaff (RCS, frequency coverage, bloom rate, Doppler content, polarization, and persistence) determine the effectiveness of chaff employment. The primary chaff employment tactics of force screening and self-protection are designed to maximize the impact of chaff on threat radar systems. Self-protection chaff, together with jamming and maneuvers, is often the “last line of defense” against lethal radar threat systems.

CHAPTER 14. IR FUNDAMENTALS

1. INTRODUCTION

Since their introduction in the 1950s, infrared (IR) missiles have been an increasing threat from both ground-based and airborne systems. The range, reliability, and effectiveness of IR missiles have been continuously improved by advanced detector materials and computer technology. Since IR missiles are passive, they are relatively simple and inexpensive to produce. These characteristics have contributed to the proliferation of IR missiles in the combat arena. Nearly every aircraft flying in either the air-to-air or air-to-surface role now carries an all-aspect IR missile. Additionally, every infantry unit down to the platoon level is equipped with shoulder-fired IR missiles (Figure 14-1). This chapter will cover basic IR theory, IR missile detection, IR seekers, and conclude with a section on IR flare rejection.

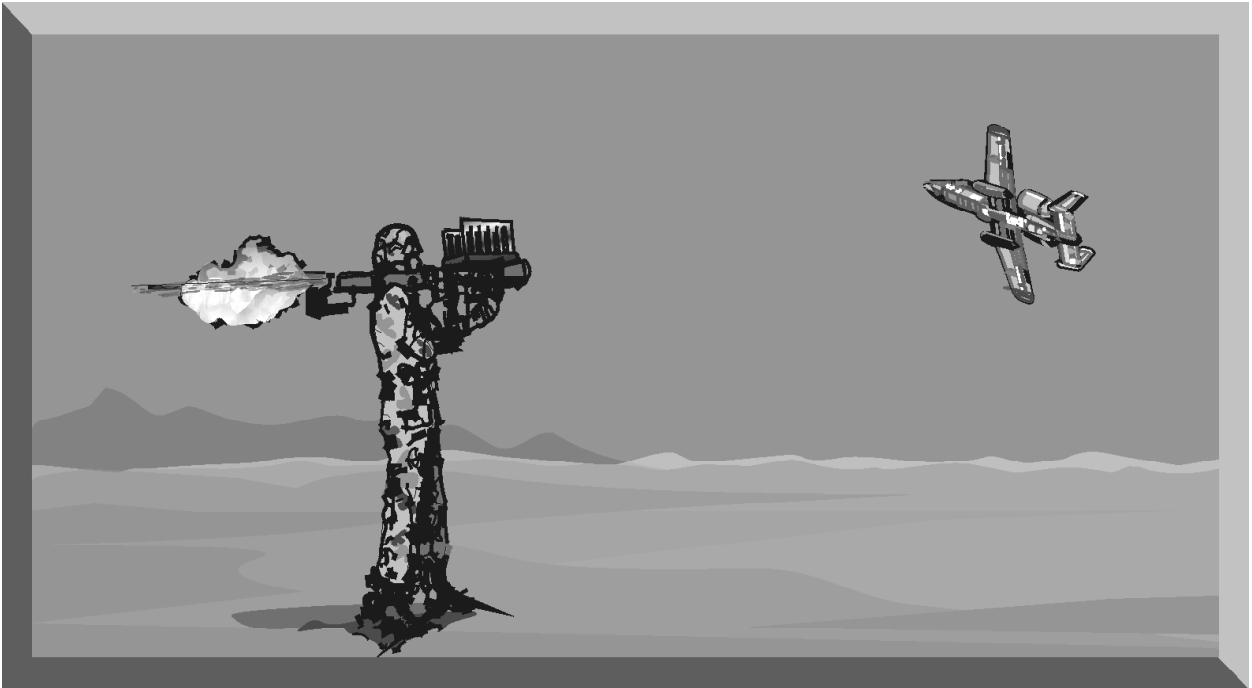

Figure 14-1. The IR Threat

2. BASIC IR THEORY

Because of its location in the frequency spectrum, IR radiation exhibits some of the characteristics and limitations of microwaves and visible light.

a. All warm objects emit IR energy. The object's temperature dictates the characteristics of this radiation. As the temperature of the material increases, the radiant intensity increases and shifts to shorter and shorter wavelengths or

higher and higher frequencies. The frequency band of IR radiation falls between the upper limit of microwaves and the lower limit of visible light. When discussing IR radiation, it is more convenient to refer to wavelength instead of frequency (Figure 14-2). The wavelength of the highest frequency IR is 0.72×10^{-6} meters. A unit of measure called the micron (μ), is one millionth, or 10^{-6} , of a meter and is used to designate IR wavelengths. IR energy falls in the electromagnetic spectrum between the wavelengths of 1000 and 0.72 microns, while visible light occupies the spectrum from 0.72 to 0.39 microns.

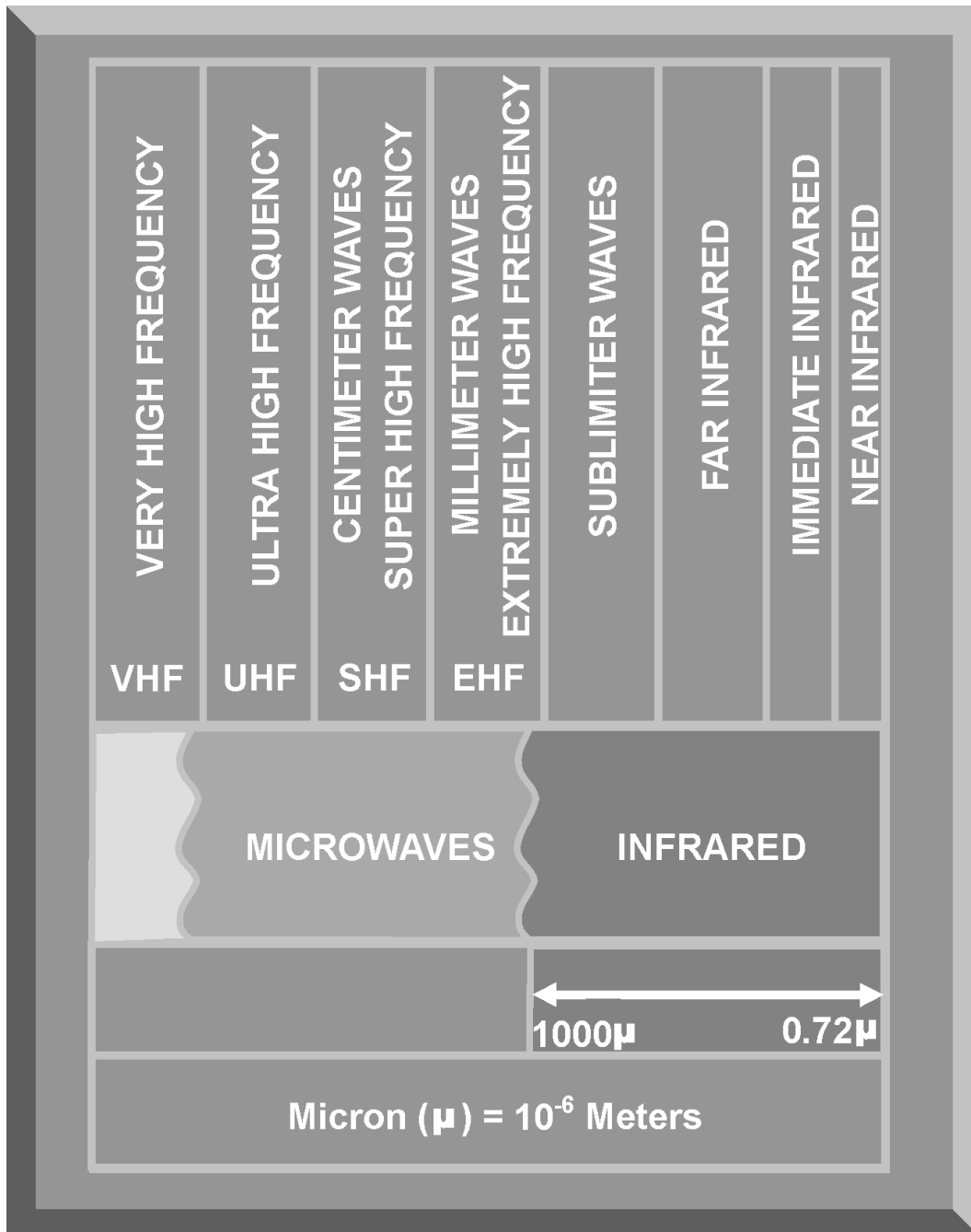

Figure 14-2. IR Frequency Band

b. As the IR energy travels through the atmosphere, certain wavelengths are absorbed or attenuated. The greatest IR attenuator is atmospheric water vapor, which varies as the weather conditions vary, with negligible absorption at altitudes above 30,000 feet. Another significant attenuator is carbon dioxide. The percentage of carbon dioxide in the atmosphere is practically constant up to a height of 30 miles. Carbon dioxide absorption is predictable and occurs only in the IR region. Scattering is another form of atmospheric attenuation and is caused by dust particles and water droplets. Scattering is also largely dependent on weather conditions and cannot be predicted. Most of the scattering occurs at lower altitudes and at the shorter wavelengths. Other atmospheric elements cause little or no attenuation of IR energy. Figure 14-3 shows atmospheric IR transmission at sea level. There is a relatively large window of IR transmission in the region from one to five microns. This is the region where the aircraft engine heat signature is at its maximum intensity and where most IR missiles are designed to operate.

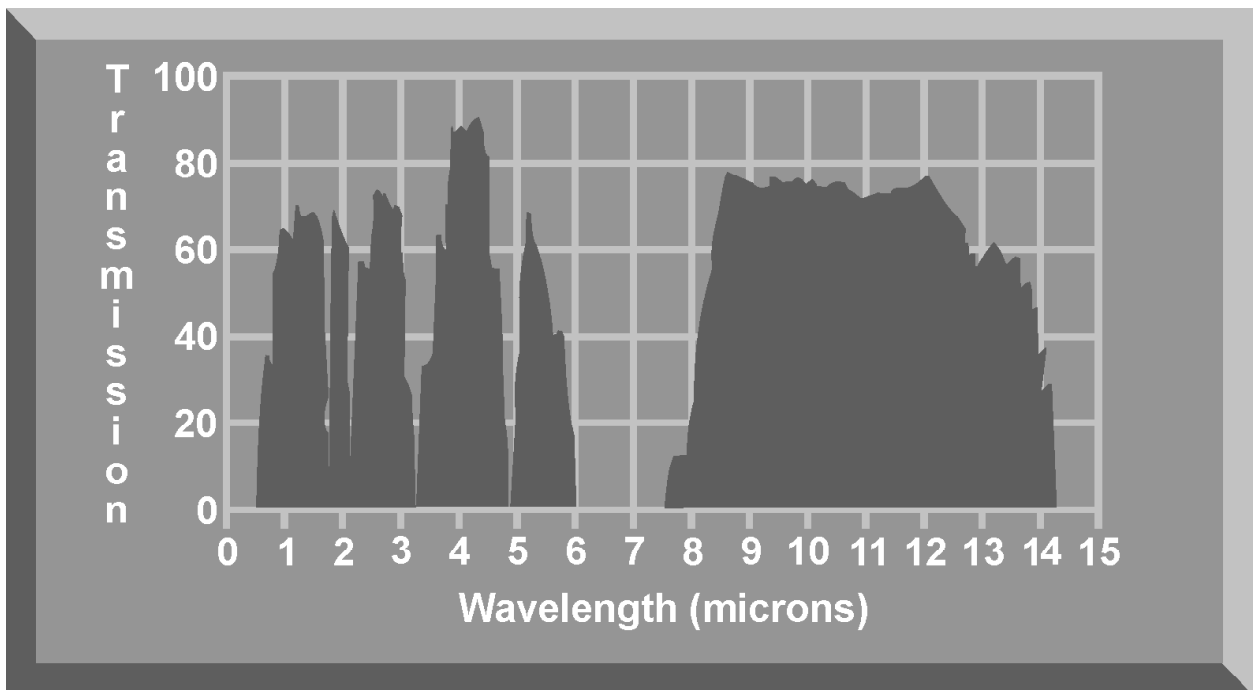

Figure 14-3. Atmospheric IR Transmission

c. IR energy exhibits some of the transmission characteristics of both RF energy and visible light. As with visible light, it can be optically focused by lenses and mirrors. This characteristic is used in the IR missile detector elements (Figure 14-4). As with RF energy, the intensity of IR radiation diminishes inversely with the square of the distance between the source and the receiver.

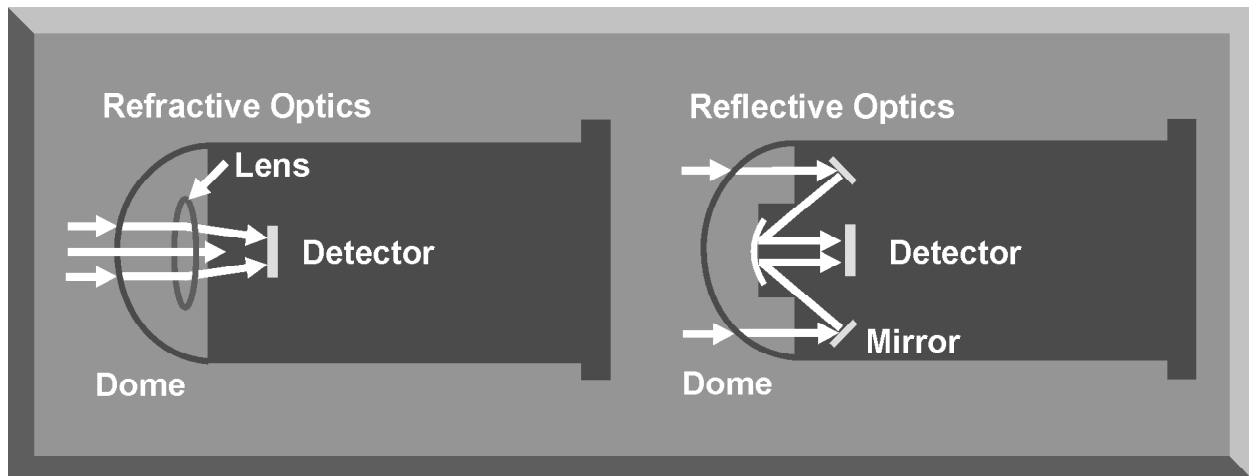

Figure 14-4. IR Missile Seeker

d. If the intensity of the aircraft's IR signature, while in the military power setting, is plotted in relation to wavelength, it reaches a peak at approximately 3 microns (Figure 14-5). In afterburner, the aircraft's IR intensity reaches a peak at approximately 1.5 microns. Since IR missiles are designed to detect and track the aircraft's IR signature, most IR missiles operate in the region of 1 to 5 microns. To be effective, the IR intensity of a flare must also fall within this micron region.

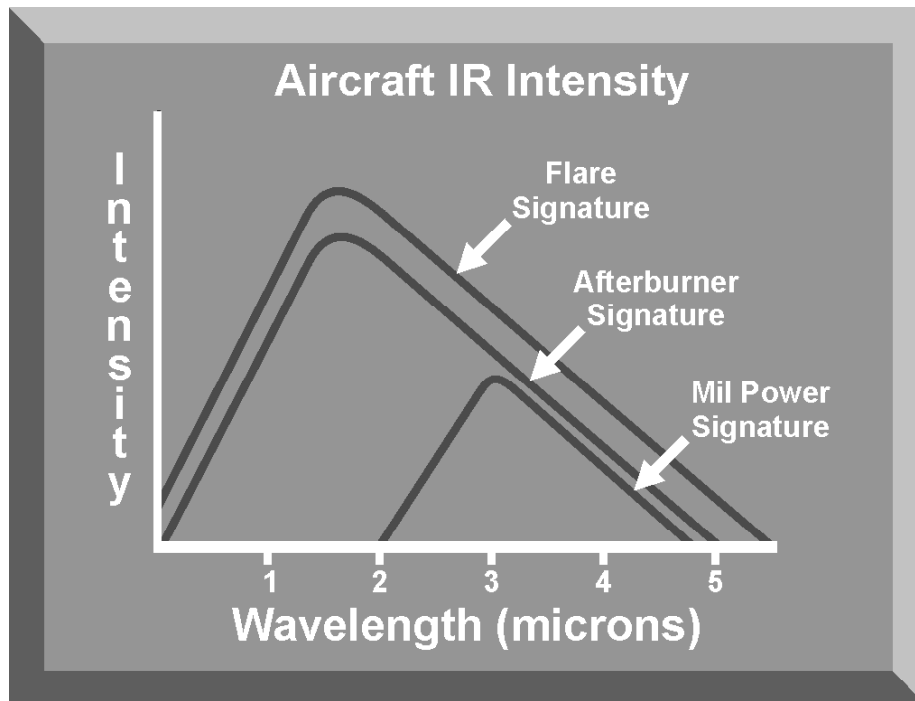

Figure 14-5. Aircraft IR Intensity

e. An aircraft's relative IR signature is based on aspect angle, airspeed, altitude, and afterburner status. The minimum relative IR intensity is at the nose and maximum at the tail. As airspeed increases, the relative IR intensity increases due to the heat generated by friction and increased engine temperatures. As altitude increases, the relative IR signature increases at all aspect angles, due to the reduction in atmospheric attenuation (Figure 14-6).

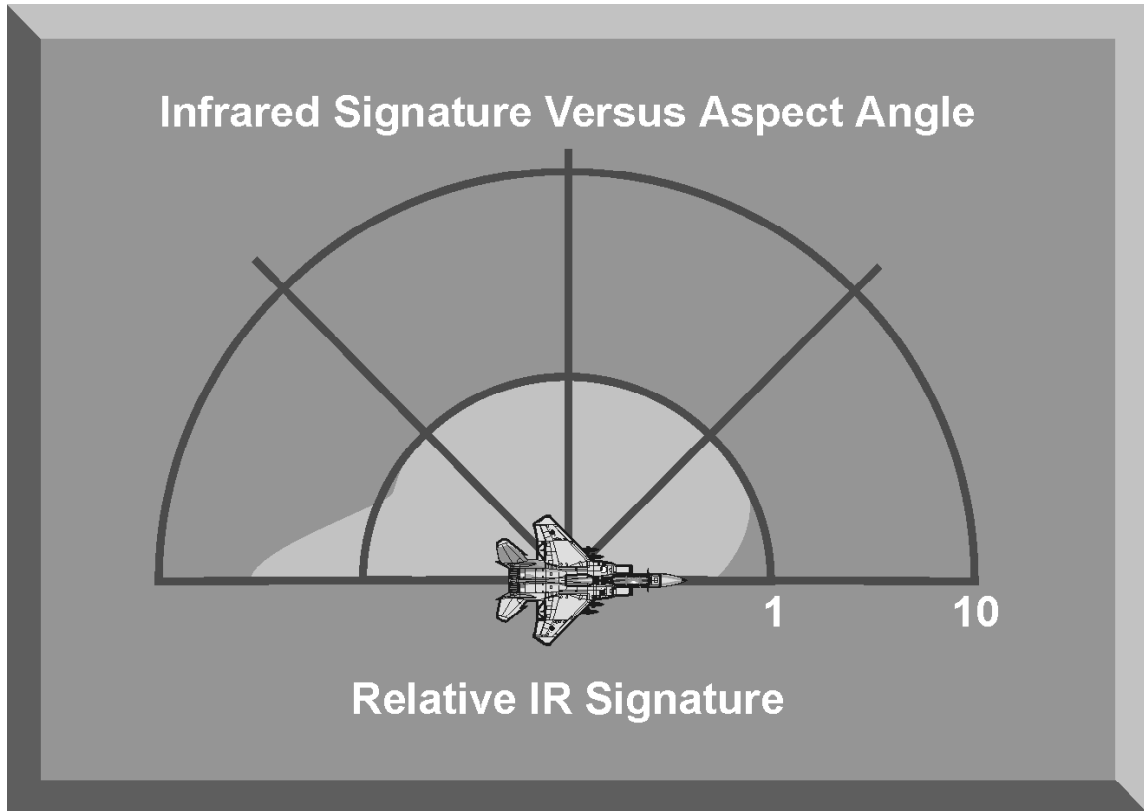

Figure 14-6. IR Signature Versus Aspect Angle

3. IR SIGNATURE SOURCES

IR guidance is based on the fact that every object with a temperature above zero degrees Kelvin emits IR radiation. The temperature of the object dictates the characteristics of this radiation. As the temperature of the object increases, the radiant intensity increases and shifts to higher and higher frequencies and correspondingly shorter and shorter wavelengths. The F-16 at Figure 14-7 demonstrates the different wavelengths found at different areas of the aircraft. Emissivity in Figure 14-7 is a relative measure of the IR energy emitted when a surface is directly viewed.

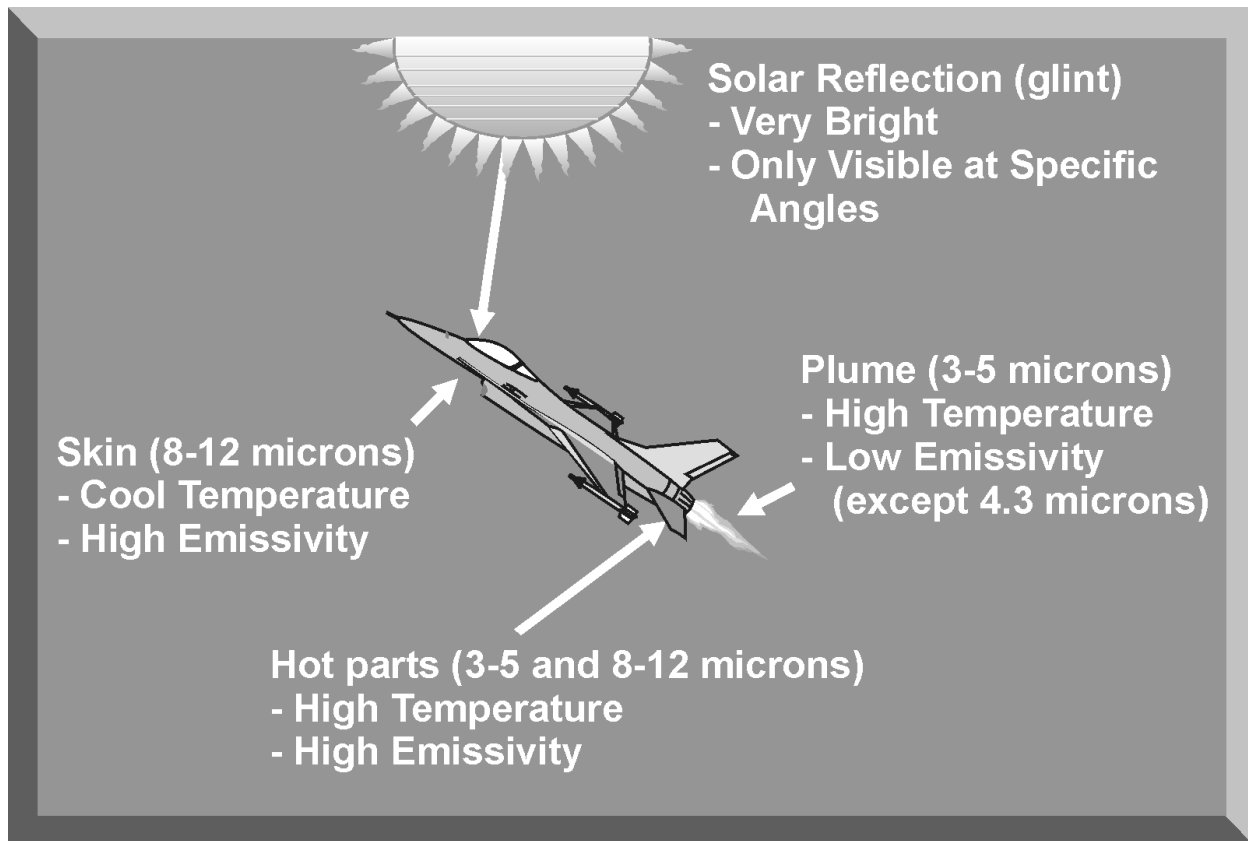

Figure 14-7. Target Signature Sources

a. The main aircraft signature sources are the plume, the engine hot parts, and the skin. The skin is large in area, but usually fairly cool. Thus the best detection of the aircraft skin is usually in the long wave IR band (8-12 microns).

b. The engine hot parts offer excellent detection when one is looking at the right angle. They have high temperatures and high emissivity. However, depending on the viewing angle, they may have a low perceived area.

c. The plume has high temperatures and a high perceived area. This large perceived area allows near all-aspect detection. Unfortunately, it has a relatively low emissivity except near 4.2 microns. It is the strategy of the new breed of all-aspect missiles to detect the plume in the mid-wave IR, around 4.2 microns.

d. Figure 14-8 shows some of the common IR detector materials. Note that the cooled detectors are sensitive to longer wavelength (lower energy) photons, as discussed earlier.

Material	Wave-Band
Lead Sulfide (PbS) - Uncooled	1.5 - 2.5 micrometers
Lead Sulfide (PbS) - Cooled	2.0 - 4.0 micrometers
Lead Selenide (PbSe) - Uncooled	2.0 - 4.2 micrometers
Lead Selenide (PbSe) - Cooled	3.0 - 5.0 micrometers
Indium Antimonide (InSb) - Cooled	2.0 - 5.0 micrometers
Mercury-Cadmium-Telluride (Hg _(1-x) Cd _(x) Te) - Cooled	8.0 - 13.0 micrometers

Figure 14-8. IR Detection Materials

4. IR SEEKER CHARACTERISTICS

Guidance units are designed to detect and home in on the IR radiation of the aircraft. The job of the seeker is to view the scene and output the estimated target position. Figure 14-9 shows the hardware that makes up the seeker of a generic IR missile system.

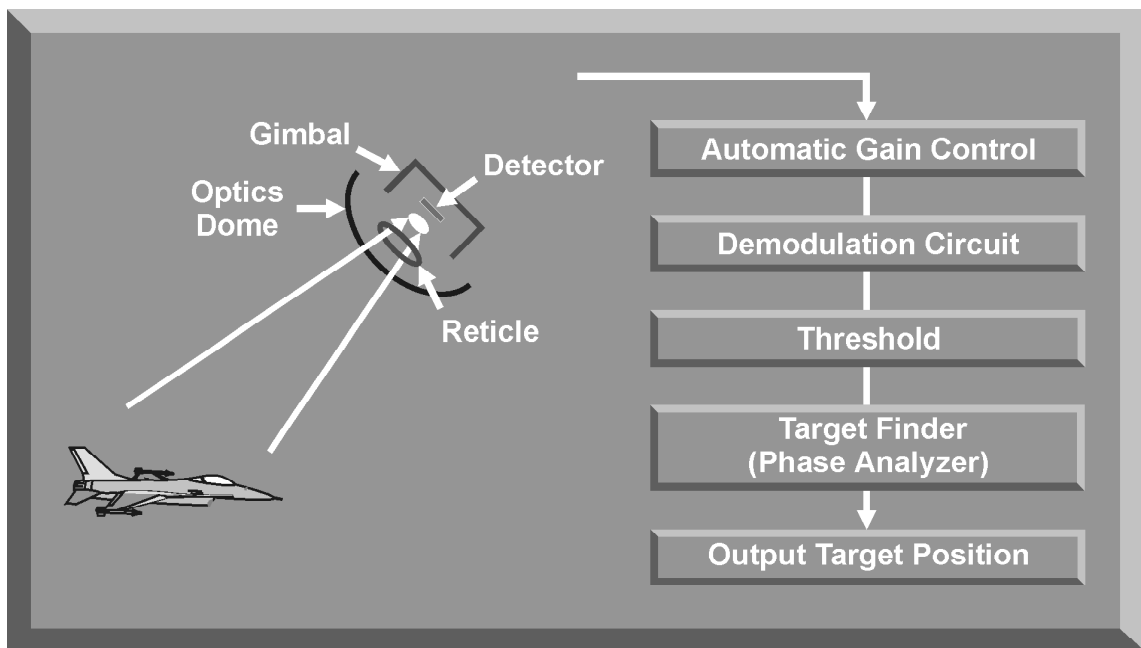

Figure 14-9. IR Missile Seeker

a. The dome acts as an IR transparent protective cover. Most IR missiles use the hemispherical dome because that shape does not alter the path of the incoming light rays. The optics focus the scene through the reticle onto the detector. The reticle pattern enables the detector output to “code” the position of the target.

b. The internal workings of the missile are similar to those found in a radar tracking system. There is an automatic gain control (AGC) to adjust the levels of the detector output so that it is not too large or too small. The demodulation circuit “decodes” the detector signal. The threshold circuit cancels signals that are below the specified threshold value, similar to the clutter rejection function found in radar systems. Finally, the phase analyzer reads the target position from the signal and sends the result to the autopilot. The autopilot then adjusts the missile’s flight path to track the target.

c. IR systems employ filters and detectors to filter out unwanted IR radiation from the sun, sunlit clouds, smoke, the earth, and other background radiation sources (Figure 14-10). The detection unit is coupled with a guidance system to generate commands to the missile control vanes to keep the target centered in the field of view.

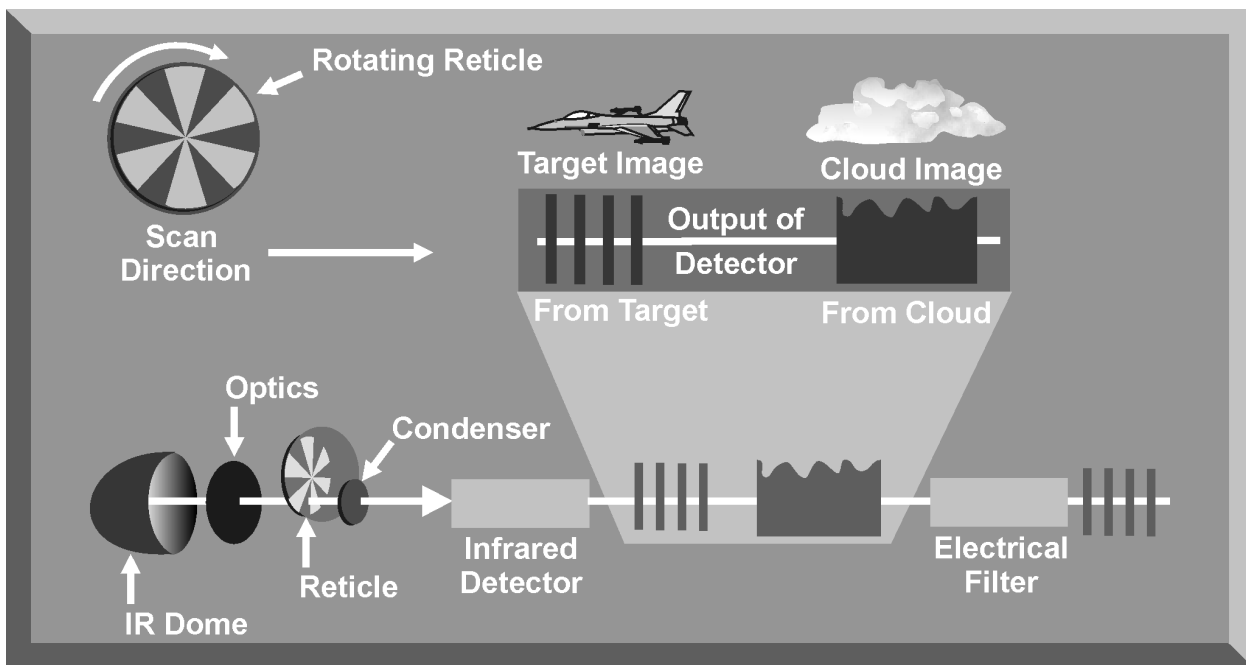

Figure 14-10. Spin Scan Reticle

d. A defining characteristic of an IR missile is its field of view (FOV) and field of regard (FOR) (Figure 14-11). The angular size of the image in degrees is called the field of view. To provide the greatest possibility of collecting IR radiation from the target, the receiver must have the greatest possible FOV. This in turn may

create problems. A large FOV increases the possibility that the receiver may not be able to distinguish the target from other sources of IR radiation. To avoid this problem, a relatively small FOV is scanned through a wider area. This wider area is referred to as the FOR. The gimbal enables the FOV to be scanned, so that an entire FOR can be searched.

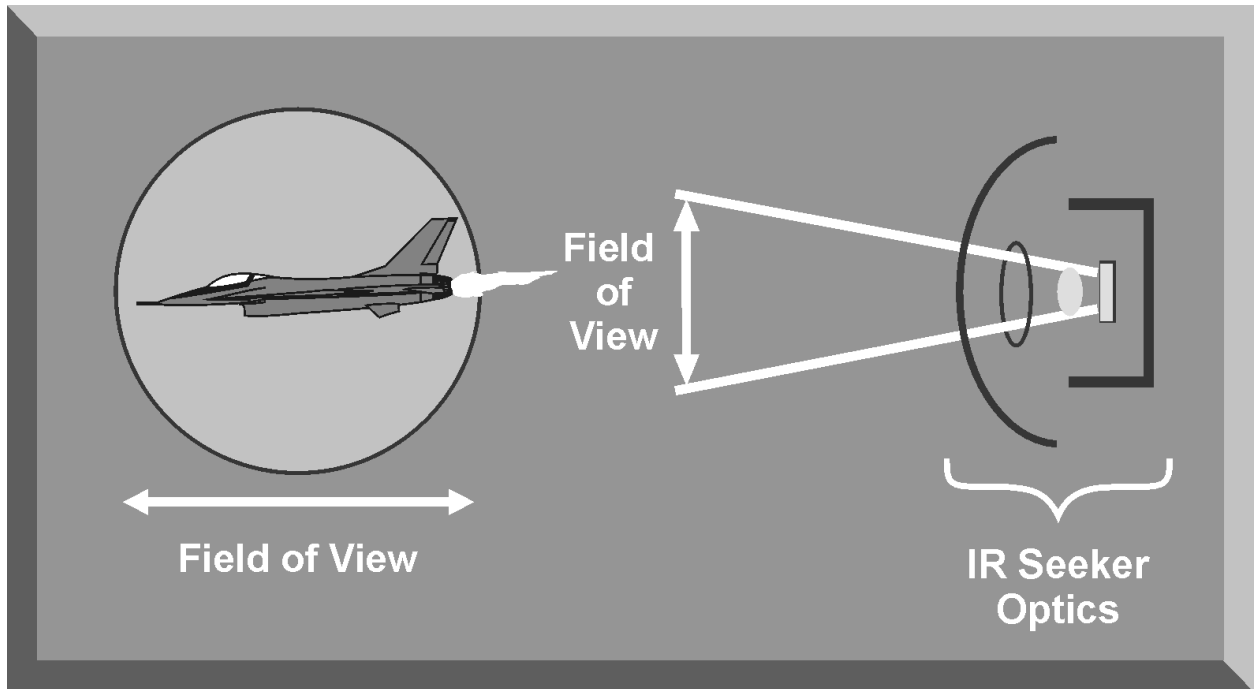

Figure 14-11. Missile Field of View

5. IR SEEKER TYPES

Through the years advances in seeker technology have resulted in significant changes to IR missile engagement tactics. This section will discuss spinning reticle, conical scan, cooled, and imaging IR seekers.

a. First generation IR missiles, like the SA-7, use a spinning reticle as the means to track the target. Due to their relatively low cost and ease of use, IR missiles of the first generation can still be encountered. The spinning reticle is inserted in the seeker just before the IR radiation reaches the detector. The reticle is a thin plate of optical material which has a transparent and opaque pattern on it. As the reticle is rotated, the IR energy is chopped at a rate determined by the reticle pattern. This system produces error signals when the target is not exactly centered in the field of view. Figure 14-12 is an example of a reticle pattern that can provide both azimuth and elevation information. If the target is located in the upper half of the pattern, the IR intensity on the detector is constant as the reticle rotates. As the pie-shaped half of the disc rotates over the target, the IR energy is pulsed and the amplitude of the pulses is an indication of relative elevation angle.

When the target moves to the right or left, the pulsing starts and stops at different times, indicating target azimuth. Center spun spin-scan seekers, also called center null reticles, are relatively insensitive when the target is in the center of the seeker scan where there is no tracking error. This is because the point target tends to bleed energy into all the spokes at once, eliminating the pulsed signal output of the detector. Once the target falls off the center of the reticle, the seeker generates an error signal that initiates guidance commands to recenter the target. This is the reason early IR missiles flew an undulating path toward the target.

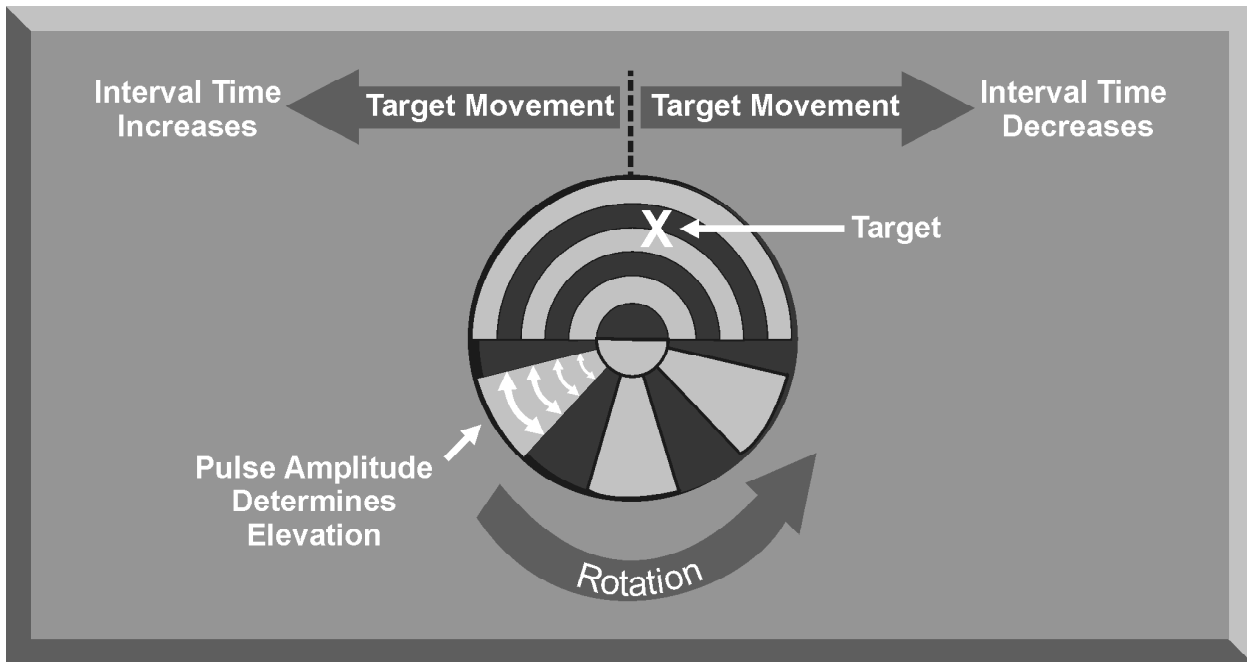

Figure 14-12. IR Missile Reticle

b. IR conical-scan (con-scan) seekers were developed to solve some of the problems with spin-scan seekers; notably the lack of error response when the target is near the center of the seeker field of view (FOV) (Figure 14-13). In a typical con-scan seeker, the reticle is fixed and does not spin. Instead, a secondary mirror is tilted and spun. This causes the target image to be scanned in a circular path around the outer edge of the reticle. When the target is centered in the seeker scan, the detector generates a pulsed output similar to that of the spin-scan seeker. However, as the target leaves the center, the output of the detector is a frequency modulated (FM) sine wave. The frequency of the modulation is directly proportional to the amount of target displacement from the center of the seeker scan. Con-scan optics are usually designed to spin the target very close to the edge of the reticle. This generates the greatest amount of FM modulation for a given target tracking error and gives the con-scan IR missile a more sensitive and tighter tracking loop. The center of the reticle is only used for acquisition.

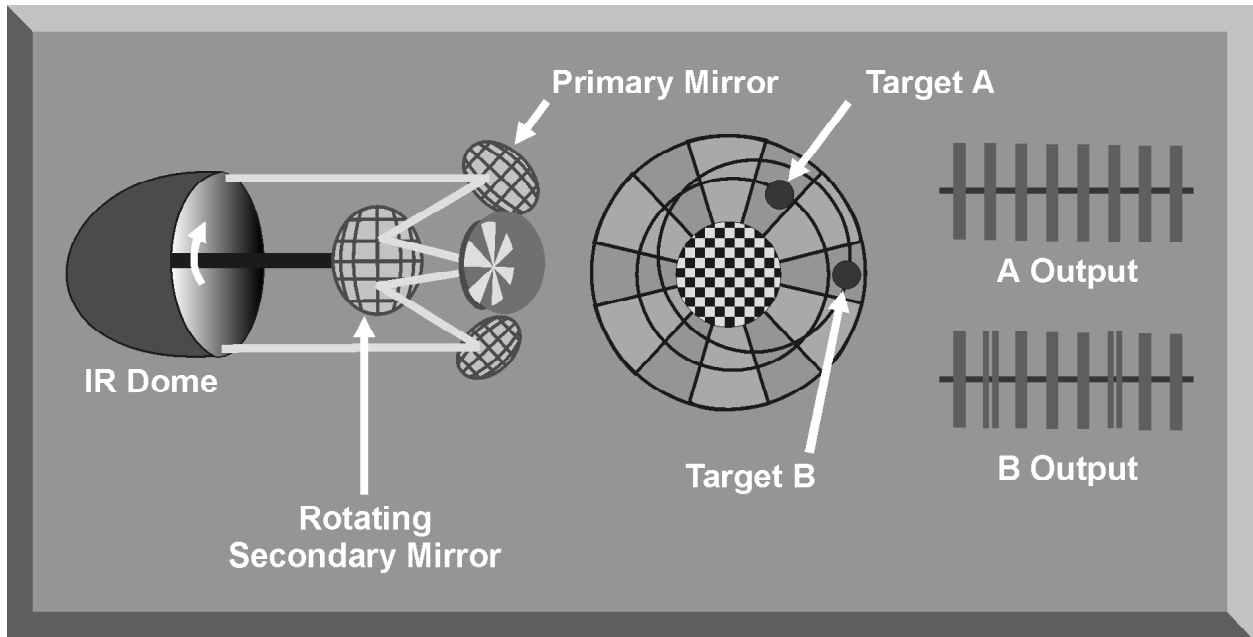

Figure 14-13. Conical Scan IR Seeker

c. A significant improvement to IR seekers resulted from the cooling of the detector with an inert gas such as argon. Older IR missiles, using uncooled lead-sulfide detectors, have a peak sensitivity in the 2 micron region. This limits these missiles, the SA-7 for example, to stern attacks because the missiles can only discriminate the IR signature of the engine turbine from background IR energy. By cooling the detector with an inert gas, like argon, the detectors of newer IR missiles can track longer wavelength IR radiation associated with airframe friction. Using newer detector materials like indium antimonide (InSb), require cooling to have increased target detection range and all-aspect tracking capability.

d. Imaging IR is the most recent advancement in IR seeker technology. The technology for these seekers is similar to that found in the AGM-65 Maverick missile. Imaging IR seekers are harder to decoy with flares than older seekers, and they are resistant to pulsed light jamming. Imaging detection involves creating an IR picture of the scene in one of two ways, scanning or staring. A scanning system uses one detector (or a mix of detectors and mirrors) which moves relative to the scene until the entire scene is scanned. This is an easy system to fabricate, but it can be noisy because the detector can't stay very long at each position, and it does not have a lot of time to measure the signal. A staring system uses many detectors, each of which detects a small portion of the scene. Each detector can "dwell" on its part of the scene for the entire frame time. However, such systems, also called focal plane arrays, are difficult to fabricate in a way such that each detector has the same sensitivity. One of the prime advantages with using imaging IR seekers is that they can be programmed

to track a particular IR shape or scene, significantly reducing the effectiveness of decoy flares.

6. IR MISSILE FLARE REJECTION

Flares are the primary countermeasure used to defeat the IR missile. Advanced IR missiles use different techniques to overcome the use of self-protection flares. There are two important characteristics of infrared (IR) missiles that influence the effectiveness of self-protection flares. The first is the ability of the IR missile seeker to discriminate between the IR signature of the aircraft and the IR signature of background interference, especially clouds. The second is the flare rejection capability built into the missile seeker and the missile guidance section.

a. The major source of IR background interference is sunlit clouds. Space filtering using a spinning reticle as described in the previous section is the method most widely used to suppress background interference and improve discrimination. IR energy from the target is gathered by the optical system and focused on the spinning reticle. The reticle chops the signal into a series of pulses that are focused onto the IR detector element. The signal output of a point source of IR energy, such as a target aircraft, will be a series of pulses. The signal output of a cloud, which covers several segments of the reticle, will be a single large pulse. An electrical filter eliminates the single large cloud pulse, and passes the multiple pulses generated by the target to the missile guidance section.

(1) IR missiles using spin-scan seekers have very little ability to reject flares. Flares provide the missile seeker with a hotter target than that of the aircraft, causing the spin-scan seeker to track the flare. The typical flare burns with a peak energy emission in the 2 micron range. Since the flare energy emission is greater than that of the target aircraft, the missile seeker transfers lock to the flare.

(2) Due to the scan pattern, con-scan seekers have some inherent resistance to flares. As described in the previous section, the reticle in a con-scan seeker is fixed and does not spin. Instead, a secondary mirror is tilted and spun. This causes the target image to be scanned in a circular path around the outer edge of the reticle. Because flares tend to drop away from the aircraft, they will drop off the con-scan reticle much faster than for a spin-scan reticle; therefore, flare resistance is built-in.

(3) Reducing the missile FOV is another method to help an IR missile discriminate the target IR signature from background IR (Figure 14-14). Limiting the FOV of the missile also makes the missile more resistant to flares. To decoy an IR missile seeker, the flare must create a heat source hotter than the aircraft and within the missile FOV. To decoy an IR missile with a narrow FOV, the flare must reach peak intensity almost immediately after ejection (Figure 14-15).

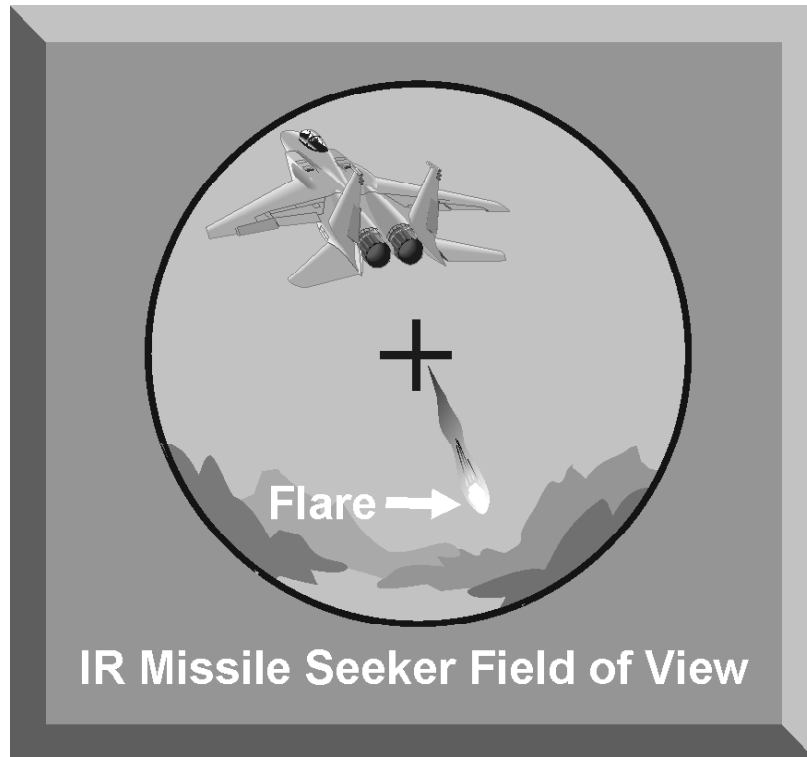

Figure 14-14. Impact of IR Missile Field of View



Figure 14-15. IR Missile – Narrow Field of View

(4) The detector also influences the ability of an IR missile to discriminate target IR from background IR. Newer IR seekers can track longer wavelength IR radiation. The seeker's ability to track through a wider frequency range forces flares to decoy that wider frequency range to be successful. Additionally, the cooled seeker's ability to track from all angles could cause geometry problems, the missile may never see a flare ejected from the bottom rear of an aircraft.

b. IR missile designers have combined computer signal processing and modern IR missile seekers to detect the presence of flares and reject them as targets. This flare rejection capability, or IR counter-countermeasure (IRCCM), allows newer IR missiles to track the aircraft IR signature while rejecting multiple flares. Flare rejection is based on two computer functions. The first is called the "trigger," which detects the flare in the seeker field of view. The "trigger" function activates the "response" computer processing, the action the seeker takes to reject the flare. Both the "trigger" and "response" must operate to successfully reject flares. Each advanced IR missile employs different computer techniques for both the "trigger" and "response." A flare technique developed to counter one IR missile may not work against another IR missile that uses different flare rejection computer techniques.

(1) There are several "trigger" techniques that can be used by IR missiles to detect flares. Advanced IR missiles may employ one or more of these techniques to detect the presence of a flare in the seeker FOV. These "trigger" techniques include rise time, two-color, kinematic, and spatial.

(a) An IR missile using a rise time "trigger" monitors the IR energy level of the target. A sharp rise in the received IR energy within a specified time limit indicates a flare in the IR seeker FOV. When the missile detects this rapid rise in IR energy, the rise-time "trigger" triggers a flare "response." The "response" is switched off when the received IR energy drops to its original level. The thresholds for the rise in IR energy and the response time are set to preclude activating the rise time "trigger" when the aircraft selects afterburner. An IR missile using the rise time "trigger" can be decoyed by multiple flares with slow rise times.

(b) IR missiles using a two-color "trigger" to detect flares sample the energy level in two different wavelength bands. In Figure 14-16, a non-afterburning target would have more IR intensity in band B than in band A. The typical flare produces more IR intensity in band A than band B. A sudden increase in band A intensity compared to band B intensity indicates a flare in the seeker FOV. The two-color "trigger" would then trigger a flare "response." Advanced IR missiles using a two-color "trigger" can employ different detectors composed of different materials to monitor the intensity in two bands. A lead sulfide detector could be used for band A and indium antimonide for band B. IR missiles using a single detector can employ a reticle with different bandpass filters to monitor IR intensity in both bands. To track the target, IR missiles employing a two-color "trigger" may use either band, or use data from both

bands of a dual-channel tracker. An IR missile using the two-color “trigger” can be decoyed by multiple flares that provide equal IR intensity in each band.

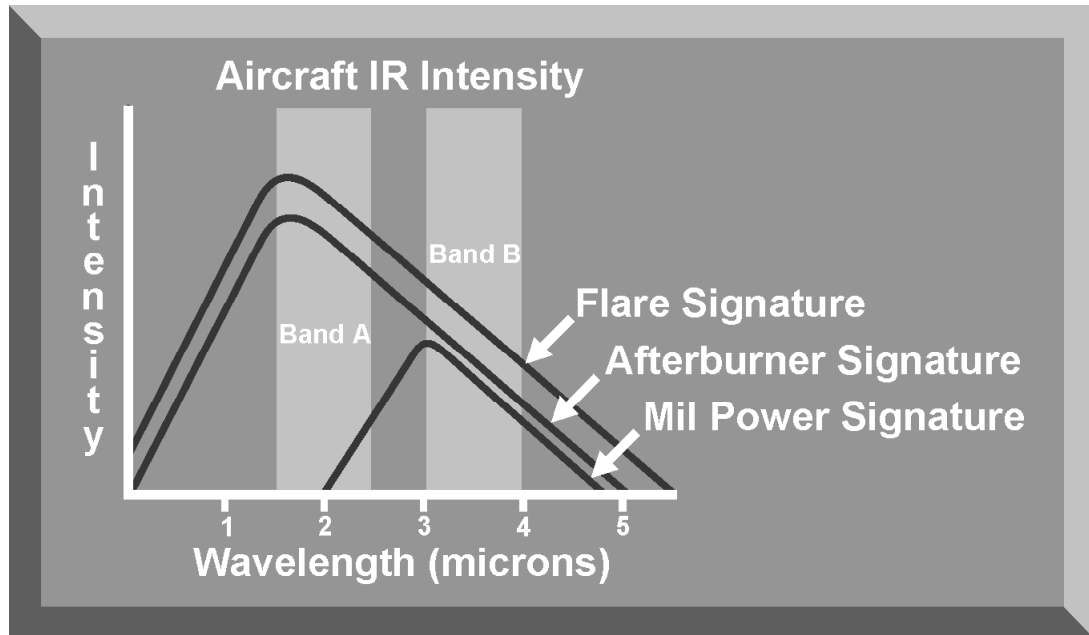

Figure 14-16. Two-Color IR “Trigger”

(c) A kinematic “trigger” takes advantage of the fact that flares separate very quickly from the dispensing aircraft due to aerodynamic drag. In a beam aspect engagement, an IR seeker that transfers track from the target to the flare will have a dramatic change in the line-of-sight rate due to the rapid separation of the flare from the aircraft. An IR missile employing a kinematic “trigger” detects this change and initiates the “response.” IR missiles employing a kinematic “trigger” may have difficulty in flare detection in a head-on or stern engagement due to the small line-of-sight change between target and flare. Multiple flares dispensed at very short intervals will probably decoy an IR missile employing a kinematic “trigger”.

(d) The spatial “trigger” operates like the kinematic “trigger” in that it uses the rapid separation of the flare from the aircraft to trigger the “response.” An IR missile employing a spatial “trigger” uses the seeker to detect a flare. When the flare separates to the rear of the aircraft, the seeker will see the target on the edge of the FOV corresponding to the direction of target movement. The flare will be on the opposite side of the FOV. Once two hot objects on opposite sides of the FOV are distinguishable, the spatial “trigger” triggers the flare “response.” IR missiles employing a spatial “trigger” can be decoyed by dispensing multiple flares at very short intervals.

(2) The seeker’s “response” to the “trigger” is to reject the flare or limit its effect on target track. As long as the flare remains in the seeker FOV, the missile

is tracking the target in a degraded mode. Most IR seekers have a FOV of less than 2.5° . At long ranges, the flare will remain in the FOV for a relatively long period of time. At close range, the flare will be in the missile FOV for a relatively short period of time. Several different “response” techniques may be used, either alone or in combinations, to defeat a flare. These “response” techniques include simple memory, seeker push-ahead, seeker push-pull, and sector attenuation.

(a) When the simple memory “response” is initiated, the missile continues the maneuver it was performing just before the “trigger.” This “response” assumes the flare will separate to the rear of the target. The missile rejects the seeker track data and maintains its motion relative to the target, waiting for the flare to leave the seeker FOV. The missile will continue to reject track data until the flare leaves the FOV or until the “trigger” times out. When the “trigger” times out, the “response” is discarded and the seeker operates in the normal track mode. If the “trigger” times out while a flare remains in the FOV, the seeker will usually transfer lock to the flare.

(b) The seeker push-ahead “response” causes the seeker gimbals to drive the seeker forward in the direction the target is moving (Figure 14-17). Pushing the seeker forward causes the flare to depart the FOV faster than with simple memory, minimizing the amount of time the missile is not tracking the target. The greater the amount of forward movement (called “bias”), the faster the flare will depart the FOV. If the amount of forward bias applied is too great, the seeker may be pushed forward of the target. This could cause both the target and the flare to depart the FOV and the missile would have to reacquire the target.

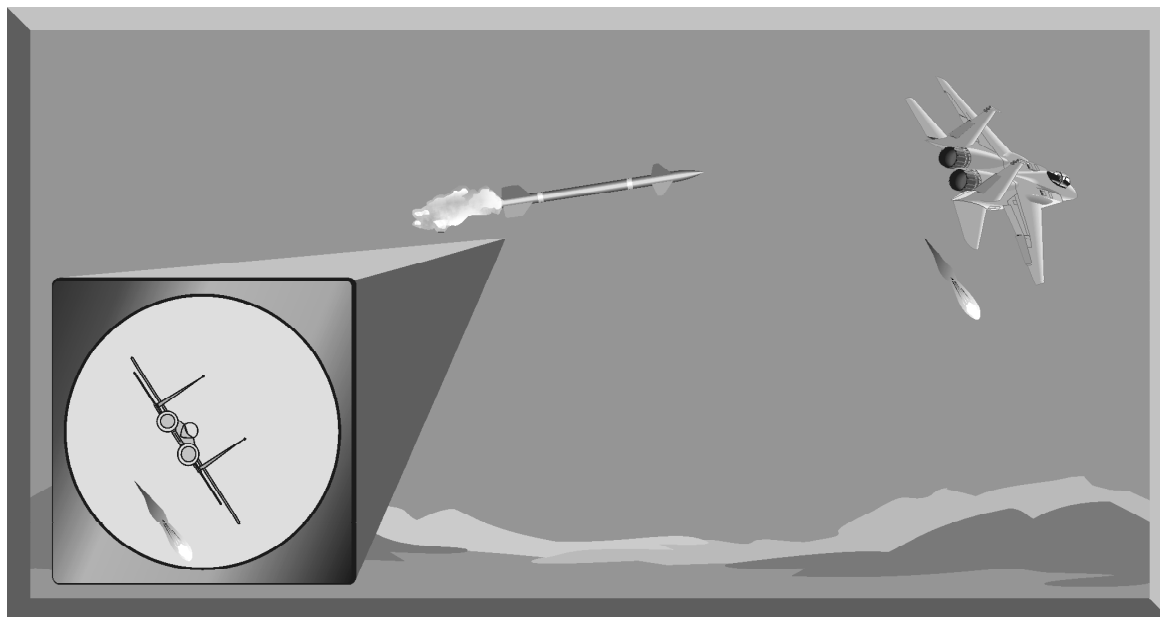

Figure 14-17. Seeker Push-Ahead “Response” Technique

(c) The seeker push-pull “response” assumes flares will have a higher intensity IR signature than the target. The “response” is initiated when the target and flare are on opposite sides of the seeker FOV (Figure 14-18). This corresponds to a spatial “trigger” condition. The received energy will rise and fall as the energy of the target and flare is scanned across the detector. When the flare energy is at a peak, the seeker gimbals drive the seeker away from the flare. When the lesser energy from the target is detected, the seeker's gimbals pull the seeker in the direction of the target. As a result, the seeker is moved away from the flare and toward the coolest IR source in the FOV, the target aircraft.

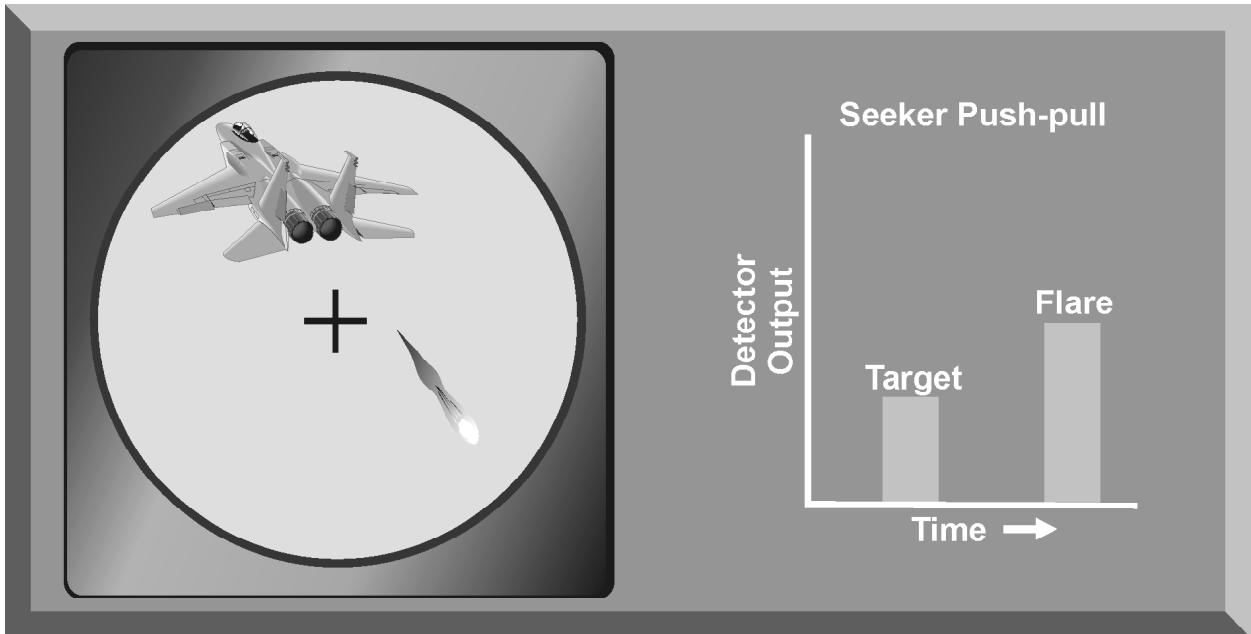

Figure 14-18. Seeker Push-Pull “Response” Technique

(d) The sector attenuation “response” is initiated by placing an attenuation filter across part of the seeker FOV (Figure 14-19). This filter reduces the seeker sensitivity in that part of the FOV. If the target being tracked is in the center of the FOV, then placing an attenuator in the quadrant below and to the rear of the target should reduce any energy received from a flare. If the attenuated flare energy is below that of the target energy, the seeker will continue to track the target.



Figure 14-19. Sector Attenuation “Response” Technique

7. SUMMARY

This chapter provided some background on IR theory and IR detection, then went into some of the basics about the different types of IR missile seekers. Finally factors that impact the ability of an IR missile to reduce the effectiveness of self-protection flares were discussed. This ability depends on the discrimination capabilities of the missile seeker, the type of detector, the missile FOV, and the missile flare rejection capabilities. Modern IR missiles that employ sophisticated flare rejection techniques and advanced missile seeker technologies present a growing, and potentially lethal, threat.

CHAPTER 15. IR COUNTERMEASURES

1. INTRODUCTION

Defeating IR missiles used to be an afterthought placed well behind surviving the radar missile threat. Now with the proliferation of advanced IR missiles, defeating the IR threat is becoming more important and more difficult. The primary countermeasure used to defeat IR missiles is the self-protection flare. This chapter will discuss flare characteristics and employment considerations. One of the main difficulties in defeating an IR missile is knowing that one has been launched. This chapter will also discuss some of the methods currently available to detect an IR missile attack.

2. FLARE CHARACTERISTICS

Self-protection flares were developed to counter threat systems operating in the IR spectrum. Self-protection chaff and flare dispensers, such as the ALE-40, ALE-45, or the ALE-47, are designed to allow the pilot to dispense flare cartridges when engaged by an IR threat. These flare cartridges are pyrotechnic and pyrophoric devices designed to produce an IR source that is more attractive than the IR signature of the aircraft. To decoy an IR missile seeker, the flare must create a heat source more attractive than the aircraft, within the missile field of view. The most important flare characteristics that determine the ability of a flare to decoy an IR missile are IR wavelength matching, flare rise time, and flare burn time. The MJU-7 flare cartridge will be used as an example of a typical flare cartridge.

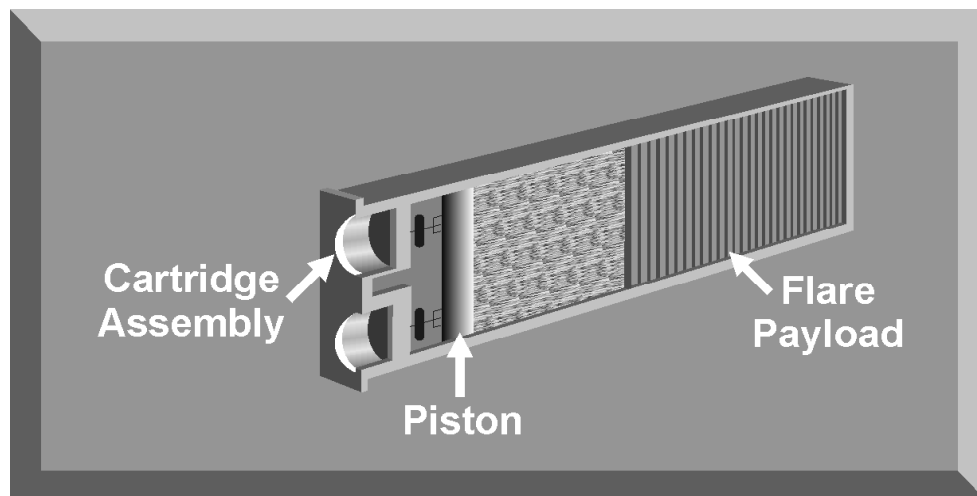

Figure 15-1. The MJU-7 Flare

a. The MJU-7 flare cartridge (Figure 15-1) is an example of a flare cartridge used in both the ALE-40 and the ALE-47 dispensers. The flare grain is composed of magnesium and tetrafluoroethylene, or C_2F_4 , which burns at 2000 to 2200°K. As the flare burns, it emits IR energy of different wavelengths from the luminous zone that emulates the aircraft IR signature. The burning flare also produces a large quantity of white smoke, which may highlight the position of the dispensing aircraft.

b. A flare must reach peak intensity shortly after ejection or it will not be effective in decoying the IR missile seeker. Flare rise time is the time required for the flare to reach peak intensity.

(1) To counter a short-range IR missile with a narrow field of view, a flare must reach peak intensity quickly. On the other hand, some advanced IR missiles now look for a rapid rise in IR energy as a trigger to know when a flare is trying to decoy it (Figure 15-2).

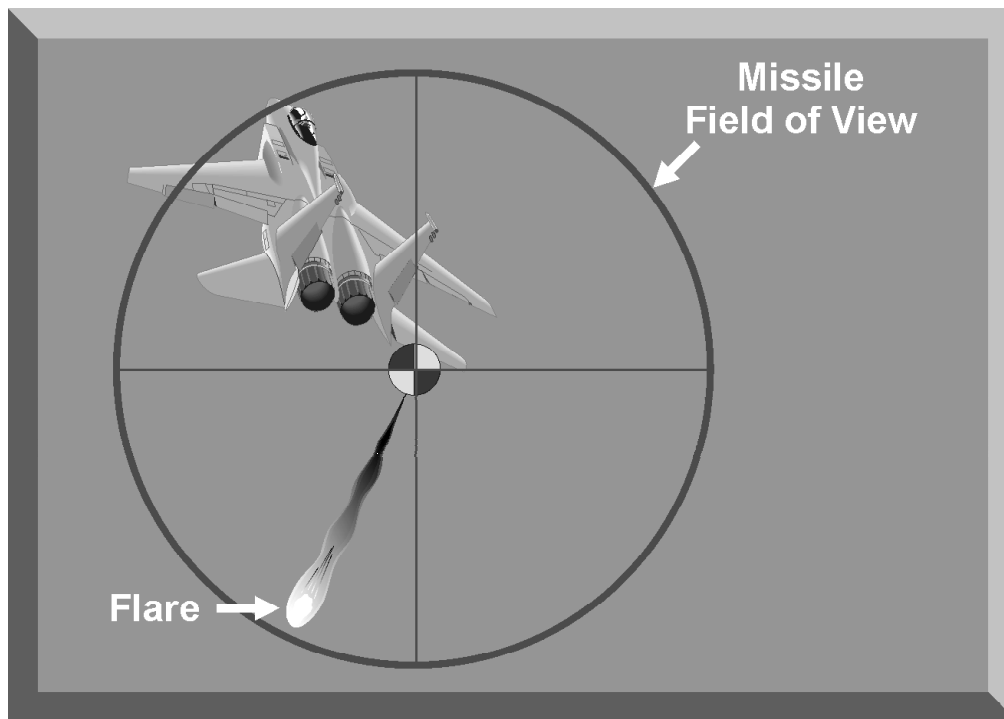

Figure 15-2. Impact of Flare Rise Time

(2) Flare rise time varies dramatically with altitude. The flare burns longer at high altitude, but it takes much longer to reach peak intensity. This increase in flare rise time at high altitude can impact the effectiveness of flares to decoy and defeat IR missiles particularly in the air-to-air combat environment.

c. Flare burn time is the time span that the flare burns and determines how far the IR seeker will be pulled off the target. The longer the burn time, the longer the

IR seeker is pulled off the target aircraft. The flare should burn long enough to ensure that the aircraft is no longer in the missile field of view. Flare burn time, like flare rise time, varies with altitude. A flare will burn longer, but at lower intensity, at higher altitudes. A longer flare burn time increases the probability the IR missile will be decoyed by a single flare.

3. ADVANCED FLARES

To counter the advances in IR missile seeker technology the Air Force and Navy formed the Advanced Strategic and Tactical Expendables program to develop and field advanced IR decoys. Two products to come out of this program are the kinematic flare, MJU-47, and the covert flare, MJU-50/51.

a. **Kinematic Flares.** A significant characteristic of conventional flares is that upon ejection they rapidly slow down and separate from the aircraft. As described in Chapter 14, modern IR missiles exploit this rapid separation between the aircraft and the flare. The rapid separation triggers a flare rejection response in the missile seeker causing it to ignore the flare and continue tracking the aircraft. The kinematic, or thrust, flare delays the missile response by propelling itself in the direction of the aircraft and negating or delaying the missile's flare rejection trigger. The MJU-47 is the same size as the currently fielded MJU-10 flares. The flare's decoying pyrotechnics are vectored out the end of the flare to provide a means of propulsion (Figure 15-3).

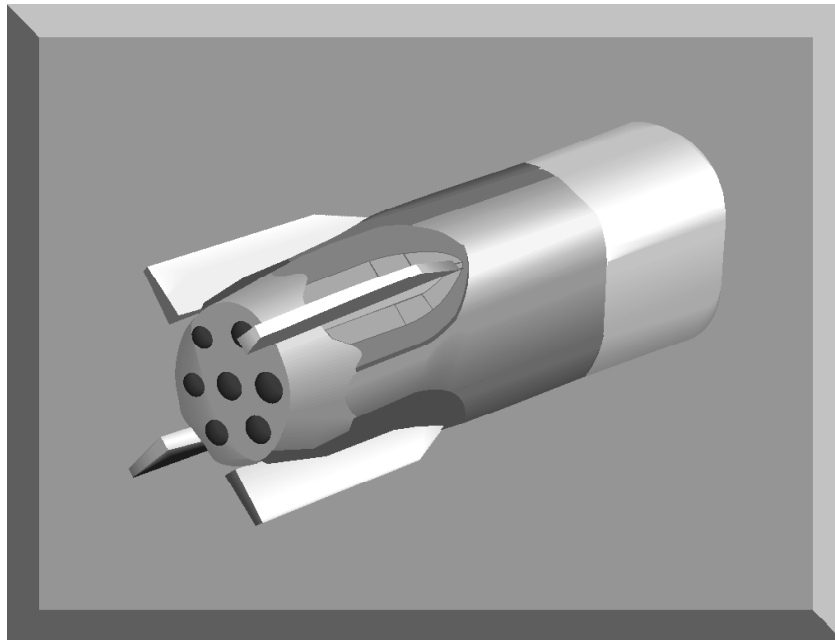

Figure 15-3. Kinematic Flare

b. **Covert Flares.** Though an effective tactic at defeating MANPADS, preemptively dropping flares in a target area carries a significant risk. The risk is that enemy air defense systems that may not have known the aircraft's location will surely see the flares, day or night, and any chance for surprise is lost. Figure 15-4 shows the visual signature of conventional flares. The danger of highlighting oneself becomes even more likely as aircraft become fitted with chaff and flare systems that automatically dispense expendables based upon inputs from the RWR or a missile attack warning system (MAWS). Automatic systems tend to error on the side of caution which means expendables will be dropped if there is any ambiguity. Visually covert flares, named the MJU-50 and MJU-51, remove this problem by not leaving a visual signature such as smoke or flame. These covert flares are made of material that oxidizes, pyrophoric instead of pyrotechnic, when released in the air. The MJU-50 is the size of the small M-206 flare while the MJU-51 is the size of the MJU-7 flare.



Figure 15-4. Flare Visual Signature

4. FLARE EMPLOYMENT

The purpose of employing a self-protection flare cartridge is to decoy the seeker head of an IR missile. This is accomplished by presenting the IR missile with a second heat source with an IR signature that exceeds the aircraft signature. The flare or IR source must appear in the field of view of the IR missile at the same time as the aircraft. As the flare separates from the aircraft, the IR missile seeker tracks the most intense IR signature, which ideally is the flare, and is decoyed away from the aircraft.

a. It is important to perform maneuvers along with flare employment to effectively defeat IR missiles. Maneuvers compound the IR missile's tracking problems and increase the distance between the aircraft and flare. Maneuvers that put the aircraft outside the IR missile field of view increase the ability of the flare to decoy the missile. When engaged by an IR threat, one tactic is to immediately dispense a flare and maneuver to put the missile on the beam. This increases the line-of-sight rate the missile guidance system must process and gives maximum separation between the aircraft and the flare (Figure 15-5).

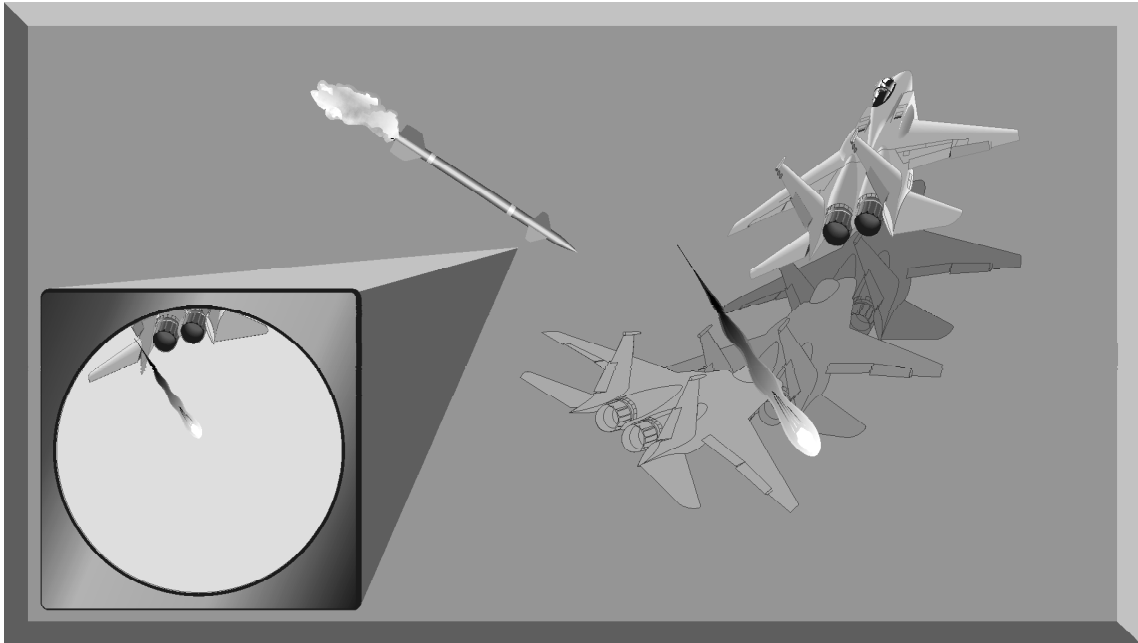

Figure 15-5. Initial Maneuver and Flare Employment

b. With the IR threat on the beam, the pilot has the best chance for achieving a “tally-ho” on the missile to determine range and keep the missile on the beam. Visually acquiring the missile increases the chances of surviving the encounter. Modern chaff and flare dispensers, such as the ALE-47 and ALQ-213, can be programmed to dispense flares in a sequence optimized to defeat specific IR missiles. Programs are selected by the pilot based upon the most likely threat. Classified tactics manuals provide aircraft specific maneuvers and flare dispensing programs to defeat the IR threat.

5. IRCM TACTICS

Besides maneuvers and flare employment, there are other IR countermeasures that can reduce the effectiveness of IR threat systems. The first is to reduce the intensity of the heat signature of the aircraft by reducing the power setting. The engines produce the largest IR signature and are the only source of IR radiation that the pilot can influence. By reducing the power setting, the IR signature is

reduced and the required flare intensity is thereby reduced. Use of afterburner should be minimized for exactly the same reason; the required flare intensity necessary to cover an aircraft in afterburner is difficult to obtain. The pilot should not reduce the power setting below the minimum required to maintain sufficient maneuvering airspeed.

a. Another effective IRCM is to use the sun. Maneuvering into the sun masks the aircraft's IR signature from most IR threat systems. When attacking a target defended by IR systems, an attack axis that places the sun behind the attacker may limit the effectiveness of these systems.

b. Clouds or smoke can also confuse IR threat systems (Figure 15-6). The water vapor making up clouds diffuses the IR energy making it difficult for an IR system to get a point to track, similar to how sun's light is diffused on a cloudy day. The particles found in smoke can have a similar effect on IR energy. The final IRCM is to reduce the IR signature of the aircraft by careful design of the engines and exhaust system. For example, the F-117 was specifically designed to provide the lowest possible IR signature.

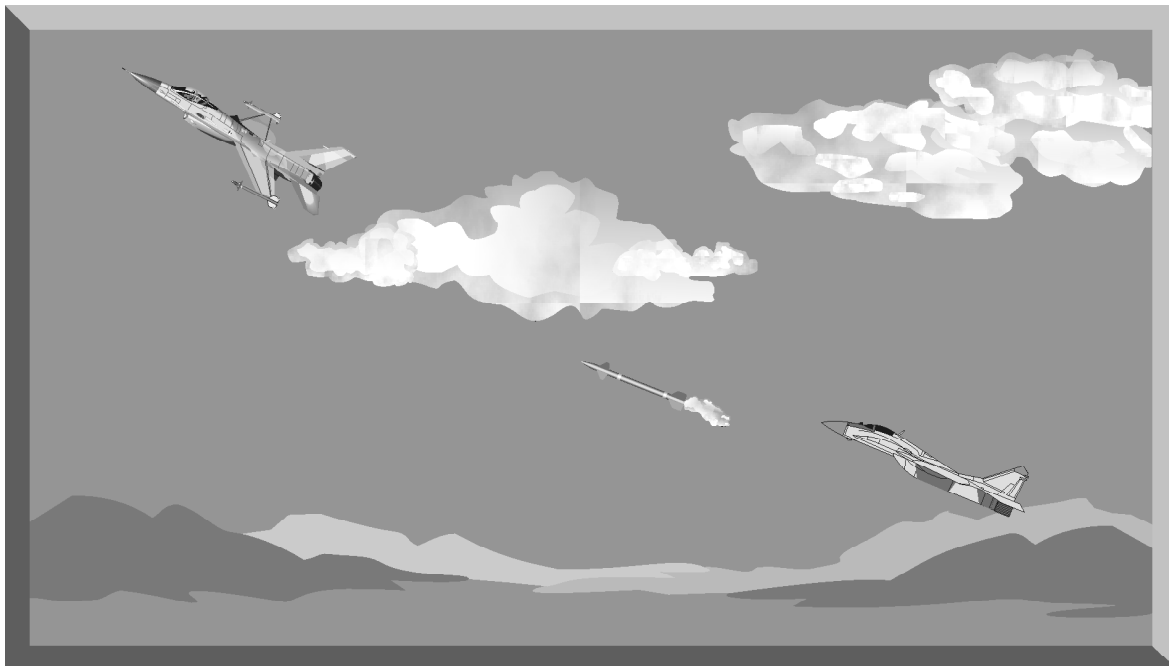

Figure 15-6. IRCM

6. MISSILE APPROACH WARNING SYSTEMS (MAWS)

One of the most important factors in defeating an IR missile attack is knowing that an attack is in progress. Since IR threat systems are generally passive, the radar warning receiver (RWR) will provide no attack warning unless the threat uses some detectable radar energy for acquisition prior to launching an IR

missile. MAWS are designed to provide the crew some warning of an ongoing missile attack. These systems have been widely deployed on larger aircraft. Advances in technology allowing them to be smaller and promising lower false alarm rates have increased the possibility that fighter size aircraft may be outfitted with this equipment.

a. The two primary requirements for MAWS are timeliness and reliability. An IR missile engagement is an extremely short event providing very little time for the targeted aircraft to respond with maneuvers and flares. Secondly, there must be a very low false alarm rate. In earlier systems the sun, flares, or the wingman's aircraft have been known to cause false alarms. Aside from being annoying, a false alarm can become a tactical problem if the MAWS is tied directly into the countermeasures dispenser set allowing for automatic dispensing of chaff and flares when the MAWS senses an attack. False alarms in this type of scenario would only serve to highlight a previously untargeted aircraft.

b. MAWS detect incoming missiles either actively or passively. The active MAWS use a pulse Doppler radar to detect and track the in-flight approach of an attacking missile. Pulse Doppler radar is used for this purpose because of its ability to use relative velocity to pull targets out of clutter. An incoming missile will have a high velocity relative to the surrounding background. Range and time to impact are computed automatically, updated continuously, and provided to the crew to assist in defensive maneuvers (Figure 15-7). The down side to active MAWS is the requirement to continuously radiate for long periods of time to ensure protection. This contradicts the common tactic of keeping radar transmissions to a minimum to avoid being tracked via passive detection measures. This situation has led to the latest generation of MAWS being mostly of the passive type.

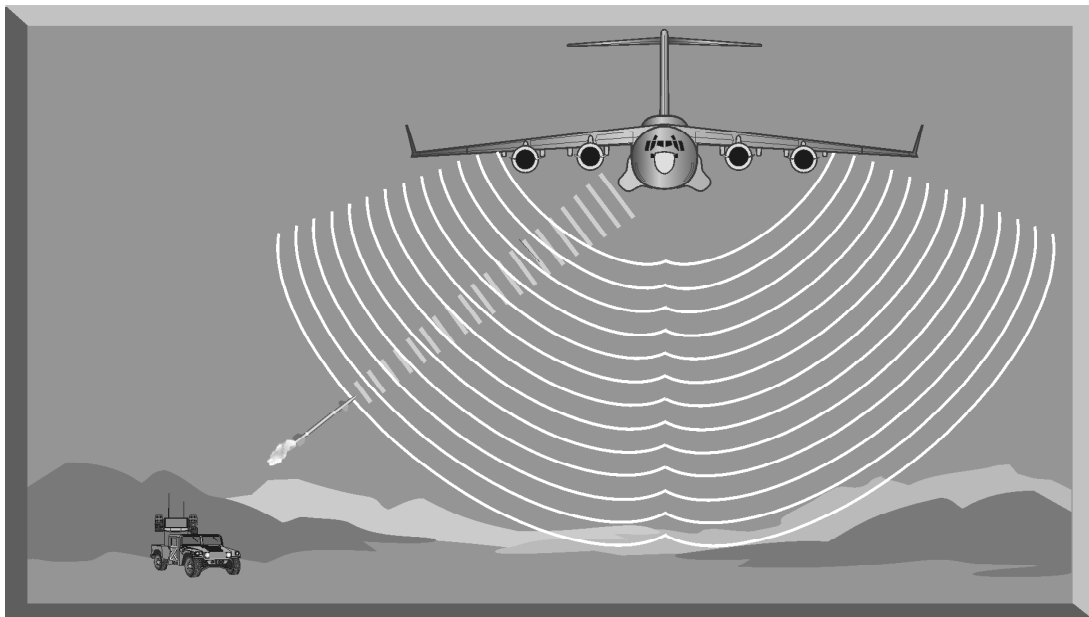

Figure 15-7. Missile Alert Warning System (MAWS)

c. The passive MAWS operate in either the ultraviolet, or the infrared frequency spectrum. These systems are tuned to look for the IR signature of a missile's rocket motor, then pass a warning and the position of the inbound threat to the pilot. To obtain all-aspect missile warning, multiple MAWS sensors must be positioned on the aircraft in a similar fashion to RWR antennas. All-aspect MAWS face the same challenges that RWR systems face: false multiple targets due to maneuvers and accurate threat position reporting, to name a few.

7. SUMMARY

The proliferation of IR threat systems has elevated the importance of IRCM to survival on the modern battlefield. The most effective IRCM is still the employment of flares in conjunction with maneuvers. The specific flare characteristics of IR spectrum coverage, rise time, and burn time are critical factors in determining flare effectiveness. Other IRCM tactics are designed to enhance the effectiveness of flares and take advantage of IR missile limitations. The effectiveness of all IRCM tactics depends on some type of attack warning. The new generation of MAWS should provide some measure of warning to the crews and in some cases automatically defeat the IR missile.

CHAPTER 16. RADAR ELECTRONIC PROTECTION (EP) TECHNIQUES

1. INTRODUCTION

Electronic warfare (EW) is defined as military action involving the use of electromagnetic and directed energy to control the electromagnetic spectrum or to attack the enemy. Nearly every military action, from command and control of an entire integrated air defense system (IADS) to precision guidance of an individual weapon, depends on effective use of the electromagnetic spectrum. Radar systems have become a vital element of nearly every military operation. Since these systems operate across the entire electromagnetic spectrum, much of the EW effort is concerned with countering radar systems. All of the jamming techniques discussed in Chapters 10 and 11 and the chaff employment options discussed in Chapter 13 are specifically designed to counter radar systems. These actions are classified as electronic attack (EA), which is a part of EW.

a. EW is somewhat like a chess game—a series of moves and countermoves within the electromagnetic spectrum. As we develop jamming techniques to counter radar systems, our adversaries develop counter-countermeasures to negate the effectiveness of these techniques. In response, we develop newer techniques and our adversaries respond with new modifications to their radar systems. This series of moves and countermoves can continue for decades. The development and application of radar counter-countermeasures are classified as electronic protection (EP), also a part of EW.

b. The continuing battle to control the electromagnetic spectrum for unrestricted radar employment has resulted in over 150 radar EP techniques. These techniques are designed to negate the effectiveness of electronic jamming and chaff on radar systems. These radar EP techniques can be incorporated into the design of a radar system or added to an existing radar system in response to a jamming technique. It is beyond the scope of this text to discuss all the radar EP techniques in use today. This chapter will discuss the most common EP techniques. They have been organized by function of the technique within the radar. These functions include radar receiver protection, jamming avoidance, jamming signal exploitation, overpowering the jamming signal, pulse duration discrimination, angle discrimination, bandwidth discrimination, Doppler discrimination, and time discrimination.

2. RADAR RECEIVER PROTECTION

The following are some of the most common radar counter-countermeasures designed to prevent receiver overload or saturation.

a. Sensitivity time control (STC) is used to counter close-in chaff or close-in clutter. Receiver gain is set at normal for long ranges and reduced for close-in ranges. One problem with using STC is that close-in targets may be missed if STC is improperly adjusted.

b. Automatic gain control (AGC) is used to counter chaff, clutter, and most types of transmitted jamming. AGC senses the signal level of a receiver's output and develops a back-bias, producing a constant output level. This technique has a slow response time compared to fast AGC and instantaneous AGC, both of which are employed instead of AGC. Also, it cannot maintain correct IF output levels for different intensity signals that are close in range because the bias voltage has a long buildup and decay time.

c. Fast automatic gain control (FAGC) is also employed against chaff, clutter, and most types of transmitted jamming. FAGC works by sensing the signal level of receiver output and develops a back-bias, tending to hold output constant. Response time is within milliseconds, permitting fast response and recovery as the antenna traverses the jammer's bearing. There are several precautions to note when using FAGC. First, targets may be suppressed and lost without the operator knowing that jamming is present. Second, a strong pulse or echo may cause ensuing weak targets to be lost. Lastly, FAGC has difficulty getting an accurate bearing on the jamming source.

d. Instantaneous automatic gain control (IAGC) is another technique to counter chaff, clutter, and most types of transmitted jamming. IAGC senses the signal level of each echo or jamming pulse and develops a back-bias that holds the stage output constant. Gain control response time is within milliseconds and extends the dynamic range of the receiver. There are several precautions to note when using IAGC. First, it is not effective against signals whose "in band" time is less than the IAGC response time. Also, with continuous duty cycle jammers, targets may be lost without the operator knowing that jamming is present. Finally, it is difficult to get an accurate bearing on the jamming source.

e. Automatic noise leveling (ANL) counters noise jamming and modulated or unmodulated constant wave jamming. ANL samples receiver noise content at the end of each PRF and sets the gain accordingly for the next pulse interval. Continuous jamming reduces gain to keep output the same as the original noise level. ANL also follows the scanning rate of the antenna so that receiver noise output is constant as the antenna rotates. When using ANL, targets may be suppressed and lost without the operator knowing that jamming is present. Also, receiver gain is unstable when pulses or swept jamming enter the sampling gate intermittently.

f. The logarithmic receiver (LOG) counters most types of transmitted jamming by amplifying and demodulating large dynamic-range signals in logarithmic amplifiers. This produces "amplitude compression" of the strong

signals. However, when using LOG, output is nearly constant so the operator cannot easily tell when jamming is present.

g. The logarithmic receiver with fast time constant (LOG-FTC) counters narrowband jamming, chaff, and clutter. This technique amplifies and demodulates large dynamic-range signals in logarithmic amplifiers, producing “amplitude compression” of the strong signals. Video is coupled through FTC circuits to eliminate rectified carrier and low frequency sideband products. There are problems with using LOG-FTC. First, the receiver output is nearly constant, so the operator cannot always tell when jamming is present. Second, LOG-FTC is not effective against wideband, or fast-swept, short pulse jamming. Lastly, LOG-FTC causes a broadening of displayed jam sector, as well as degrading bearing accuracy on the jam source.

h. Dicke-fix (DF) counters wideband and fast-swept jamming and is similar in employment to wideband limiting (WBL). DF amplifies without ringing, clips down all pulses to a common level, then amplifies the narrowband echo signal more than the wideband jamming. Noise level is held constant, independent of jamming intensity. There are precautions to note when using DF. Jamming that enters the wideband limiter can capture limiters, causing poor receiver sensitivity. Targets may be suppressed without the operator knowing that jamming is present. Also, resolution and target detection range are reduced, even in a non-jamming environment. Finally, DF is ineffective against extremely fast-swept spot jamming.

i. WBL is used to counter wideband jamming and fast-swept jamming. WBL amplifies without ringing, clips down all pulses to a common level, then amplifies the narrowband echo signal more than the wideband jamming. Noise level is held constant, independent of jamming intensity. However, jamming that enters the wideband limiter can capture limiters and cause poor receiver sensitivity. Resolution and target detection range is reduced, even in a clear environment. Targets may be suppressed without the operator knowing that jamming is present. Finally, WBL is ineffective against fast-swept spot jamming.

j. Adaptive video processing (AVP) counters chaff corridors, weather, sea clutter, and most types of transmitted jamming. AVP combines the adaptive threshold, beam-to-beam correlation, and wide-pulse blanking in frequency-scanning three-dimensional radars to avoid collapsing undesired returns on the PPI display. However, when using AVP, there is a decreased probability of detection in some multiple target situations. Also, targets may be suppressed without the operator knowing that jamming is present. Finally, AVP passes all point targets.

3. JAMMING SIGNAL AVOIDANCE

The following are some EP techniques used to avoid jamming signals.

a. Frequency agility (FA) counters narrowband jamming and some types of repeater and deception jamming. FA enables the radar to make rapid changes of transmitter and receiver operating frequency, sometimes on a pulse-to-pulse basis. Manual frequency changes may cause mutual interference with other radars and services.

b. Frequency diversity works against narrowband jamming and some types of repeaters and transponders. It is a multiple-radar coordination procedure in which radars are assigned operating frequencies that are separated to reduce mutual interference and their susceptibility to a single jammer. It is important to note that other radars may be operating at the same allocated operating frequency.

c. Polarization diversity is used to counter chaff, weather, and transmitted jamming. Polarization diversity attenuates jamming input to a radar receiver by using antenna polarization different from jammer polarization, and usually involves separate radars of different polarization. There are two precautions when using polarization diversity: (1) ground clutter worsens on vertical polarization, and (2) close coordination is necessary if separate radars are used; for example, one horizontally polarized search radar and one vertically polarized search radar.

d. Circular polarization (CP) works against chaff, weather, and transmitted jamming. CP attenuates jamming input to a radar receiver by using antenna polarization different from jammer polarization, and usually involves separate radars of different polarization. CP also improves target detection in rain clutter.

e. Conical-scan-on-receive-only (COSRO) is employed against inverse conical scan jamming to deny a jammer the ability to sense and upset scan angle tracking information. A constantly transmitted illumination beam is received and scanned to derive target angle information. However, the jammer can still degrade angle tracking if it can approximate the received signal scan rate.

f. Speedgate tracking is used against all types of transmitted jamming. The technique provides a very narrow bandpass having a center frequency related to Doppler shift. Only jamming within the restricted band is effective. It has the advantages of accurate target Doppler discrimination and good target tracking at low target levels. However, the speedgate can be stolen by gate stealers and some types of swept jamming.

g. Leading-edge track (LET) is used to counter an incoming target dropping chaff by allowing target tracking on the leading edge of the target. Trailing edge track (TET) is used to counter a receding target dropping chaff.

h. Track coast is used to counter chaff, clutter, multiple targets, range gate stealers, jam fades, and blinking jamming by placing tracking radar in a rate-aided coast condition. The system “estimates” target position to avoid interrupting the fire control solution. A lock-on or return to acquisition mode terminates the track coast condition. Track coast requires adequate storage of rate-aided information, and no true tracking information will be developed while track coast is operating.

i. Guard gates work against chaff, clutter, multiple targets, range gate stealers, jam fades, and blinking jamming. Guard gates provide automatic detection of a foreign signal and “estimates” target position to avoid interrupting fire control solutions. Like track coast, guard gates require an adequate store of rate-aided information with no true tracking information developed.

4. JAMMING SIGNAL EXPLOITATION

The following are some EP techniques that use the jamming signal for target acquisition and engagement.

a. Passive angle tracking (PAT) counters most types of transmitted jamming by allowing the radar to acquire and angle-track the source of jamming signals. There are some problems with this technique. Blinking jamming can cause severe instability, and the range of the jammer is unavailable until the target reaches burnthrough range.

b. Home-on-jamming (HOJ) counters most types of transmitted jamming by allowing the missile or radar to use the jamming signals, locate the source, and home on it. However, blinking jamming can cause severe instability, and the range of the jammer is unavailable until burnthrough.

c. Jamming signals produce recognizable sounds that help in their detection and identification. Aural recognition allows an operator to listen to the Doppler frequency associated with a moving target. It is used to counter most types of jamming.

d. The local oscillator off technique counters continuously transmitted jamming. No receiver output occurs unless a target echo signal and a jamming signal are present. Limitations of this technique include: targets only display in an area where jamming is present; and, if the antenna rotates away from the jammer, or if jamming is turned off, no targets are displayed on the radar scope.

e. The jamming strobe indicator counters any transmitted jamming with high-duty-cycle modulation. The indicator is a variable marker strobe on the radar display that moves in range proportional to jamming strength. The indicator traces an antenna lobe pattern on the display, showing the azimuth of the jamming source. There are some problems with the jamming strobe indicator. First, it interrupts normal video in some radars. Second, inverse or sidelobe

jamming can cause erroneous strobes. Finally, the jam strobe does not react to unmodulated CW or low-duty-cycle jamming for some radar systems.

f. The jamming indicator lamp, located on the operator console, is used on radars with automatic noise leveling (ANL) to counter continuous transmitted jamming. The lamp alerts the operator to the presence of jamming, and the ANL is manually shut off. This action allows the operator to determine jammer bearing.

g. Clean strobe generation (CSG) counters any transmitted jamming by using the sidelobe blanking circuits of a radar. An azimuth strobe appears when the jamming level in the main antenna exceeds the jamming level in the sidelobe auxiliary antennas. The operator is alerted to the presence and bearing of a jamming source, even with a constant false alarm radar (CFAR) receiver.

h. Jamming attenuation (JAM ATTEN) counters both clutter and any type of jamming. Receiver gain is reduced to avoid receiver saturation by inserting an attenuator pad that enables the operator to recognize presence, type, and bearing of a jamming source. When using JAM ATTEN, however, the reduced gain may cause loss of targets, even in non-jammed sectors. Also, any improvement in signal-to-jam ratio is not possible.

i. Receiver manual IF gain (MAN GAIN or IF GAIN) also counters clutter and jamming. Receiver gain is reduced to avoid jamming saturation by manually reducing stage gain, allowing the operator to identify jammer presence, type, and bearing. When using IF GAIN, the reduced gain may cause a loss of targets, even in non-jammed sectors. Also, any improvement in signal-to-jam ratio is not possible.

5. OVERPOWERING THE JAMMING SIGNAL

Following are some EP techniques a radar system can employ to overpower jamming and reduce the jamming-to-signal (J/S) ratio to less than one.

a. Burnthrough counters most types of transmitted jamming. Energy in the target pulse is raised by increasing the peak power, that is, the PRF or pulse width, or by increasing the time the radar illuminates the target by reducing the scan rate or scan angle. Some radars have modes in which the radar concentrates its power in narrow azimuth and elevation sectors about the suspected target position. However, burnthrough can degrade general radar performance by overloading the receiver if a large radar cross section target is detected. High power may impact radar operation in clutter or dense chaff environments.

b. Narrowband long pulse (NBLP or NLP) counters most types of transmitted jamming by using a high-energy long pulse. The signal uses a narrowband receiver for reception, and increases detection range for targets in jamming and

in the clear. Simultaneously, it reduces resolution, which causes poor radar performance in chaff and clutter.

6. PULSE DURATION DISCRIMINATION

The following are some radar counter-countermeasures that use pulse duration to discriminate between radar and jamming signals.

a. The fast time constant (FTC) is used to counter chaff, clutter, and narrowband jamming. A video circuit provides low frequency attenuation to reject carrier and low frequency modulation jamming. FTC passes normal radar pulse lengths with little attenuation, but causes some loss of receiver sensitivity.

b. Pulse width discrimination (PWD), clutter eliminate (CE), and wide pulse blanking (WPB) are designed to counter chaff, most types of jamming, EMI, and some types of deception jammers. A video coincidence gate, involving a delay line matched to the expected signal duration, senses if a return is the proper pulse width. PWD, CE, and WPB provide an enabling path for qualified signals. However, weak signals may be lost in the signal processing.

c. Pulse expansion-compression (PC) is used to counter most types of noise jamming and some types of deception jamming. An expanded pulse is coded for transmission. This expanded pulse is transmitted and decoded on return. Echo responses are then compressed in a decoding process. This expansion/compression is equivalent to NLP, which provides longer detection ranges, and wideband short pulse, which provides increased resolution. Using PC is not without problems. Unwanted residues may cause loss of weak targets. Additionally, range error proportional to the Doppler shift, or radial velocity, affects the accuracy of the PC.

7. ANGLE DISCRIMINATION

The following techniques use angle discrimination to distinguish between radar returns and jamming signals.

a. Sidelobe blanking (SLB) and sidelobe cancellation (SLC) are types of sidelobe suppression (SLS) used to counter sidelobe response to chaff, clutter, transmitted jamming, sidelobe jamming, and deception jamming. An auxiliary antenna approximates the pattern and gain of sidelobes of the main antenna and produces a signal for comparison with the signal received in the main antenna. If the signal in the auxiliary antenna is greater, the signal in the main antenna channel is blanked. This permits bearings to be obtained on a jamming source and rejects sidelobe jamming. SLB is useful only for determining the bearing to the jamming source.

b. Antenna manual positioning, antenna traverse and elevation angle offset, antenna jog, and antenna slow scan are EP techniques used to counter main

beam and sidelobe jamming and deception. These techniques are designed to increase the antenna scans across the jammed sector to increase the blip-scan ratio. These techniques increase the number of pulses integrated, as well as the operators' sorting capability.

8. BANDWIDTH DISCRIMINATION

The following are EP techniques that use bandwidth to distinguish between radar jamming and target returns.

a. Dicke-fix (DF) counters wideband and fast-swept jamming. A wideband limiter amplifies without ringing and clips all pulses down to a common level. Then an amplifier increases narrowband target echo signals more than the wideband jamming. There are some problems associated with DF. Any jamming entering the wideband limiter can “capture” the limiters and cause poor receiver sensitivity. Targets may be suppressed without the operator knowing that jamming is present. Resolution and target range is reduced, even in a clear environment. Finally, DF is ineffective, even harmful, when the jamming bandwidth is near the bandwidth of the desired echo signal.

b. Transmitter pulse lengthening (TPL) counters wideband and fast-swept jamming. TPL concentrates power into a narrow band about the carrier frequency by lengthening the transmitting pulse. While this allows use of a narrowband receiver, it impairs resolution, causing poor chaff and clutter performance.

c. Transmitter pulse shaping (TPS) counters wideband and fast-swept jamming. The sideband range is limited by shaping the transmitted pulse. This allows use of a narrowband receiver, but impairs resolution, causing poor performance in chaff and clutter.

d. Narrowband pulse limiting (NBLP or NLP) is a form of transmitter pulse lengthening that counters wideband jamming and fast-swept jamming. NBLP concentrates power into a narrow band in the carrier frequency by lengthening the transmitting pulse. This allows use of a narrowband receiver, but impairs resolution, causing poor chaff and clutter performance.

e. The fast time constant (FTC) is used to counter chaff, clutter, and narrowband jamming. A video circuit provides low frequency attenuation to reject carrier and low frequency modulation of jamming. FTC passes normal radar pulse lengths with little attenuation, but causes some loss of receiver sensitivity.

f. High video pass (HVP) is used to counter chaff, clutter, and narrowband jamming. It is similar to FTC. A video circuit provides low frequency attenuation to reject carrier and low frequency modulation jamming. HVP passes only the leading edge of the received pulses. HVP can cause some loss of receiver sensitivity.

g. The wideband short pulse (WSP) counters chaff, clutter, and narrowband jamming by transmitting a short pulse and using a wideband receiver for reception. Echo resolution and accuracy are improved, and performance against narrowband jamming is enhanced. However, the maximum detection range is decreased and system vulnerability to wideband jamming is increased.

h. Narrowband limiting (NBL) counters chaff, clutter and narrowband jamming. A narrowband filter positioned in the front of the amplifier section allows only the target signal bandwidth to enter the limiter, reducing wideband and off-frequency jamming. The limiter clips all signals and noise to a common level. This technique is useful only when followed by pulse compression or other “decode” techniques. NBL is not effective against wideband jammers capable of causing “ringing” of the NBL bandpass filters. Targets may be suppressed and lost without the operator knowing that jamming is present. Finally, target detection and resolution are poor.

9. DOPPLER DISCRIMINATION

EP techniques that use Doppler frequency discrimination between radar and jamming signals to negate jamming effectiveness include the following:

a. Moving target indication (MTI) is used to counter chaff and clutter. The phase of returned target echoes is compared on a pulse-to-pulse basis. Those with no phase change (no change in radial velocity) are cancelled using a delay-line canceler. Sensitivity using MTI is poor for weak targets, even in the clear. Also, it is blind to targets that have a Doppler frequency that is equal to a multiple of the radar PRF, unless PRF stagger is used. Finally, limited dynamic range does not allow full cancellation of strong clutter echoes.

b. Compensated coherent MTI, also known as compensated COHO MTI, counters chaff and clutter by comparing the phase of returned target echoes on a pulse-to-pulse basis. Those pulses with no phase change, that is, no change in radial velocity, are cancelled. Corrections to the coherent oscillator are applied to compensate for motion of the platform and radar antenna. Sensitivity is poor for weak targets, even in the clear, and it is blind to targets that have a Doppler frequency equal to, or a multiple of, the radar PRF, unless PRF stagger is used.

10. TIME DISCRIMINATION

The following EP techniques use time discrimination between radar and jamming signals to negate jamming effectiveness.

a. Video integration (VINT) and integrate-multiply (INT-MULT) counter any form of transmitted jamming not synchronous with radar PRF. The video continuously circulates through a delay line, delaying signals exactly one pulse recurrence time (PRT), then combines them with signals from the next PRT. Synchronous target signals add together to increase video output, but noise and

random pulses are suppressed. Unless MTI and FTC are employed, VINT and INT-MULT will enhance chaff, clutter, and jamming along with target returns. Also, feedback control, or loop gain, must be carefully adjusted for optimum results.

b. PRF stagger and jitter are EP techniques designed to counter quasi-synchronous jamming, EMI, MTI blind-speeds, “second trip” echoes, and repeater jammers simulating “closer-than-real” targets. The transmitter pulse interval is varied to break up synchronous patterns. Received signals must be “de-staggered” for use with MTI or integration. When using any of these techniques, video de-stagger balance must be accurate or “double video” occurs. These techniques are not effective against exact synchronous deception jamming.

c. Pulse-to-pulse correlation (PPC) is used to counter slow-swept blinking or pulsed jamming not synchronized with radar PRF, and some types of deception jammers. To be displayed, target video must exceed a threshold voltage for two successive pulses. The technique avoids displaying non-synchronous jamming and EMI, but is not effective against synchronous jamming, and may cause weak targets to be missed.

d. Beam-to-beam correlation (BBC) is used to counter slow-swept blinking or pulse jamming not synchronous with radar PRF and some types of repeaters and transponders. It is used in three-dimensional frequency scanning or frequency agile radars. To be displayed, the target return echo signal must exceed a threshold value in two adjacent antenna beams. BBC is not effective against synchronous jamming. It may also cause weak targets to be missed.

e. Single beam blanking (SBB) is used to counter slow-swept, blinking, pulsed jamming, and narrowband jamming. It is used in three-dimensional frequency scanning or frequency agile radars to avoid displaying vertical beams containing jamming. A blanking pulse is generated for vertical beams containing jamming so that they are not displayed. The technique is not used on RHI video. Also, it can cause a loss of targets at the jammed elevation angle on the PPI display.

11. SUMMARY

This chapter has discussed some of the most widely employed EP techniques designed to counter radar jamming. The capabilities of the individual radar operator were not discussed. However, the radar operator is as important as the EP techniques designed for the radar system. Many of the most effective EP techniques are designed to ease operator interpretation of the radar display. In the chess game of EW, the capabilities of individual radar operators can be as important as the sophisticated EP techniques in determining the final outcome.

CHAPTER 17. RADAR WARNING RECEIVER (RWR) BASIC OPERATIONS AND GEOLOCATION TECHNIQUES

1. INTRODUCTION

Radar surveillance and radar-directed weapons represent the biggest threat to aircraft survival on the modern battlefield. The first step in countering these threat systems is to provide the pilot or crew with timely information on the signal environment. The radar warning receiver (RWR) is designed to provide this vital information to the pilot. The RWR system is an example of an electronic warfare support (ES) system. The primary purpose of an RWR system is to provide a depiction of the electronic order of battle (EOB) that can have an immediate impact on aircraft survival. Though the RWR system is complex, the basic operations of the various components are straightforward. A step above RWR systems is threat geolocation. While an RWR provides the EOB for a single aircraft, threat geolocation systems can provide accurate threat location data for numerous aircraft over an entire region. Threat location data is used for aircraft threat avoidance and, more common today, the preemptive attacking of enemy radar sites. This chapter will discuss the functions of the various components of a RWR system including the antennas, receiver/amplifiers, signal processor, emitter identification (EID) tables, RWR scope, RWR audio, and limitations to RWR systems. This chapter will then go on to discuss three of the methods used to geolocate radar threat systems.

2. RWR ANTENNAS

Antennas are designed to receive radar pulses from threat radar systems. Factors that impact the operation of the RWR antennas include location, pattern, sensitivity, and polarization.

a. The physical location of the RWR antennas on the aircraft can affect its ability to detect a radar signal. Antennas are arranged to cover a predetermined area of horizontal and vertical space around the aircraft (Figure 17-1).

b. The antennas and their patterns play an essential part in displaying the spatial relationship of a threat radar to the aircraft. The antenna patterns are the areas, or “footprints,” that the antennas are specifically designed to cover. These footprints are directly affected by the relative position of the antennas to the threat systems. This is because the signal processor measures and compares signal strength from all the aircraft antennas to compute threat signal location relative to the aircraft. This relative location is then presented on the RWR scope display. Aircraft movement and maneuvering shifts these relative positions during flight and can distort the true threat position on the RWR scope. Precise position determination is not possible with most RWRs.

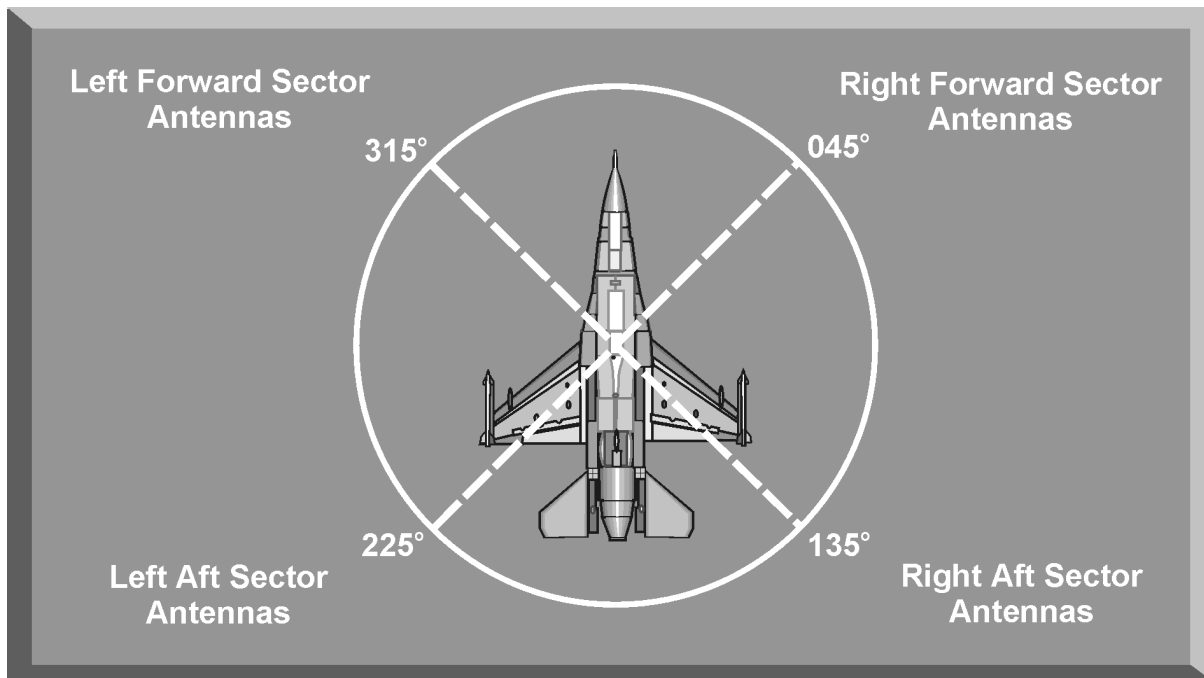

Figure 17-1. Radar Warning Receiver (RWR) Antennas

c. The sensitivity of an RWR antenna directly affects its ability to detect a radar signal. The more sensitive the antenna, the further it can detect a signal. The sensitivity of a system and its ability to intercept a radar signal is usually expressed in decibels relative to milliwatts or dBm units. A 10 dBm change in sensitivity can result in a 25 nm range difference in target detection. In general, sensitivity levels of -50 to -60 dBms are required to detect signals at long ranges (Figure 17-2).

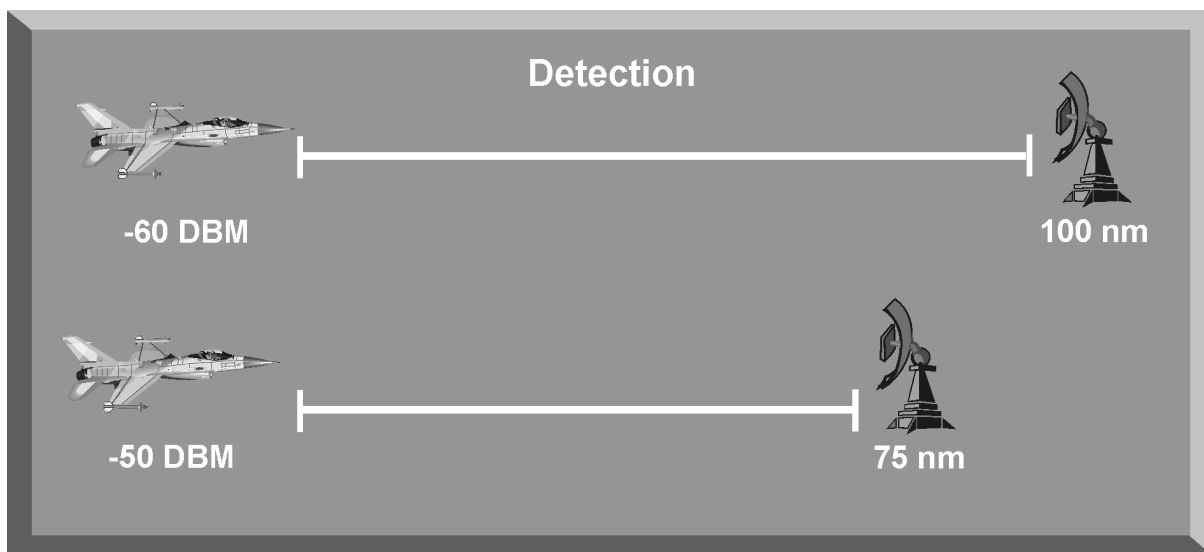

Figure 17-2. RWR Antenna Sensitivity

d. Another factor affecting antenna detection range is the polarization of the antennas. If the polarization of the RWR antenna and the threat system antenna are mismatched, or cross-polarized, initial detection of a threat signal could be delayed until the aircraft is within the lethal range of a threat system. In this situation, the aircraft could be engaged with minimal warning (Figure 17-3).

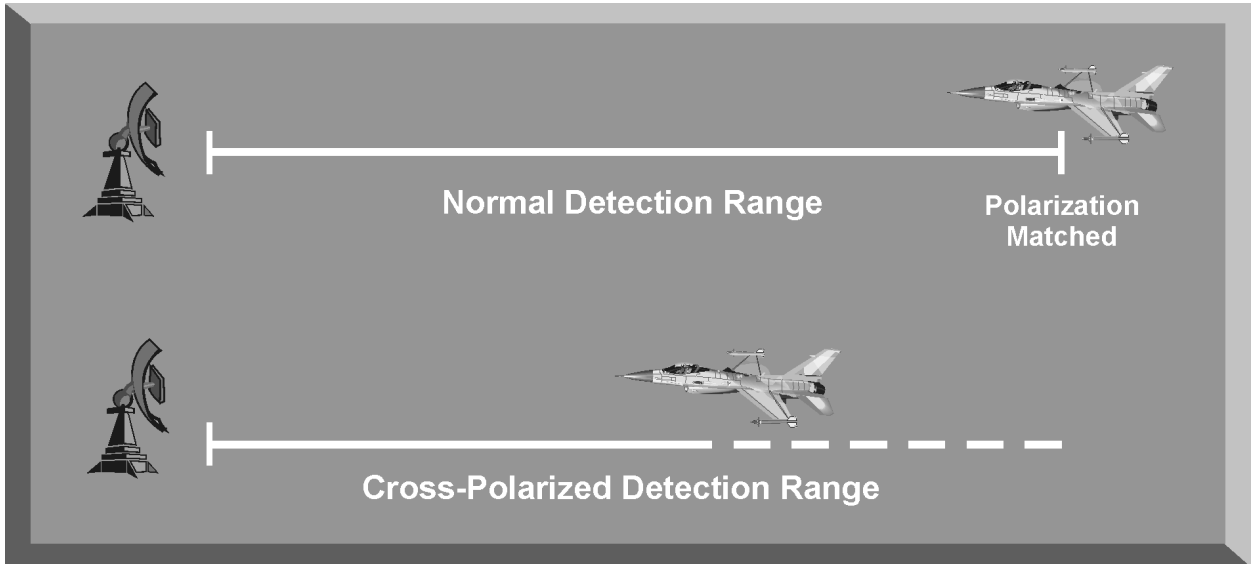

Figure 17-3. RWR Antenna Polarization

3. RWR RECEIVER/AMPLIFIERS

The RWR receiver/amplifier section processes the radar signals from the antennas. Most RWR systems use frequency bands to differentiate signals. Nominal band designations are summarized in Table 17-1. There are two types of receivers currently used in RWR systems: the crystal video receiver and the superheterodyne receiver.

Table 17-1. RWR Frequency Band Designators

RWR Frequency Band	EW Frequency Band
Band 0	Charlie-Delta Bands
Band 1	Echo-Foxtrot Bands
Band 2	Golf-Hotel Bands
Band 3	India-Juliet Bands

a. A crystal video receiver (CVR) is the simplest type of microwave receiver. It is used primarily for detection of pulse radar signals in the 2 to 18 GHz band. A CVR used in a radar warning receiver incorporates crystal detectors for each designated frequency band. A pulse radar signal is detected by the antenna and passed to the multiplexer. The multiplexer divides the received radar signals by frequency band and sends the signals to the appropriate band channel. The RF amplifier boosts the radar signal and passes it to the crystal detector (Figure 17-4).

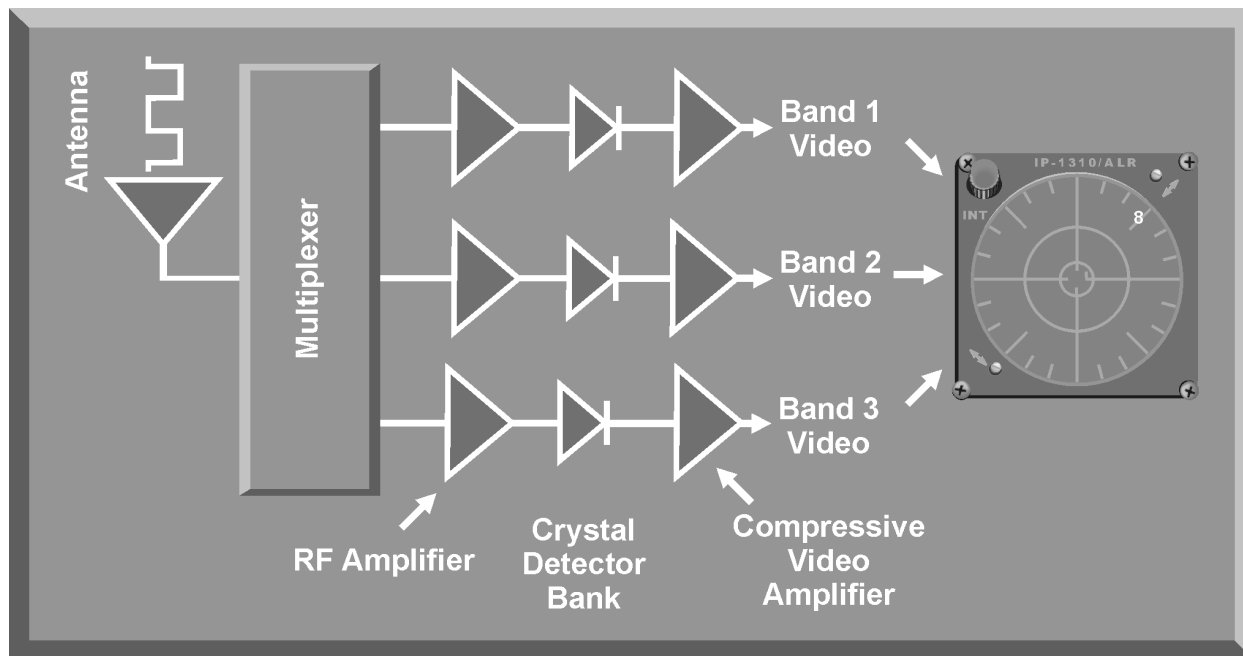

Figure 17-4. Crystal Video RWR Receiver

(1) The crystal detector is an RF diode, which converts the RF signal into a video signal. The voltage level of the output video signal is dependent only on the amplitude of the input signal and not on the frequency or phase. The sensitivity of a CVR is limited by the sensitivity of these crystal detectors. The sensitivity of crystal detectors currently available is generally adequate to detect main beam radiation from most threat radars. The video output of the crystal detectors is amplified by a high-grain compressive video amplifier and sent to the RWR scope for display.

(2) A CVR is extremely fast, sensitive, and covers a wide frequency range. These characteristics coupled with low cost and small size make CVRs ideal for use in radar warning receivers. The primary disadvantage of a CVR is that it is indiscriminate in reception and can be saturated in a dense signal environment. Multiple signals in the same band can cause amplitude distortion which can mask key threat signals.

b. A superheterodyne RWR receiver uses a pre-selector filter, mixer, and a local oscillator to translate the received signal to a lower intermediate frequency (IF). This lower IF allows the receiver to amplify and filter the received signal to provide greater sensitivity and frequency selectivity than a CVR (Figure 17-5).

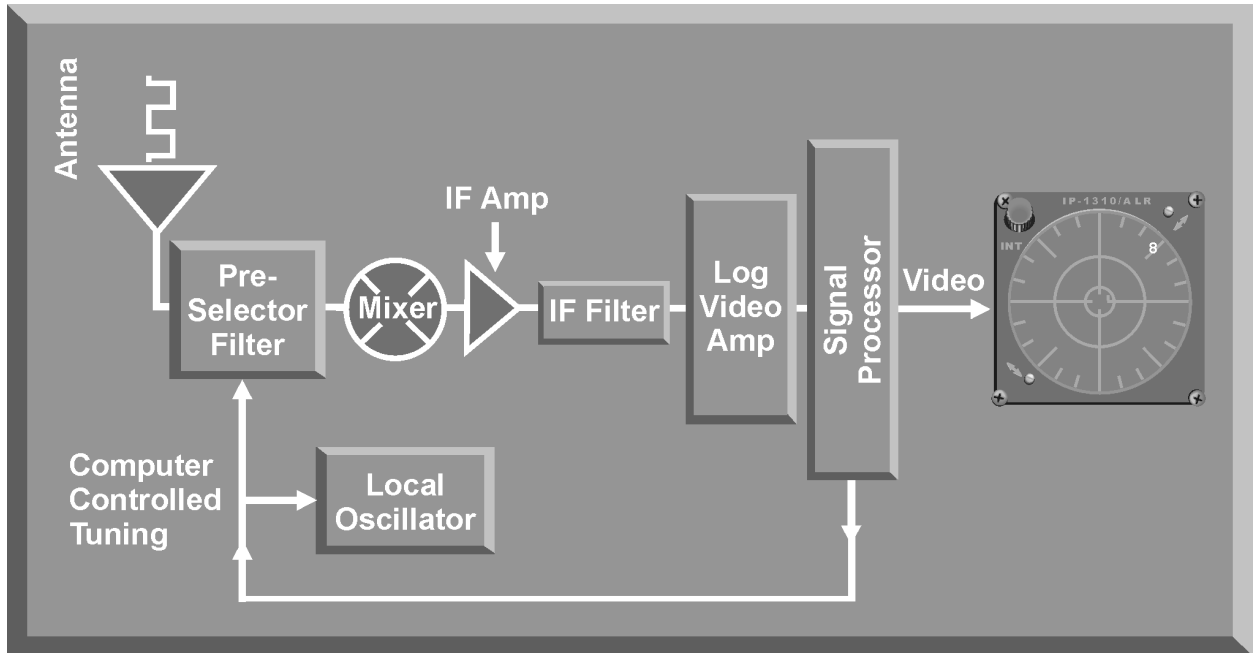

Figure 17-5. Superheterodyne RWR Receiver

(1) Superheterodyne RWR receivers use special scanning techniques controlled by the signal processor to tune the pre-selector filter and the local oscillator to rapidly scan selected threat system frequency bands. If the receiver detects activity in any of these bands, the scan stops to allow the processor to analyze the detected signals. The signal is combined with the local oscillator signal to lower the frequency to the IF. This signal is amplified, filtered, and amplified again before it reaches the signal processor. The signal processor classifies the threat and displays the proper threat symbol to the pilot. This entire process is accomplished in a matter of microseconds.

(2) The scanning superheterodyne receiver has important features that make it effective for RWR system application. It has excellent sensitivity and selectivity. It also has good frequency resolution. These features give the superheterodyne receiver a very low false alarm rate. The major disadvantage of the scanning superheterodyne receiver is its limited capability to receive signals from threat systems employing scanning antenna patterns. This limitation can be overcome with specific computer-controlled tuning to look for these threat signals.

4. SIGNAL PROCESSOR

The signal processor is the heart of the radar warning receiver. The signal processor is also known as the digital processor or analysis processor in different RWR systems. Its primary functions are to process numerous complex radar signals and identify, among the thousands of similar signals, those generated by lethal threat systems. The signal processor accomplishes this task continuously over the duration of the mission and displays the identified threat system to the aircrew almost instantly.

a. Signal processing begins when RF energy strikes the receive antennas on the aircraft. The received signals are then boosted in strength by intermediate amplifiers or antenna receivers. These amplified signals are then sent to the signal processor, or digital processor, where they are assigned a track file for reference to other signal characteristics. Data in these files is compared to those in the emitter identification (EID) table to process the signal for identification. Once identification is complete, a video and, if necessary, an audio signal, is sent to the cockpit display. The audio and video signals alert the aircrew to the electronic environment around the aircraft. This whole process takes less than a microsecond (Figure 17-6).

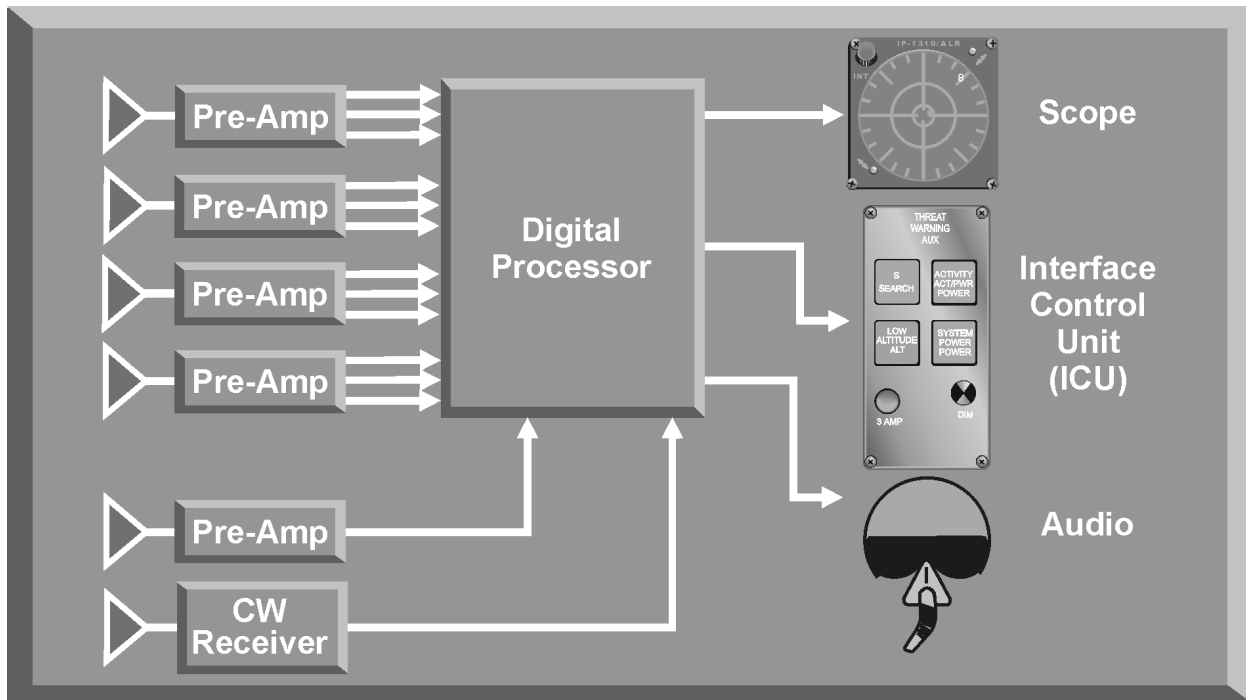

Figure 17-6. RWR System

b. Since many signals may be present, the amplifier detectors boost the signal strength, and also tag each signal by certain characteristics such as its time of arrival, direction of arrival, and/or frequency. These signals, along with their respective tags, are sent to the signal processor for further processing and

identification. The signal processor then makes a track file for each signal it receives from the amplifier detector.

c. The signal processor classifies each received signal and corresponding track file by its unique radar signal characteristics. Identifying characteristics used by a signal processor can include radio frequency, pulse width, pulse repetition frequency, EP techniques, and more. Characteristics of one signal may be identical to characteristics from different signals, while certain other characteristics can be as unique as a human fingerprint. The signal processor uses these primary characteristics to identify specific signals. When the primary characteristics of two or more signals are similar, the signal processor uses additional signal characteristics to resolve any confusion between two or more signals.

d. The signal processor ranks the track files based on priorities determined from tests it conducts on the signal characteristics and the threat priorities contained in the EID tables. It then quickly processes signals belonging to lethal threats before it processes signals belonging to non-lethal threats. For example, three signals enter the processor together and separate track files are established for each signal (Figure 17-7). A test on the first characteristic discriminant, frequency, will delay the further processing of Signal 3, since no lethal threat systems operate at a frequency less than 2000 megahertz. A further test on the remaining prioritized signals may eliminate Signal 2 as a threat system signal, leaving more processor time for the identification of the threat system which generated Signal 1. These tests do not stop the processor from attempting to identify all received signals. The signal processor merely delays the identifying sequence until all high priority signals have been processed.

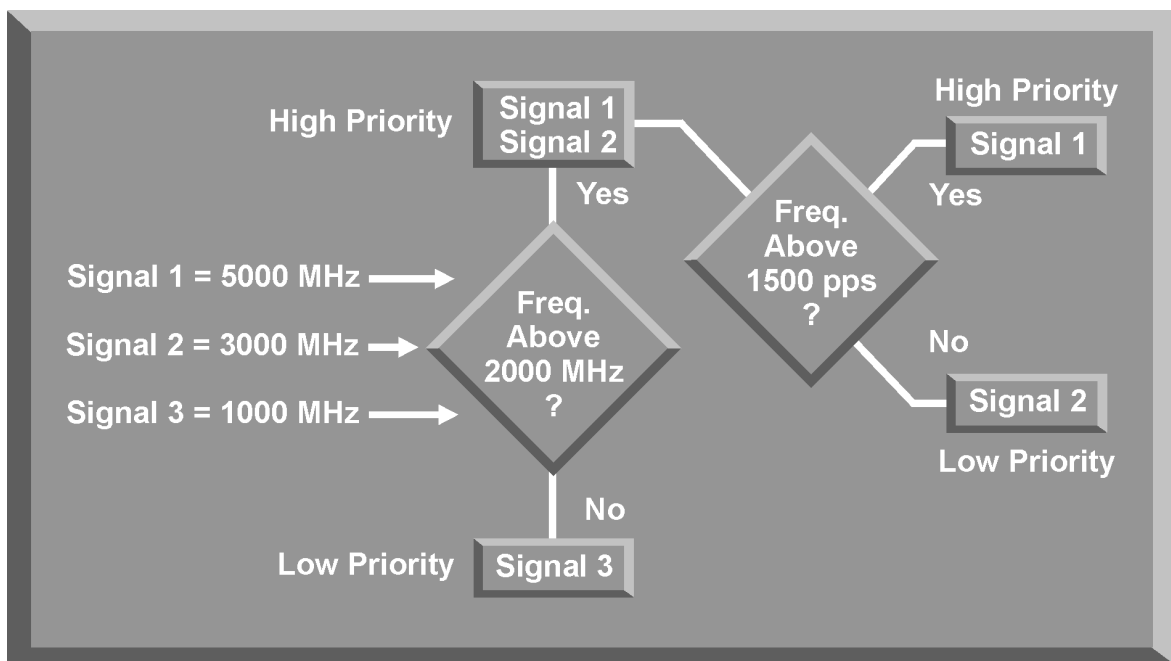

Figure 17-7. Signal Processor Signal Priority

5. EMITTER IDENTIFICATION (EID) TABLES

The signal characteristics in each track file are filled with processed data, and are constantly updated based on the time of arrival and location of the received signals. In addition, the track files are constantly compared to the EID table installed in the signal processor's computer memory. The EID table is a predefined table of radar characteristics associated with known radar systems (Figure 17-8). It is created from information gathered from electronic warfare support (ES) assets and intelligence sources. This table can be changed and updated as necessary to reflect the most current radar characteristics available for the anticipated threats in the planned theater of conflict. Each RWR system has unique procedures to reprogram the signal processor and update the EID tables. Emergency reprogramming actions, such as would be taken if a new threat appears that is not part of the current EID, are called a Pacer Ware.

Frequency	PRF	Scan Rate	PW	Power
5000 MHz	2000 pps	16.0 Hz	0.5 ms	1500 kw
Modulation	BW	PRI	Polarization	Beams
TWS	7.5°	--	--	--
Missile Guidance	Frequency Agility	EP	EP	EP
--	--	--	--	--

Figure 17-8. Sample EID Table

6. RWR SCOPE DISPLAY

The signal processor continually compares signal characteristics in the track files with the data in the EID tables. Once the signal processor has determined that enough of the signal characteristics match the information in the EID tables, it generates and positions a video symbol on the RWR scope. The video symbol represents a specific threat, and each threat system has its own unique symbol. In addition, an audio tone is generated to alert the pilot. The signal processor also generates symbols and audio associated with specific threat system actions, including search, track, and missile launch. The position of the threat symbol on the RWR scope always represents the relative position of the threat in relation to the aircraft which is the center of the RWR scope. The signal processor compares the received signal strength in the different antennas to determine the proper location of the threat symbol. Figure 17-9 depicts a situation where the two

forward antennas receive equal signal strength therefore the signal processor places the symbol at the 12 o'clock position.

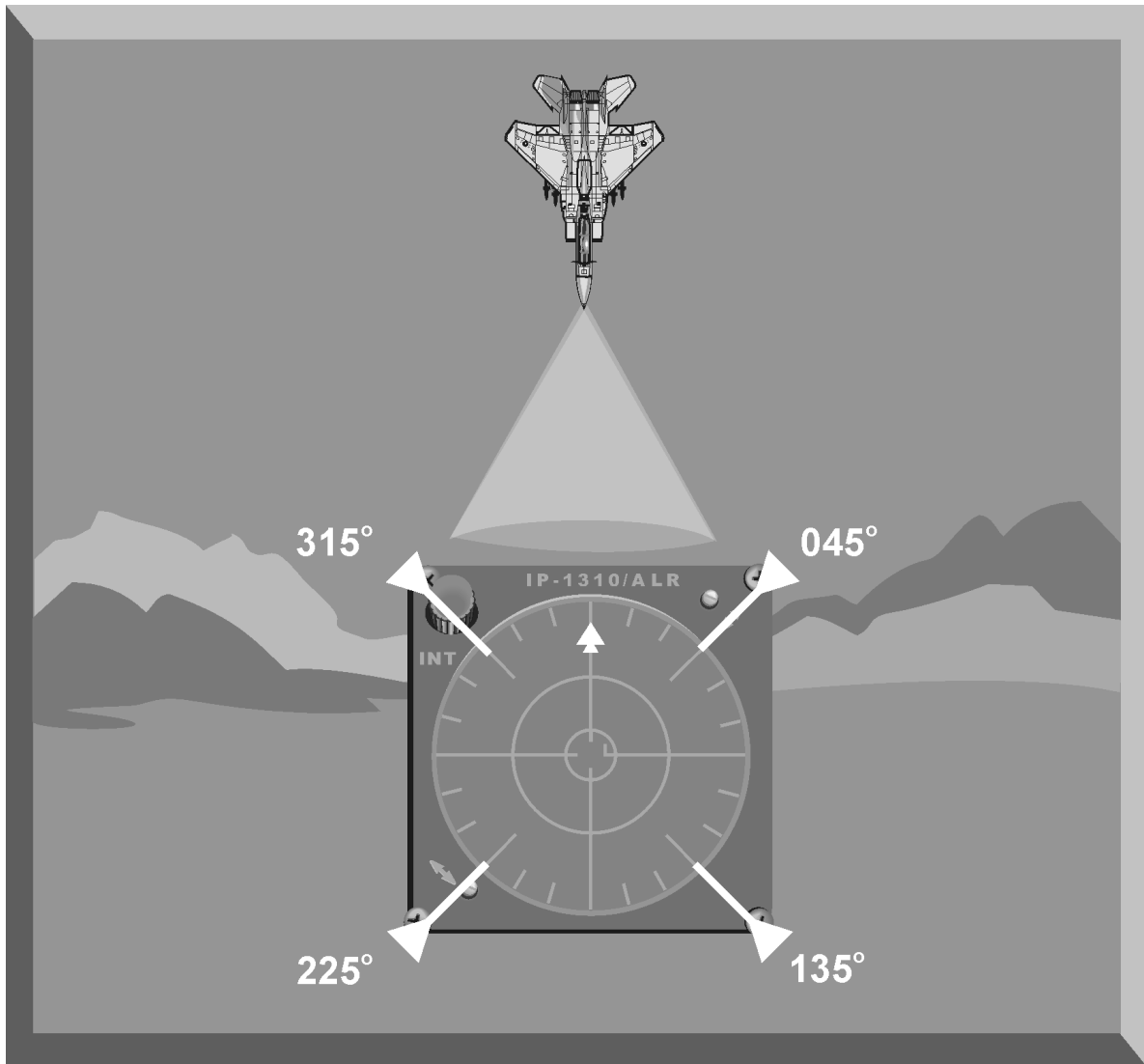

Figure 17-9. RWR Scope Azimuth Positioning

7. RWR AUDIO

In addition to generating threat symbols for each identified threat, the signal processor also generates threat audio. Threat audio first alerts the aircrew to the detection of a threat system. This RWR audio is generally referred to as “new guy” alert audio. The signal processor can also present constant audio from a selected threat. The aircrew controls this function through the interface control unit. The constant audio provided by an RWR system can be either “real” or synthetic. “Real” audio is normally based on the actual pulse repetition frequency (PRF) of the threat system radar whether the signal processor has identified it or not. Synthetic audio is based on the classification of the threat (SAM, AI, etc.) as

determined by the signal processor. The signal processor also generates a launch warning audio when the signal characteristics of the threat indicate a missile launch condition exists.

8. RWR INTERFACE CONTROL UNIT (ICU)

Every RWR system has some type of an ICU which provides the aircrew interface with the signal processor (Figure 17-10). The buttons on the ICU control specific functions of the signal processor. The ICU allows the aircrew to optimize the RWR system based on mission tactics. This optimization includes selecting appropriate priority lists based on ingress and egress tactics, controlling threat audio presentation, and determining the number and types of threats displayed. In addition, the ICU provides an additional visual indication of missile launch. All system test functions are controlled by the ICU to allow the aircrew to monitor the status of the RWR system.



Figure 17-10. RWR Interface Control Unit

9. RWR LIMITATIONS

There are several limitations associated with all RWR systems. The most important limitations include ambiguities, impact of maneuvering, and electromagnetic interference (EMI).

a. The sheer number and diversity of radar systems associated with an enemy IADS greatly compound the problem of threat identification and warning for RWRs. Adding to this problem is the fact that many different threat systems use operating modes that are parametrically similar. When an RWR processes a

radar signal that has the same characteristics of a signal from a different system, an ambiguity may occur. An RWR ambiguity is defined as the display of more than one symbol for a specific threat signal. RWR ambiguities may occur from both enemy and friendly radar systems.

(1) Figure 17-11 depicts a number of friendly and threat signals that operate between 8000 and 10,000 megahertz. On any given combat mission, it is quite possible that the RWR will receive signals from one or more of these threat systems at the same time. If frequency is the only signal characteristic available for processing, the RWR will not be able to determine which system the signal represents. Since threat systems operating in this frequency range are potentially lethal systems, the signal processor will attempt to match the frequency with a threat system from the EID table.

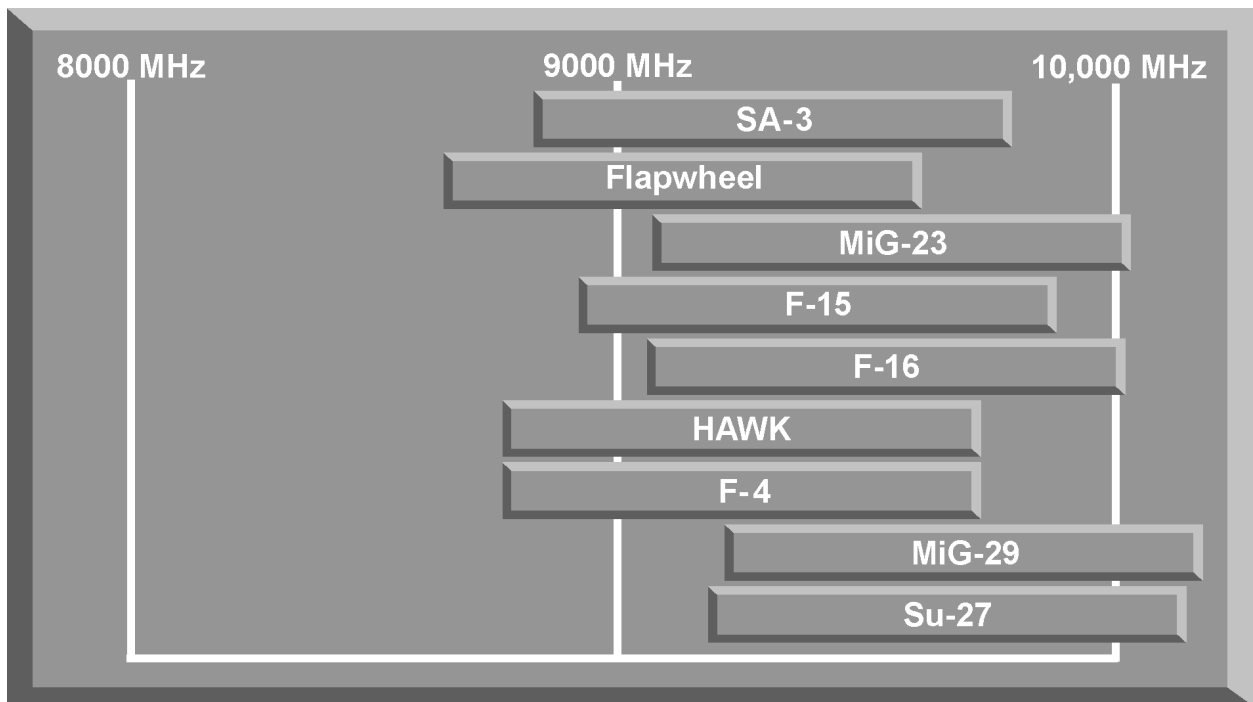

Figure 17-11. Signal Frequency Spectrum

(2) Matching partially processed signals to threat systems in the EID table may result in the wrong threat symbol being displayed, or numerous symbols being displayed on top of each other, making it difficult for the pilot to distinguish the exact threat. Incorrect threat symbology, or numerous combined symbols, are called RWR ambiguities.

b. RWRs are designed to provide accurate threat positioning information when the aircraft is flying straight and level. Most RWRs will also provide accurate threat positioning information when the aircraft is maneuvering up to certain limits of bank angle and turn rate. If aircraft maneuvering exceeds these

limits, RWR threat positioning data becomes unreliable. The two RWR limitations associated with aggressive maneuvering are inaccurate threat azimuth and multiple threat symbols.

(1) In Figure 17-12, the right forward and right aft RWR antennas detect a threat signal from a TTR. The left forward and left aft antennas are shielded by the aircraft and do not detect the signal. The signal processor determines the threat position, using the azimuth positioning algorithm, and displays the threat symbol at the 2 o'clock position.

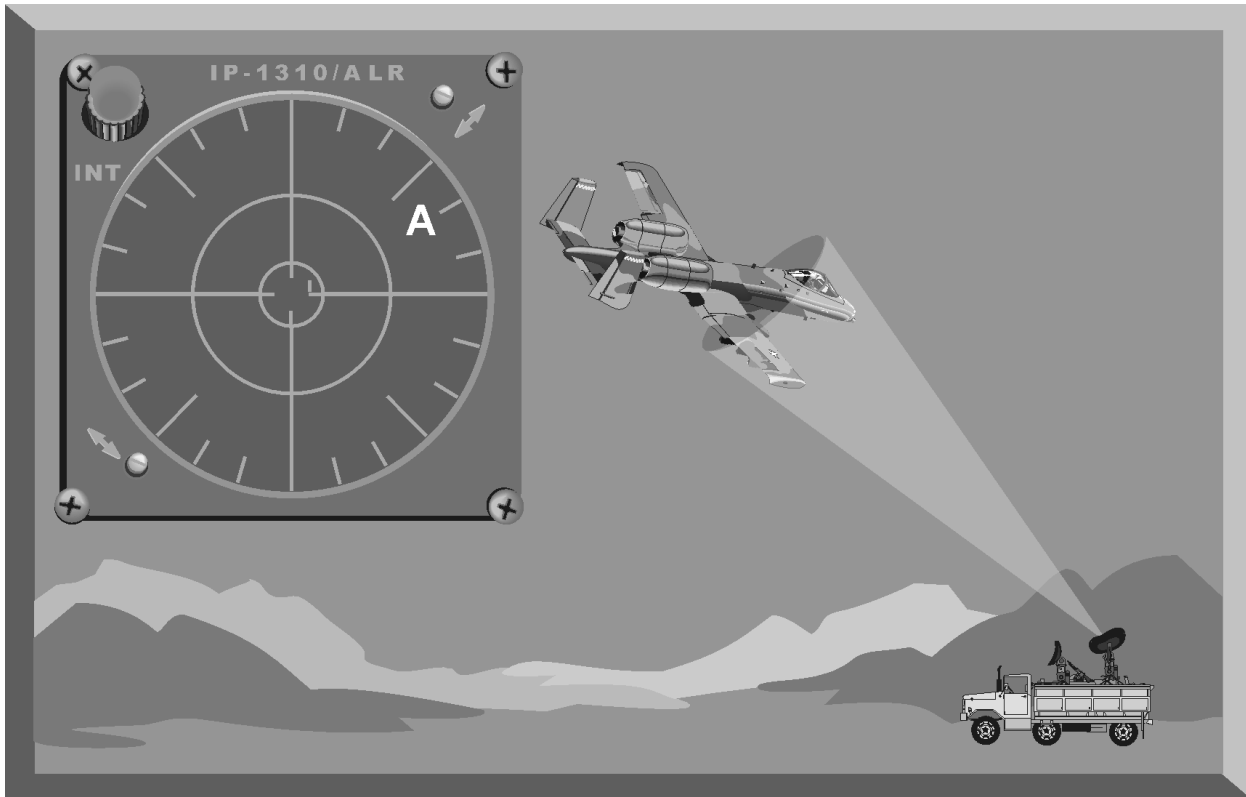

Figure 17-12. RWR Threat Azimuth Position Determination

(2) When the pilot maneuvers aggressively to put the threat symbol on the beam, he exceeds the RWR maneuvering limitations (Figure 17-13). Now all four RWR antennas detect the TTR signal. The signal strength in the right and left forward antennas is nearly equal. Based on this information, the signal processor displays the RWR symbol at the one o'clock position while the threat is actually at the three o'clock position.

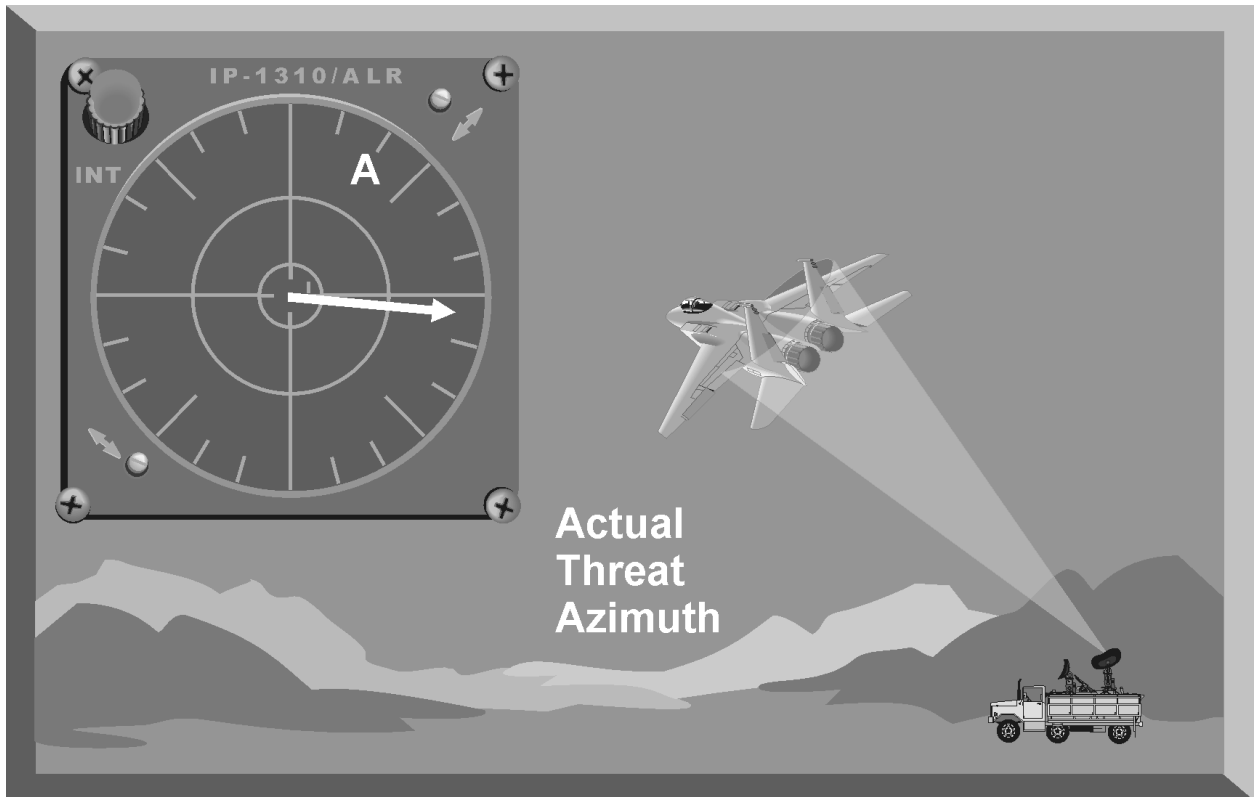

Figure 17-13. RWR Azimuth Error

(3) During aggressive maneuvering, the RWR signal processor may generate multiple symbols for a single threat emitter. In Figure 17-14, as the aircraft maneuvers, the relative azimuth of the threat position changes rapidly causing signal strength detected by each antenna to also change rapidly. The signal processor interprets these changing signals as new and different threat systems with the same signal characteristics. The number of “false” threat symbols displayed for a single threat is determined by the processing speed of the signal processor and a parameter called the symbol “age-out” time. Symbol age-out is the time, normally in seconds, that the RWR will continue to display a threat symbol after the signal processor has determined that the threat is no longer transmitting. The symbol age-out time is set for each threat in the EID tables.

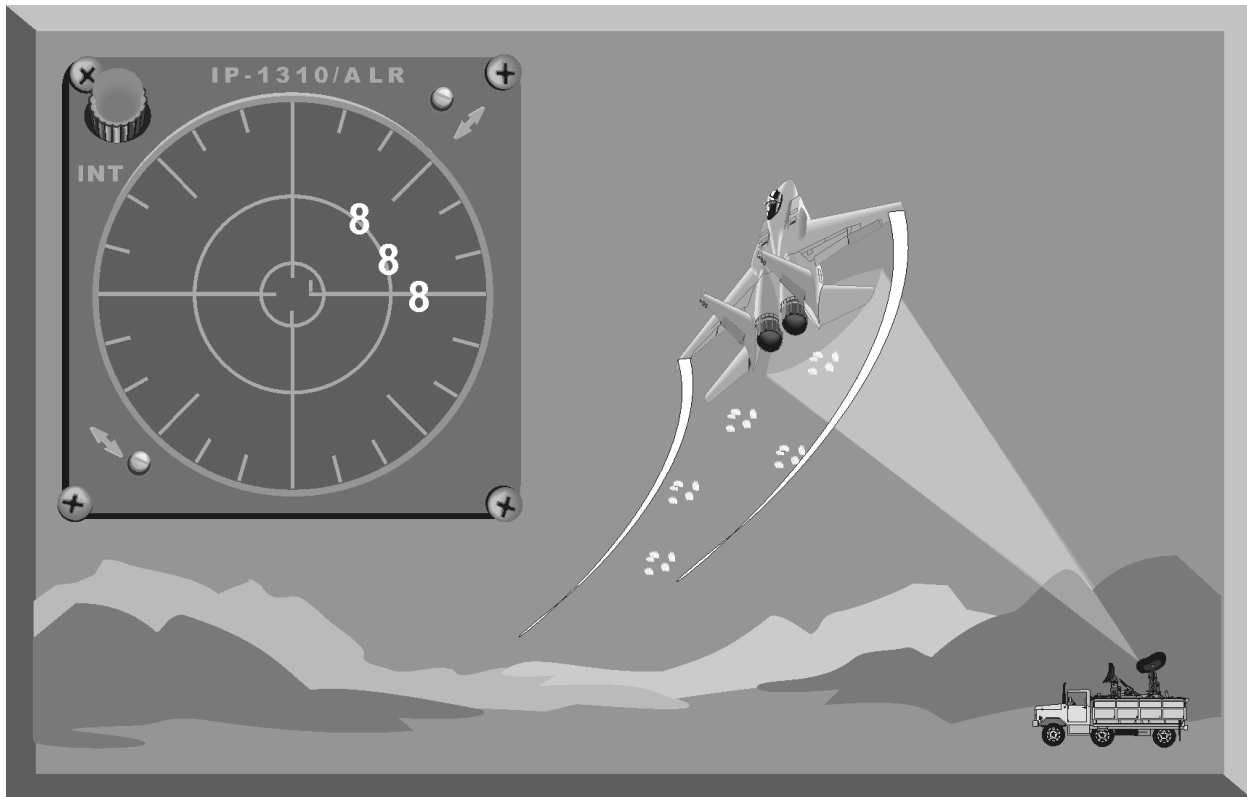

Figure 17-14. RWR Multiple Threat Symbols

c. Electromagnetic interference (EMI) is defined as any electromagnetic disturbance that interrupts, obstructs, or otherwise degrades or limits the effective performance of electronic systems. EMI can be induced intentionally, by way of jamming, or unintentionally as a result of spurious emissions and modulations. Certain RWR characteristics make them susceptible to EMI. Modern RWR systems are designed to receive and process signals in a wide frequency range, nominally 0.5 to 18 GHz, where most threats operate. This broad frequency coverage combined with the sensitive antennas make RWR systems susceptible to EMI. The primary source of EMI that impacts RWR operation is noise and deception jamming designed to counter enemy threat systems.

(1) High power noise jamming, such as that provided by a stand-off jamming aircraft, causes the RWR to raise the receiver threshold in the frequency band of the jamming. This effectively reduces the sensitivity of the RWR receiver and could delay the display of threat signals in that band. The reduction in sensitivity depends on the power that the jammer is transmitting, the beamwidth of the jamming beam, and the distance from the jammer to the aircraft. High power jamming may also generate multiple threat symbols on the RWR scope at the approximate azimuth to the jammer's position relative to the aircraft. Additionally, jamming from a wingman's self-protection system can generate multiple threat symbols and reduced sensitivity.

(2) A limitation of all RWR systems, related to EMI, is the problem of inaccurately identifying threat radar systems as friendly radar systems. This occurs when the parameters of a friendly radar are similar to the parameters of a threat radar system. The RWR will either display a threat radar symbol or an ambiguity associated with a threat radar. These RWR misidentifications are especially prevalent for AI radar systems.

(3) The impact of EMI on the operation of an RWR system depends on the signal environment. The pilot has little control over the number and diversity of friendly and enemy signals the RWR system must process. EMI is an unfortunate consequence of the reliance of modern military forces on operations in the electromagnetic spectrum. Aircrews should be keenly aware that EMI will impact RWR operation and must be familiar with common RWR displays of EMI.

10. THREAT GEOLOCATION TECHNIQUES

The purpose of threat geolocation is to put a defined position, normally coordinates, on a threat radar. This information can be used to simply warn other aircraft about the threat or, if the coordinates are accurate enough, to allow for targeting and attack of the threat. Until recently, threat geolocation could only be performed by strategic assets and specialized tactical aircraft, specifically the F-4G Wild Weasel. Due to inherent time delays, data provided through strategic channels often did not apply to mobile threat systems. The mobile systems would relocate making the data obsolete. This section will discuss three techniques used to geolocate, also known as direction finding (DF), emitting radars that can be used by tactical assets to rapidly locate radar threat systems. The three are triangulation, interferometry, and time of arrival. All three techniques are heavily dependent upon the receiving aircraft's ability to accurately determine its present position, and the advent of GPS receivers has made this significantly easier.

a. Triangulation is the most basic form of DF available. It involves taking direction measurements from more than one source. The intersection of the azimuth measurements, called "lines of bearing", is the likely location of the emitter (Figure 17-15). To be effective, the participating aircraft must have accurate data of their current positions when getting the lines of bearing.

(1) Triangulation can be carried out by multiple aircraft equipped with receiver equipment or by one aircraft over a period of time. The advantage of having multiple aircraft providing azimuth measurements is the increased angle-off and the speed of interception. In triangulation the best azimuth cuts are those that approach 90° angles. The speed of interception comes into play because threat emitters, knowing that DF operations are underway, attempt to transmit for as little time as possible. The disadvantage of multiple platforms is the communication required to ensure that all the platforms are measuring the same radar. In a dense radar environment this can be a difficult task.

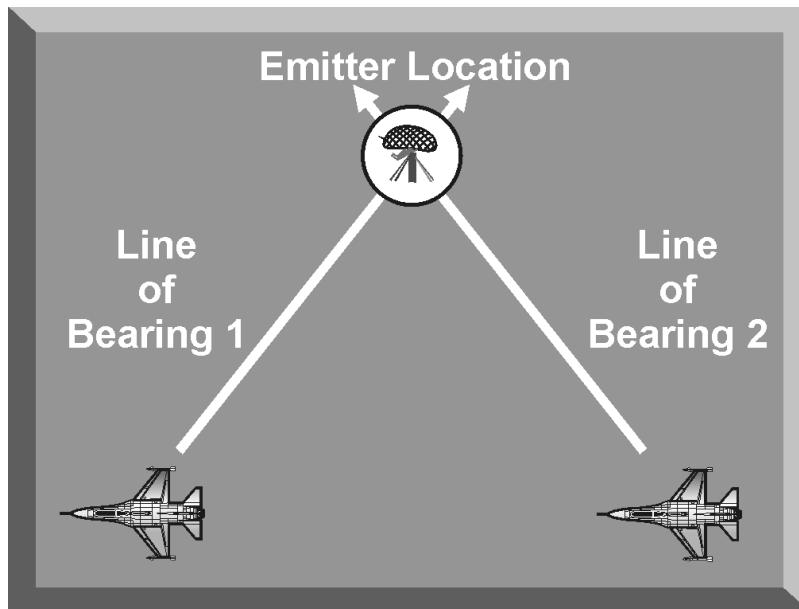

Figure 17-15. Triangulation

(2) Single aircraft triangulation eliminates the problem of signal coordination with other aircraft, but it also requires that the aircraft transit some distance to get multiple azimuth measurements. The accuracy of single ship DF operations is a function of the quality of the receiver equipment, distance away from the targeted radar, speed of the aircraft, and the amount of time that the targeted radar radiates.

b. The second technique is called interferometry. This technique is also known as phase interferometry, or phase difference of arrival. These systems operate by comparing the phase of a radar wave as it impacts two or more DF antennas; this phase difference is then used to compute an angle of arrival (AOA). For aircraft, the desire is to have these DF antennas on different parts of the same aircraft. Multiple AOA measurements are then used to provide the range and position of the threat.

(1) The key elements in an interferometer system are two antennas in fixed locations with matched receivers, a phase comparator, and a processor (Figure 17-16). An intermediate frequency output from each receiver is passed to a phase comparator, which measures the relative phase of the two signals. This relative phase position is passed to a processor, which calculates the AOA relative to the orientation of the two antennas (called the baseline). In most systems, the processor also accepts information about the orientation of the baseline (relative to true North or local horizontal) to determine the true azimuth or elevation angle to the emitter.

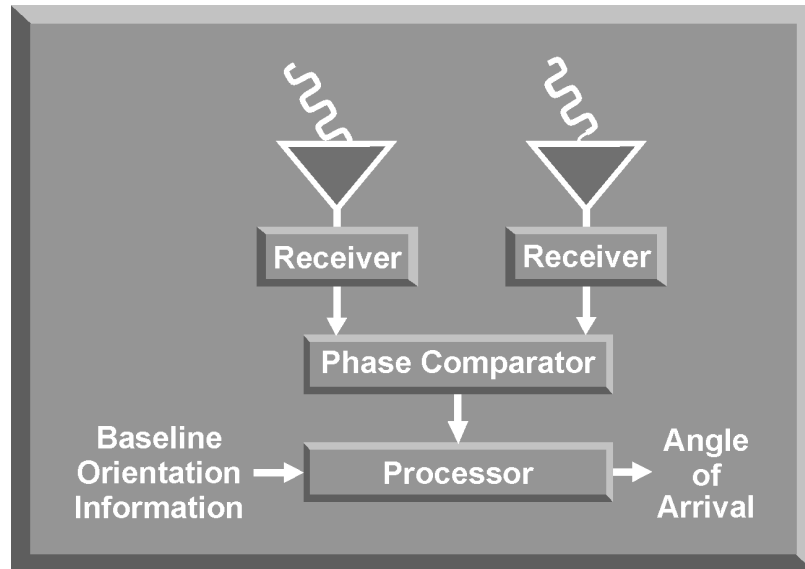

Figure 17-16. Interferometer Components

(2) To obtain rapid emitter locations some interferometer systems use multiple receive antennas in an array setup. This allows for simultaneous azimuth and elevation measurements to rapidly locate the emitter. An array allows for the mixing of long and short baselines in different patterns by selecting different pairs of antennas (Figure 17-17). The terms long baseline and short baseline are often used to designate the distance between the antenna elements in an interferometer system. Long baselines have the advantage of providing a quick and accurate location of the emitter, but they can suffer from ambiguities resulting from different wavefronts hitting the different antenna elements. In addition to the array depicted in Figure 17-17, a long baseline system could be created by using the existing RWR antennas on an aircraft, and supplementing these with a small short baseline system to compensate for the ambiguities.

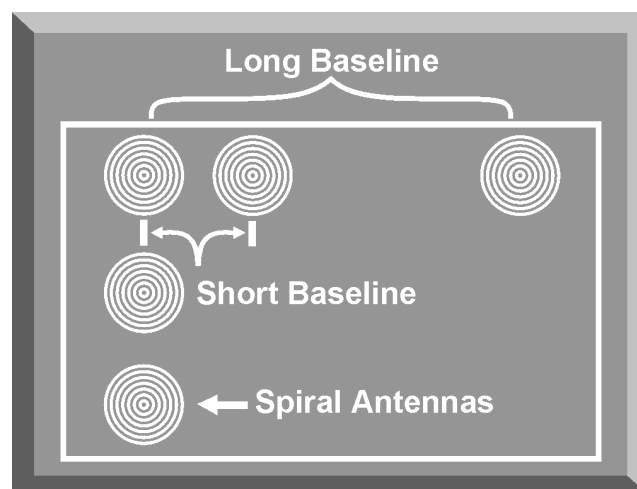

Figure 17-17. Interferometer Array

c. Time of arrival (TOA) and time difference of arrival (TDOA) techniques are the final type of location techniques to be covered in this section. Both techniques are based around the fact that radar signals travel at approximately the speed of light. Both techniques, using the speed of light as a constant, solve for the distance that the emitter is away from the receiver using the equation distance equals rate multiplied by time. Because there is not any directional information, the equation represents the radius of a circle around the receiving antenna; multiple distance measurements taken from multiple receivers are then overlaid. The intersection of the circles is the position of the emitter. If only two receivers are used, a simple DF technique can solve the ambiguity of which intersection represents the emitter (Figure 17-18).

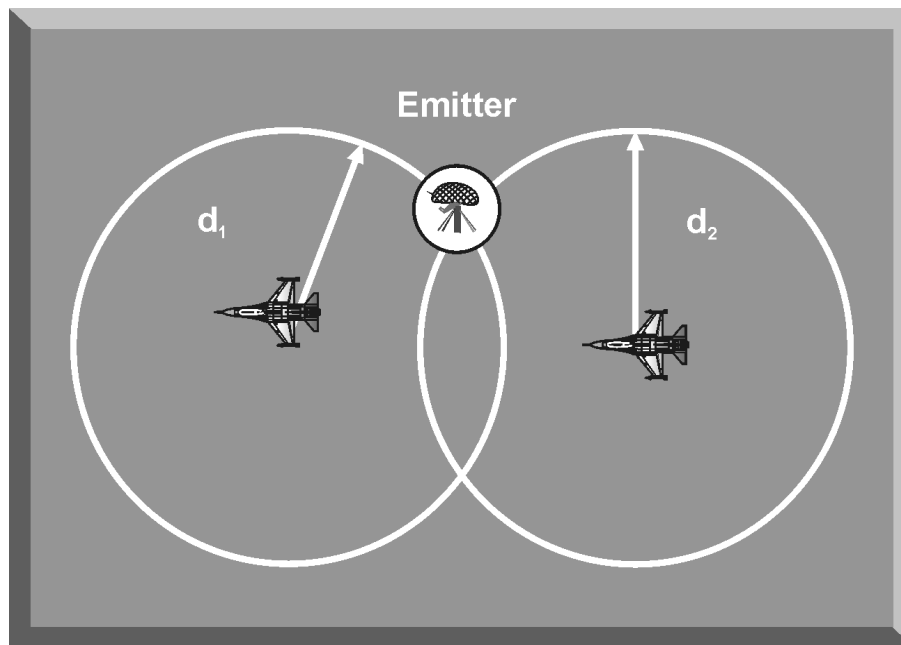

Figure 17-18. Time of Arrival Measurements

(1) TOA positioning is calculated by taking the time that a signal leaves a radar, measuring its arrival time at the receiver and mathematically solving for distance using the techniques described above. One of the primary challenges involved with TOA positioning is determining when the measured signal was transmitted, this requires either a very cooperative enemy or a radar signal with some type of exploitable time reference. Another challenge involves insuring that multiple receivers are timing the same signal. This is especially difficult in a threat intensive environment.

(2) TDOA is used when it is not possible to determine when a signal was transmitted. TDOA uses most of the same principles as TOA except that it must compensate for not knowing the time the signal was transmitted. It does this by using an extra receiver a known distance from the first receiver to generate a distance curve. The arrival of the signal is precisely measured at the two

receivers, the theory is that a signal that arrives at the two receivers at times t_1 and t_2 had to originate from a point on a curve defined by that difference in arrival time. For example, if the signal arrives at the two points at exactly the same time, then the transmitter must be equal distance from the two receivers. In this case the curve is actually a line of possible locations equal distance from the receivers and can easily be drawn. For situations where the signal arrives at different times at the receivers, a hyperbolic curve instead of a straight line denotes all the possible locations of the transmitter. Figure 17-19 shows an example of when the signal arrives at a different time, the constant value is the time difference multiplied by the speed of light yielding a distance. To solve for the emitter's location using TDOA another antenna receiver is required that is not in line with the first two receivers to generate an independent curve that will cross the first curve at the transmitter location.

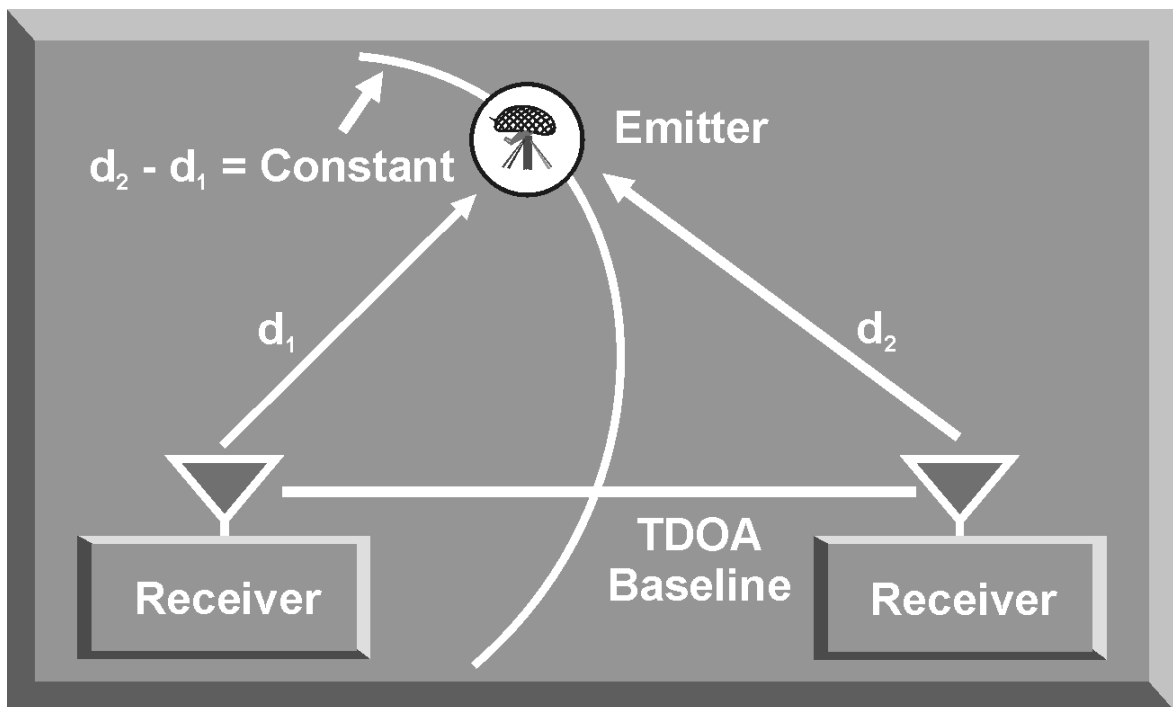

Figure 17-19. Time Difference of Arrival Measurements

(3) Timing techniques require very good timing accuracy in the receiving systems. If the receivers are far apart, such as different aircraft, then a separate time measurement is required at the source before sending to a processor. As with triangulation, one of the major challenges of multiple aircraft measurements is the coordination to ensure that the same signal is being looked at by all aircraft involved.

(4) Timing techniques are affected by the type of radar that they are trying to locate. Pure CW radars are not practical for a timing technique because there

is not a pulse to time. Pulsed signals, on the other hand, are much more susceptible to this type of location technique.

11. SUMMARY

An RWR system is designed to provide a picture of the electronic order of battle (EOB) operating in the vicinity of an aircraft. The signal processor is the heart of the RWR system and controls the function of all other system components. The signal processor, using inputs from the antennas and the receiver/amplifiers, compares the signal parameters with the parameters in the EID tables. The identified signals are displayed on the RWR scope with the appropriate audio. The ICU provides the aircrew interface with the signal processor to allow the aircrew to customize RWR operation for each combat mission. Modern RWR systems have some limitations that can effect aircrew survival. These limitations include ambiguous threat displays, maneuvering limitations, and EMI. Despite these limitations, an operational RWR system is one of the keys to survival on today's electronic battlefield. A product of advances on the electronic battlefield is rapid threat geolocation. New threat geolocation techniques are designed to provide advanced threat information to allow pilots to avoid, suppress, or destroy the mobile threat. The three most common techniques are basic triangulation using lines of bearing, interferometry using phase difference of arrival, and time difference of arrival using time differences to determine distance curves.

CHAPTER 18. SELF-PROTECTION JAMMING SYSTEM OPERATIONS

1. INTRODUCTION

Self-protection jamming systems are designed to counter surface-to-air missile (SAM), airborne interceptor (AI), and antiaircraft artillery (AAA) acquisition and target tracking radars. Self-protection jamming systems generate noise and deception jamming techniques to either deny threat system automatic tracking capability or generate sufficient tracking errors to prevent a successful engagement.

a. To counter the diverse array of threats and their associated frequencies in an integrated air defense system (IADS), a self-protection jamming system must be able to simultaneously jam multiple signals operating in a wide frequency range. The system must also be able to generate sufficient power to mask the radar return of the aircraft. Since many modern self-protection jamming systems are carried internally or externally on aircraft, their size, shape, and weight must be carefully controlled to minimize adverse effects on aircraft performance and handling. These design requirements may require a trade-off between additional power or capability and aircraft compatibility.

b. A self-protection jamming system must have receive antennas to receive radar signals, a system processor to identify received signals, a jamming techniques generator to produce an optimum jamming technique for the identified threat, and transmit antennas to transmit the required jamming techniques. These system components will be discussed in this chapter.

c. There are numerous internal and externally mounted self-protection jamming systems in use today. To simplify the discussion, the ALQ-184 pod will be used as an example of a modern, self-protection jamming system (Figure 18-1). The functions and operations of the ALQ-184 components are representative of currently deployed self-protection systems.

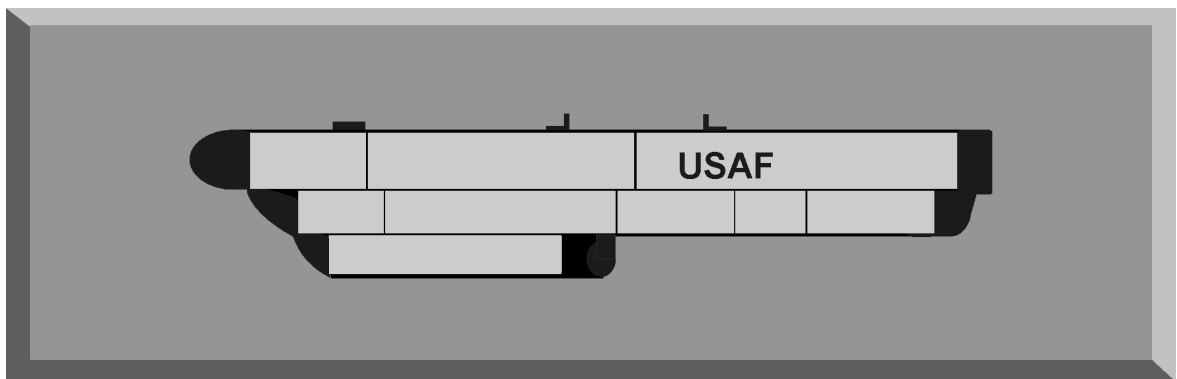

Figure 18-1. ALQ-184 Pod

2. RECEIVE ANTENNAS

The ALQ-184 pod has two sets of receive antenna assemblies located on the front and rear of the lower pod “gondola” (Figure 18-2). Each receive antenna assembly set consists of a low-band antenna and a mid/high-band antenna. The low-band antenna's signals are combined to form the input for the low-band receiver. The mid/high-band antennas provide signals to the separate mid/high-band portion of the pod.

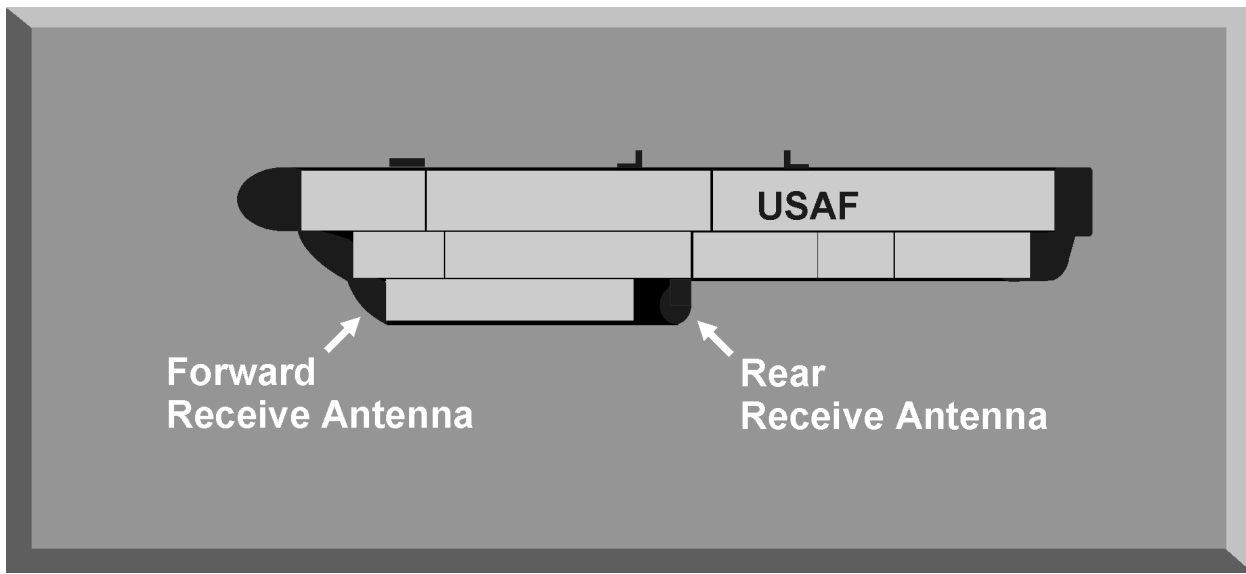

Figure 18-2. ALQ-184 Receive Antenna Location

a. The low-band receive antennas are circularly polarized spiral arrays. The mid/high-band receive antenna covers eight sub-bands via an eight element array that corresponds to the eight element transmit array. The mid/high-band antenna is also circularly polarized.

b. Each signal received via the receive antenna generates a corresponding transmit signal through a crystal video receiver. The angle of arrival (AOA) of each signal is determined by comparing the output of the crystal video receiver for each antenna.

3. RECEIVER SECTION

The forward and aft receive antennas detect radar signals and send them to the receiver section. The receiver section contains an AOA receiver and a multiplexer that separates frequencies. The AOA receiver determines the AOA of a signal based on the output signal level of each antenna element. The AOA data is passed to the system processor to control the angle of transmission of the jamming signal. The multiplexer separates all received threat signals into eight frequency sub-bands consisting of five mid-band and three high-band frequency

ranges. The multiplexer categorizes the received radar signals by sub-band and azimuth and then sends them to the system processor and the exciter.

4. SYSTEM PROCESSOR

The system processor is the “brain” of the ALQ-184 pod. It receives the threat signals from the receiver section that have already been categorized by sub-band and distinguished by AOA. Each received signal and its corresponding AOA is counted. When the signal count exceeds a pre-set threshold, the system processor validates the signal and identifies it using the emitter identification (EID) tables. Based on this threat identification, the system processor directs the techniques generator to initiate a jamming program through the exciter. At the same time, the system processor, through a signal switch control, directs the transmitter section to use either the forward or aft transmit antenna array, and specifies the transmit angle for the jamming program based on AOA.

a. The system processor also controls the low-band portion of the pod (Figure 18-3). The forward or aft low-band antenna receives and combines the threat signal and sends it to the multiplexer. The multiplexer channelizes this signal into one of two low sub-bands. The signal then passes to the modulator where the voltage controlled oscillators (VCOs) generate a jamming technique as directed by the system processor techniques generator. This ensures the jamming technique is at the proper frequency and modulation to provide maximum effect against the threat system. The generated jamming signal passes to a second multiplexer and then to a solid state amplifier for amplification. The amplified jamming signal is then sent to the two low-band traveling wave tubes (TWTs) and transmitted from the forward and aft low-band transmit antennas.

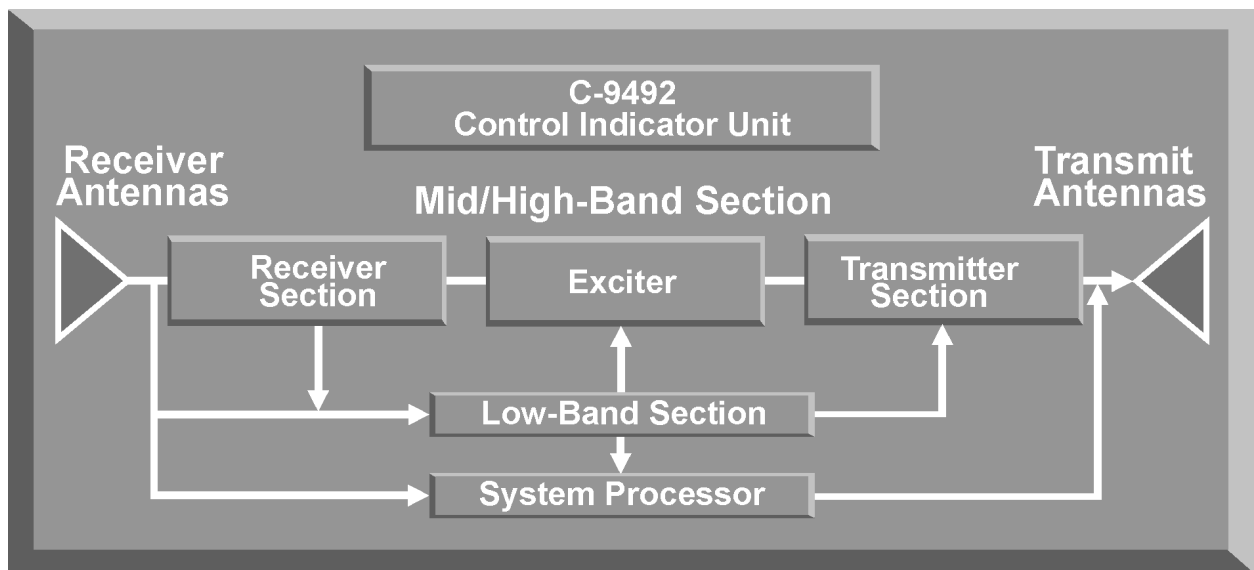

Figure 18-3. ALQ-184 Simplified Block Diagram

b. The system processor periodically performs a background built-in-test (B-BIT), to check the status and calibration of the ALQ-184. The system processor software is updated or reprogrammed as required from a memory loader verifier (MLV). The system processor uses two major software programs. The operational flight program (OFP) manages the receiver and transmitter functions, signal processing, and techniques generation. The mission data generator (MDG) contains the threat EID tables and the jamming techniques matrix for these threats.

5. JAMMING TECHNIQUES GENERATOR

The exciter section contains the VCOs and the keyed oscillators, which generate the jamming waveforms that are directed by the system processor. The exciter takes the threat signal from the receiver and modifies it with deception modulation or generates a noise program based on the techniques generator in the system processor. The selected jamming technique is then sent to the transmitter section.

6. TRANSMIT ANTENNAS

The transmitter section contains antenna switching circuits, a signal forming network, and TWTs. The antenna switching circuits are controlled by the system processor to ensure the transmitted jamming pulse is radiated at the proper azimuth. The signal-forming network controls the phase of each jamming signal. There are sixteen TWTs in the transmitter section, one for each front and aft antenna. The TWTs amplify the jamming signal for transmission from the appropriate transmit antenna.

a. The ALQ-184 has two sets of transmit antenna assemblies. One set is located on the front and one on the rear of the main pod assembly (Figure 18-4).

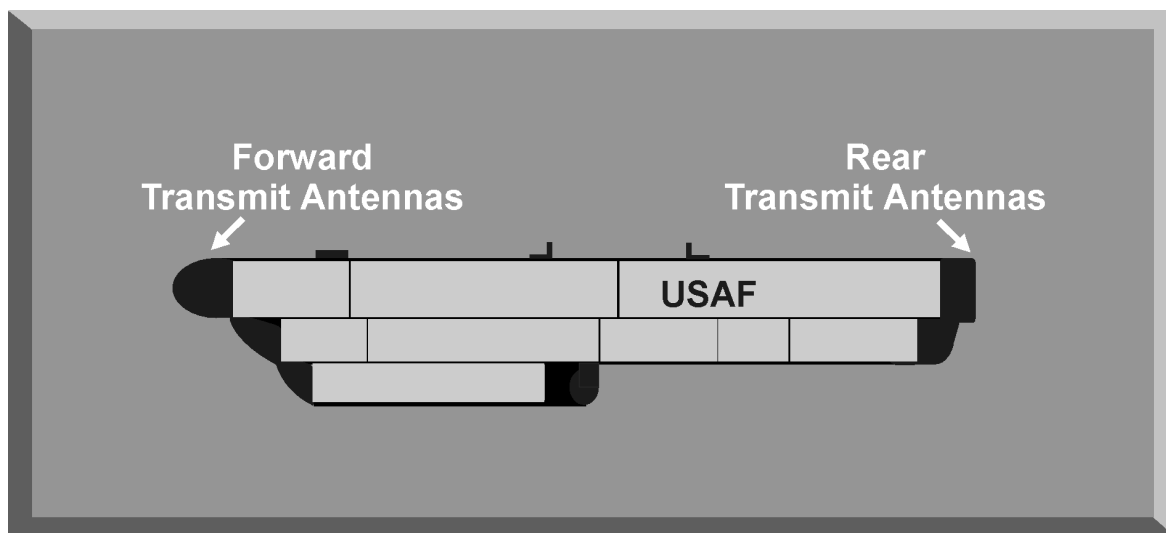

Figure 18-4. ALQ-184 Transmit Antenna Location

Each set has a low-band and mid/high-band antenna. The transmit antennas have opposite polarization from the receive antennas. This enables the pod to transmit and receive at the same time while preventing pod “ringing.” Ringing occurs when the pod receives its own jamming signal and generates a jamming program to counter its own signal. This condition can highlight the aircraft to enemy radar and seriously degrade pod effectiveness.

b. The low-band transmit horn antennas are circularly polarized. The mid/high-band transmit antennas have the same eight-element array as the receive antennas. The transmit antennas generate a directional jamming signal for pulsed radar signals based on the AOA determined by the receive antennas. Detailed information on the antenna jamming pattern is contained in the ALQ-184 ECM Handbook.

7. C-9492 CONTROL INDICATOR UNIT

The C-9492 Control Indicator Unit (CIU) provides control of all functions of the ALQ-184. It allows the aircrew to control system power, select jamming techniques, and monitor system status (Figure 18-5).

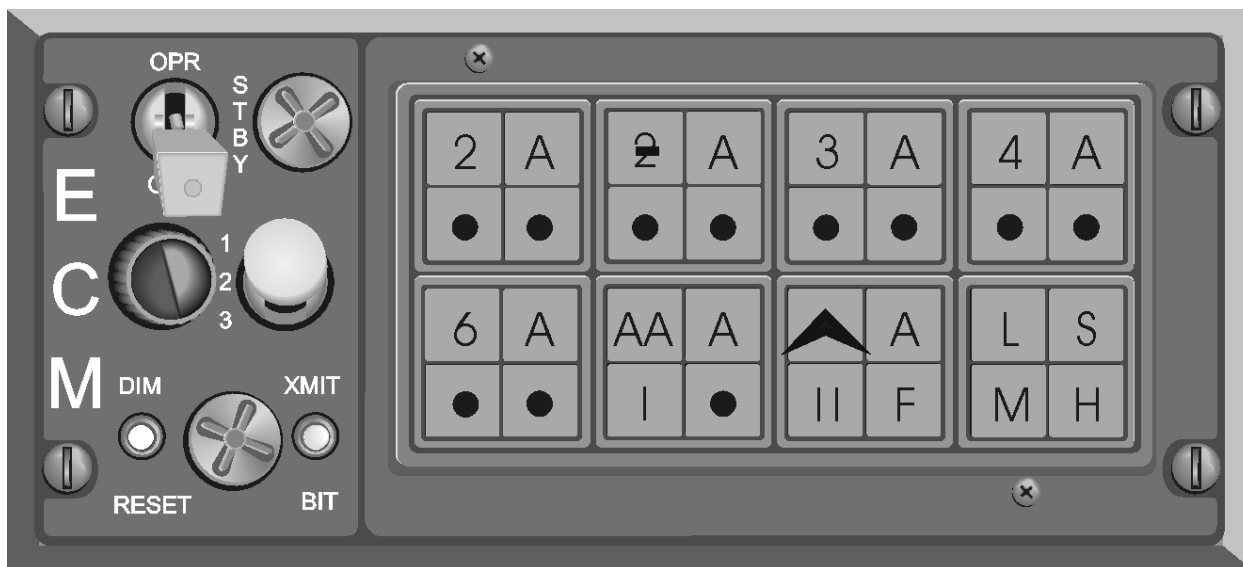

Figure 18-5. C-9492 Control Indicator Unit

8. JAMMING POD CONSIDERATIONS

Unfortunately, jamming pods do not make the aircraft completely invisible from enemy threat systems. When used in conjunction with the RWR, expendables, and threat countertactics they do drastically increase the probability of surviving a threat engagement. This section contains some items of consideration to ensure that your self-protection jamming is being properly utilized. These considerations include highlighting, burnthrough, and reprogramming.

a. If used improperly a self-protection pod can actually highlight the aircraft. This happens when a pod transmits a jamming program constantly or when another type of radar, not targeted for jamming but in the same frequency range, sees the jamming. Highlighting is normally associated with noise programs that transmit constantly. Most pods today avoid this by transmitting only when a threat requires it. Additionally, some aircraft have pod inhibit switches that allow the pod to remain in a standby condition until the pilot switches the pod to operate. What makes this system effective is that the switch is either on the stick or throttle allowing the pilot to rapidly go to operate without looking inside the cockpit (Figure 18-6).



Figure 18-6. F-16 ECM CMS

b. Burnthrough is described as the range that the aircraft's radar return is stronger than its jamming signal. Basically, the jet has gotten so close to the threat radar that the threat radar is overpowering the jamming pod. The range that this occurs varies for different radars, but it should be planned for particularly when there are threats in the target area. Burnthrough is also a consideration for support jamming systems; there is a range at which the support jammer's signal will be overpowered and the protected aircraft can be seen.

c. Many self-protection jamming systems are what is called software-reprogrammable. This means that jamming programs can be rapidly changed to adjust for changes in enemy radar systems. These updates can be made to

systems while they are still on the jet, and can take as little as 15 minutes using an MLV. The process of changing electronic warfare systems is known as a Pacer Ware change. An exercise to check the ability to make changes is known as a Serene Byte exercise. The pilot of the aircraft carrying the self-protection system has one responsibility in this process: to ensure that his jamming system is carrying the most current software program, usually referred to as a software version. While Pacer Ware changes are not common during peacetime operations, they do happen quickly during combat operations often to fine tune the jamming systems for the particular theater of combat.

9. SUMMARY

The effective employment of self-protection jamming is one of the factors that can mean the difference between success and failure on the modern battlefield. When employed in concert with chaff and maneuvers, self-protection jamming can be extremely effective in negating potentially lethal attacks. Despite their limitations, self-protection jamming systems are an important part of the “bag of tricks” aircrews can employ to put bombs on target.

ANNEX A GLOSSARY

Absorption - Dissipation of energy of electromagnetic waves, sound, and light waves into other forms of energy because of interaction with matter. Absorption characteristics of specific materials are used as blankets, coatings, or structural and surface materials for aircraft to reduce effective radar cross-sections.

Acoustic jamming - The deliberate radiation of mechanical or electro-acoustic signals with the objectives of obliterating or obscuring signals which the enemy is attempting to receive, and of deterring enemy weapon systems.

Acquire –

1. When applied to acquisition radars: the process of detecting the presence and location of a target in sufficient detail to permit identification.

2. When applied to tracking radars: the process of positioning a radar beam so that a target is in that beam to permit the effective employment of weapons.

Acquisition radar - A radar set that detects an approaching target and feeds approximate position data to a fire control or missile guidance radar that then takes over the function of tracking the target.

Active array radar - A phased array radar in which each radiating element contains a transmitter and receiver front end, as opposed to a single transmitter/receiver serving all phased array elements. Advantages attributed to active array radars include efficient use of prime power, no waveguide losses, very wide bandwidth, and extreme reliability due to the lack of single point of failure.

Active homing guidance - A system of homing guidance in which both the source for illuminating the target, and the receiver for detecting the energy reflected from the target as the result of illumination, are carried within the missile.

Aerosols - Solid particles dispersed in the atmosphere that have resonant size particles with a high index of refraction. The particles both scatter and absorb visual and laser-directed energy so as to lessen the effect of weapon systems directed by these techniques.

Airborne early warning and control - Air surveillance and control provided by airborne early warning vehicles that are equipped with search and height finding radar and communications equipment for controlling weapons.

Airborne interceptor (AI) - A manned aircraft used for identification and/or engagement of airborne objects. (An AI may or may not be equipped with radar to assist in the interception.)

Airborne Warning and Control System (AWACS) - An aircraft suitably equipped to provide control, surveillance, and communications capability for strategic defense and/or tactical air operations.

Air defense - All defensive measures designed to destroy attacking enemy aircraft or missiles in the earth's envelope of atmosphere, or to nullify or reduce the effectiveness of such attack.

Air surveillance radar (ASR) - A radar displaying range and azimuth that is normally employed in a terminal area as an aid to approach and departure control.

Air-to-air missile (AAM) - A missile launched from an airborne carrier at a target above the surface.

Air-to-surface missile (ASM) - A missile launched from an airborne carrier to impact on a surface target.

Alternating current (AC) - An electric current that reverses its direction at regularly recurring intervals, the frequency being determined by the frequency of the alternator supplying the current.

AM-CW jamming - Jamming in which a carrier wave is modulated at a constant recurring rate. The recurrence rate of amplitude modulation is variable, and reflects a noticeable change in the radar scope. Because of the spiraling or chaining effect produced, AM-CW jamming is easily identified.

Amplifier - An electronic circuit usually used to obtain amplification of voltage, current, or power.

Amplitude shift keying - A method of impressing a digital signal upon a carrier signal by causing the carrier amplitude to take different values corresponding to the different values of the digital signal.

Amplitude modulation (AM) - A method of impressing a message upon a carrier signal by causing the carrier amplitude to vary proportionally to the message waveform.

Angle jamming - A deception jamming technique used to deny azimuth and elevation information to a TTR by transmitting a jamming pulse similar to the radar pulse, but with modulation information out of phase with the returning target azimuth modulation information.

Angle tracking - Accomplished through the use of pulses to determine angular definition of a target.

Antenna - A device used for transmitting or receiving RF energy. The function of the antenna during transmission is to concentrate the radar energy from the transmitter into a shaped beam that points in the desired direction. During reception, or listening time, the function of the antenna is to collect the returning radar energy, contained in the echo signals, and deliver these signals to the receiver. Radar antennas are characterized by directive beams that are usually scanned in a recognizable pattern. The primary radar antenna types in use today fall into three categories: parabolic, Cassegrain, and phased array antennas.

Antenna cross talk - A measure of undesired power transfer through space from one antenna to another. Ratio of power received by one antenna to power transmitted by the other usually expressed in decibels.

Antenna gain - See Gain

Antenna polarization - See Polarization

Antenna sidelobes - See Sidelobes

Antiaircraft artillery (AAA) - Guns used to shoot unguided projectiles at airborne aircraft. Usually used in the air defense system.

Anti-clutter circuits (in radar) - Circuits that attenuate undesired reflections to permit detection of targets otherwise obscured by such reflections.

Antiradiation missile (ARM) - A missile that homes passively on a radiation source.

Area defense - The concept of locating defense units to intercept enemy attacks, remote from, and without reference to, individual vital installations, industrial complexes, or population centers.

Asynchronous pulsed jamming - An effective form of pulsed jamming where the jammer nearly matches the PRF of the radar then transmits multiples of the PRF. It is more effective if the jammer pulse width is greater than that of the radar. Asynchronous pulsed jamming is similar to synchronous jamming except that the target lines tend to curve inward or outward and appear fuzzy in the jammed sector of the radar scope.

Attenuation - The decrease in amplitude of a signal during its transmission from one point to another. Attenuation increases as distance increases. The higher the frequency of the propagating signal, the higher the rate of attenuation.

Automatic frequency control (AFC) - Circuits in a receiver that automatically correct the local oscillator frequency to prevent receiver drift in tuned frequency.

Automatic gain control (AGC) –

1. A feature involving special circuitry designed to maintain the output of a radio, radar, or television receiver essentially constant, or to prevent its exceeding certain limits, despite variations in the strength of the incoming signal. In a radio receiver, in particular, though something of a misnomer, also known as automatic volume control.

2. A self-acting compensating device that maintains the output of a transmission system constant with narrow limits, even in the face of wide variations in the attenuation of the system.

3. A radar circuit that prevents saturation of the radar receiver by long blocks of receiver signals, or by a carrier modulated at low frequency.

Automatic search jamming - An intercept receiver and jamming transmitting system that automatically searches for and jams enemy signals of specific radiation characteristics.

Automatic tracking - Tracking in which a system employs some mechanism, e.g., servo or computer, to automatically follow some characteristics of the signal.

Azimuth resolution - The ability of a radar to distinguish two targets in close azimuth proximity and distance.

Backlobe - The portion of the radiation pattern of an antenna that is oriented 180° in relation to the main beam. The antenna backlobe is a result of diffraction effects of the reflector and direct leakage through the reflector surface.

Backward wave oscillator (BWO) - A special traveling wave tube in which oscillatory currents are produced by using an oscillatory electromagnetic field to bunch the electrons as they flow from cathode to anode.

Ballistic missile - Any missile that does not rely upon aerodynamic surfaces to produce lift and consequently follows a ballistic trajectory when thrust is terminated.

Bandpass filter - A filter that allows a select range of frequencies to pass while attenuating all frequencies outside the range.

Bandwidth - The range of frequencies within which performance, with respect to some characteristics, falls within specific limits (i.e., the width of frequency of a barrage noise package).

Barrage noise jamming - Noise jamming spread in frequency to deny the use of multiple radar frequencies to effectively deny range information. Although this is attractive because it enables one jammer to simultaneously jam several radars of different frequencies, it does have the inherent problem that the wider the jamming spread, the less jamming power available per radar.

Beam rider - A missile guided by an electronic beam.

Beam-to-beam correlation (BBC) - Used by frequency scan radars to reject pulse jamming and jamming at swept frequencies. Correlation is made from two adjacent beams (pulses). The receiver rejects those targets (signals) that do not occur at the same place in two adjacent beams.

Beamwidth - The width of a radar beam measured between lines of half-power points on the polar pattern of the antenna. This width is measured at the 3 dB points.

Beat frequency oscillator (BFO) - Any oscillator whose output is intended to be mixed with another signal to produce a sum or difference beat frequency. Used particularly in reception of CW transmissions.

Bistatic radar - A radar where the transmitting and receiving antennas are separated by a considerable distance. Bistatic operation provides several advantages for its user. The covert positioning of the receivers poses problems for a potential attacking force since ELINT techniques locate the transmitter not the receiver. The proper placement of jamming assets is difficult, since the receiving sites are unknown. In addition, if a stand-off jammer is directed at the transmitter, its effectiveness in the direction of the covert receiver is diminished.

Jammers not in the same beam as the wanted targets will be attenuated by the receiver's sidelobe protection and these targets will be more readily detected.

Blanking –

1. The cutting off of the electronic beam in a cathode-ray tube when the picture is not being formed. The beam is blanked while the spot is returning to the starting position (normally right to left).

2. Process of making a channel or device noneffective for a desired interval.

Blinking - A jamming technique employed by two aircraft separated by a short distance and within the same azimuth resolution to appear as one target to a tracking radar. The two aircraft alternately spot jam, causing the radar system to oscillate from one plane to another, making an accurate solution of fire control problem impossible. However, keep in mind that too high a blinking frequency can cause the tracker to average the data while too low a frequency will cause a missile to home-in on one of the jammers.

Broad pulse jamming - Transmission of broad pulses for control system jamming when little is known about the command pulse group. For example, a broad pulse might cover a whole group of command pulses, thus jamming that command.

Burnthrough range - The ability of a radar to see through jamming. Usually described as the point when the radar's target return is stronger than the jamming signal.

Burst chaff - The formation of a reflective volume of chaff from an individual bundle.

Buzzer - Code name for airborne jamming.

Capture - Where the jammer takes control over the guidance signal by active jamming.

Capture effect - The tendency of a receiver to suppress the weaker of two signals within its bandpass.

Capture of AGC - Domination of the radar's automatic gain control (AGC) level by a strong transmitted jamming signal.

Carrier frequency - Frequency of an unmodulated radio wave emanated from a radio, radar, or other type of transmitter.

Carrier wave - Electromagnetic radiation used to “carry” information from one point to another.

Centroid homing - When applied to antiradiation missiles, the effect on a missile that has two or more radiation sources in its field of view causing it to home on the centroid of the power from the radiating sources.

Chaff - Ribbon-like pieces of metallic materials or metalized plastic that are dispensed by aircraft to mask or screen other aircraft or to cause a tracking radar to break lock. The foil materials are generally cut into small pieces for which the size is dependent upon the radar interrogation frequency (approximately 1/2 wavelength of the victim radar frequency). Being 1/2 wavelength long, chaff acts as a resonant dipole and reflects much of the energy back to the radar.

Chaff corridor - Operational technique of dropping large quantities of chaff for a continuous period of time. This results in a “ribbon” or “stream” of returns many miles long on radar scopes. The penetrating strike force can then use the resulting chaff corridor to mask its penetration.

Chirp - A pulse compression technique characterized by linear frequency modulation on pulse (LFMOP).

Chirp radar - Radar in which a swept-frequency signal is transmitted, received from a target, and then compressed in time to give a final narrow pulse called the chirp signal. It has high immunity to jamming and an inherent rejection of random noise signals.

Circularly polarized jamming - The techniques of radiating jamming energy in both planes of polarization. With this method, there is a 3-dB loss of effective power in either plane, but the enemy cannot cross-polarize his antenna to escape jamming.

Circular scan - The pattern generated by an antenna that is continuously rotating in one direction.

Clipped noise modulation - A clipping action is performed to increase the bandwidth of the jamming signal. Results in more energy in the sidebands, correspondingly less energy in the carrier, and an increase in the ratio of average power to peak power.

Clutter - Unwanted signals, echoes, or images on the face of a scope that interferes with the observation of desired signals. Also called noise. This tends to mask the true target from detection or cause a tracking radar to break lock.

Clutter elimination - The clutter eliminator circuit discriminates against any target echo that exceeds three times the transmitted pulse width, and will not display it on the indicator. It is normally employed on the lower beams of a high frequency radar. This will allow targets above a preset signal strength to be presented, while the clutter (land) will be eliminated.

Clutter gating - A technique that provides switching between MTI and normal videos. It results in the normal video being displayed in regions with no clutter and the MTI video being switched in only for the clutter areas. Clutter gating is achieved automatically by the PW discrimination or the use of storage tubes. It also can be achieved by a manually operated range azimuth gate. The clutter gate vastly increases the effectiveness of noncoherent MTI against chaff.

Coherent MTI (in radar MTI) - A system in which the target echo is selected based on its Doppler frequency when compared to a local reference frequency maintained by a coherent oscillator.

Coherent noise jamming - Noise-like jamming signal that is repetitive and in synch with the PRI of the radar.

Coherent repeater jammer - A jammer that uses the phase information of the receiver radar signal in creating false targets thus transmitting a signal that is acceptable to the receiver processor of a victim coherent radar.

Command and control warfare (C2W) - The integrated use of operations security (OPSEC), military deception, psychological operations (PSYOP), electronic warfare (EW), and physical destruction, mutually supported by intelligence to deny information, influence, degrade, or destroy adversary C² capabilities while protecting friendly C² capabilities.

Command, control, communications, and computer systems (C4) - The process of, and means for, the exercise of authority and direction by a properly designated commander over assigned forces in the accomplishment of the commander's mission.

Command guidance - A guidance system in which intelligence transmitted to the missile from an offboard source causes the missile to traverse a directed flight path.

Communications intelligence (COMINT) - Intelligence derived from the interception of enemy communications signals.

Communications security (COMSEC) - The protection resulting from all measures designed to deny unauthorized persons information of value that might be

derived from the possession and study of telecommunications, or to mislead unauthorized persons in their interpretation of the results of such possession and study. COMSEC includes: 1. Cryptosecurity; 2. transmission security; 3. emission security; and 4. physical security of communications security material and information.

1. **Cryptosecurity** - The component of communications security that results from the provision of technically sound cryptosystems and their proper use.

2. **Transmission security** - The component of communications security from which all measures designed to protect transmissions from interception and exploitation by means other than cryptoanalysis.

3. **Emission security** - The component of communications security that results from all measures taken to deny unauthorized persons information of value that might be derived from intercept and analysis of compromising emanations from crypto equipment and telecommunications systems.

4. **Physical security** - The component of communications security that results from all physical measures necessary to safeguard classified equipment, material, and documents from access thereto or observation thereof by being within a friendly power.

Complex pulse - A pulse train in which there is more than one pulse width and/or more than one pulse repetition interval.

Conformal antenna - An antenna which conforms to a surface whose shape is determined by considerations other than electromagnetic, for example, an antenna shaped to aerodynamically fit the side of an aircraft.

Conical scan (CONSCAN) - A type of scanning in which the axis of the RF beam is tilted away from the axis of the reflector and rotated about it, thus generating a cone.

Constant false alarm rate (CFAR) receiver - A radar receiver with automatic detection circuits designed to produce a constant number of erroneous target detections independent of noise level at the receiver input. CFAR techniques are intended to prevent receiver saturation and overload, to present clear video information to the display, and a constant noise level to an automatic detector. A device that accomplishes these objectives may respond to the signal-to-noise ratio, for example, rather than the absolute signal level above a fixed threshold. CFAR does not usually permit the detection of a target if the target is weaker than the jamming, but it does attempt to remove the confusing jamming effects.

Continuous wave (CW) - A constant, single-frequency, unmodulated carrier wave that is transmitted and then reflected. A good system for determining velocity.

Correlation detection (modulation systems) - Detection based on the averaged product of the received signal and locally generated function possessing some known characteristics of the transmitted wave. Note the following caveats:

1. The averaged product can be formed, for example, by multiplying and integrating, or by using a matched filter whose impulse response, when reversed in time, is the locally generated function.

2. Strictly, the above definition applies to detection based on cross-correlation. The term correlation detection may also apply to detection involving autocorrelation, in which case the locally generated function is merely a delayed form of the received signal.

Countdown - A technique for forcing the radar AGC to continuously change value and oscillate. The jammer rapidly changes the duty cycle of the deception pulses.

Countdown blink - Self-screening AGC deception using a gated repeater or noise source; the period of which is short compared to the victim's AGC time constant.

Cover pulse - A jammer covers the radar return with an AM pulse usually much wider than the radar pulse. Since tracking circuits are looking for largest return, they will transfer to the cover pulse, thereby denying range information.

Cross-eye - A jamming technique used to produce angular errors in monopulse and other passive lobing radars. Jammer is a two-source interferometer that causes the phase front of the signal reaching the radar to be highly distorted. With such a technique, it is difficult for the radar to determine the points from which the transmissions are originating. Requires a high jam-to-signal ratio or the skin echo will show up in the pattern nulls.

Cross-gated CFAR - A CFAR technique employed to achieve the fast switching required for an optimum combination of normal and MTI modes. Here, the MTI video signals are used to "gate" on the normal video when the MTI indicates a target in clutter. CFAR action is achieved by the wideband as in the zero-crossing and Dicke fix CFARs.

Cross polarization - or "Cross Pole," is a monopulse jamming technique where a cross-polarized signal is transmitted to give erroneous angle data to the radar. The component of the jamming signal with the same polarization as the radar must be very small.

Cross polarization jamming - A technique whereby the received signal is retransmitted cross-polarized and at a much higher power than the skin return-effective against some monopulse radars by generating erroneous angle information.

CW jamming - The transmission of constant-amplitude, constant-frequency, unmodulated jamming signals to change the signal-to-noise ratio of a radar receiver.

Data link - A communications link which permits automatic transmission of information in digital form.

Deception - Those measures designed to mislead the enemy by manipulation, distortion, or falsification of evidence to induce him to react in a manner prejudicial to his interests. (See Electronic Deception, or Manipulative Deception.)

Deception jamming - Any means of jamming consisting of false signals that have similar characteristics to the victim radar thereby deceiving the operator into erroneous conclusions.

Decibel (dB) - A dimensionless unit for expressing the ratio of two values, the number of decibels being 10 times the logarithm to the base 10 of a power ratio, or 20 times the logarithm to the base 10 of a voltage or current ratio. A power increase by 3 dB indicates a doubling of the original power.

(dBm) - Same as dBw except the reference level is one milliwatt instead of one watt.

(dBw) - Unit used to describe the ratio of the power at any point in a transmission system to a referenced level of one watt. The ratio expresses decibels above and below the reference level of one watt.

Defense suppression - A term applied to weapons systems that are intended to eliminate or degrade enemy detection, acquisition, or tracking equipment.

Delayed opening chaff - Chaff that blooms at a specific elapsed time after it is dispensed.

Detector balanced bias - Controlling circuit used in radar systems for anti-clutter purposes.

Dicke fix - A technique specifically designed to protect the receiver from ringing caused by noise, fast-sweep, or narrow-pulse jamming. The basic configuration

consists of a broadband limiting IF amplifier, followed by an IF amplifier of optimum bandwidth. The limit level is preset at approximately the peak amplitude of receiver noise. The bandwidth may vary from 10 to 20 MHz, depending on the jamming environment. The device provides excellent discrimination against fast-sweep jamming (10 - 500 MHz), usually something about 20 to 40 dB, without appreciable loss in sensitivity. However, strong CW jamming will seriously degrade the performance of the Dicke fix because the CW signal captures the radar signal in the limiter.

Dicke fix CFAR - Constant False Alarm Rate.

Dicke fix MT CFAR - An MTI CFAR technique similar to Dicke fix CFAR. Limiting and narrowbanding follow wideband amplification, phase detection, and cancellation so as not to impair the MTI performance.

Digital radio frequency memory (DRFM) - A computer-controlled digital device used in radar jamming systems. DRFM provides an extremely fast and accurate storage capability for victim radar signal parameters. Jamming systems employing DRFM can rapidly and accurately generate coherent jamming based on the memorized victim radar signal.

DINA - See Direct Amplified Noise.

Diode - An electron device having two electrodes, a cathode, and an anode.

Diplex - Two transmitters operating alternately on approximately the same RF and using a common antenna. The normal procedure is to pulse each transmitter at $\frac{1}{2}$ the desired PRF, 180° out-of-phase. The advantage is that higher peak power per transmitter is possible because each transmitter is operating at $\frac{1}{2}$ the normal duty cycle.

Dipole antenna - A straight, center-fed, $\frac{1}{2}$ wavelength antenna. Horizontally polarized, it produces a figure-eight radiation pattern with maximum radiation at right angles to the plane of the antenna.

Direction finding (DF) - A procedure for obtaining bearings of radio frequency emitters with the use of a highly directional antenna and a display unit on an intercept receiver or ancillary equipment.

Direct amplified noise (DINA) - DINA without a carrier frequency is used for increasing (saturating) the radar receiver's noise level. This is called video stealing. The biggest danger from this type of jamming is that the radar operator may not realize he is being jammed when automatic gain control (AGC) or automatic noise leveling (ANL) are employed. This is a barrage type of jamming

with a bandwidth normally more than 50 MHz. DINA appears as a bright, high intensity wedge when the manual gain is employed. Thus, all useful radar scope information is lost.

Doppler (effect) - Continuous wave (CW) Doppler radar modules are sensors that measure the shift in frequency created when an object moves. A transmitter emits energy at a specific frequency which, when reflected, can indicate both speed and direction of the target. When objects move closer to the Doppler source, they increase in shift (positive value), and when they move further away, they decrease in shift (negative value).

Doppler radar - A radar system that measures the velocity of a moving object by the apparent shift in carrier frequency of the returned signal as it approaches or recedes.

Downlink - The signal from a transponder beacon located on a surface-to-air missile (SAM) used to provide a traceable radar return for missile guidance.

Downlink jamming (DLJ) - Some command guidance missiles carry a beacon (downlink) which is used by the parent radar to track the missile. If this beacon reply can be hidden from the parent tracking radar, the missile guidance solution can be defeated. Hence, downlink (beacon) jamming is intended to screen the missile beacon signal from the parent radar's view.

Ducting - The bending of radar rays due to atmospheric conditions. Ducting can either extend radar coverage beyond normal line of sight or it can deny the radar picture above a duct. Ducting is also called Anomalous Propagation.

Dummy antenna - A device that has the necessary impedance characteristics of an antenna and the necessary power-handling capabilities, but does not radiate or receive radio waves. Note: In receiver practice, that portion of the impedance not included in the signal generator is often called a dummy antenna.

Dummy load (radio transmission) - A dissipative but essentially nonradiating substitute device having impedance characteristics simulating those of the substituted device. This allows power to be applied to the radar unit without radiating into free space.

Duplex - In radar, a condition of operation when two identical and interchangeable equipments are provided—one in an active state, and the other immediately available for operation.

Duplexer - A switching device used in radar to permit alternate use of the same antenna for both transmitting and receiving.

Duty cycle - The ratio of the time the transmitter is actually on versus the time it could be on in a given transmission cycle. Mathematically, it can be expressed as:

$$\text{Duty Cycle} = \frac{\text{PD}}{\text{PRT}} \quad \text{or} \quad \text{Duty Cycle} = \text{PD} \times \text{PRF}$$

Dynamic range –

1. The difference, in decibels, between the overload level and the minimum acceptable signal level in a system or transducer. Note: The minimum acceptable signal level of a system or transducer is ordinarily fixed by one or more of the following: noise level, low-level distortion, interference, or resolution level.

2. Ratio of the specified maximum signal level capability of a system or component to its noise or resolution level, usually expressed in decibels.

Early warning radar - A radar set or system used near the periphery of a defended area to provide early notification of hostile aircraft approaching the area.

EA pod - A jamming system that is designed to be carried externally on an aircraft.

Effective radiated power (ERP) - Input power to antenna time multiplied by the gain of the antenna, expressed in watts.

Electromagnetic interference (EMI) - Any electromagnetic disturbance that interrupts, obstructs, or otherwise degrades or limits the effective performance of electronic systems. EMI can be induced intentionally, by way of jamming, or unintentionally because of spurious emissions and modulations.

Electromagnetic pulse (EMP) - The generation and radiation in a transmission medium of a very narrow and very high-amplitude pulse of electromagnetic noise. The term is associated with the high-level pulse because of a nuclear detonation and with an intentionally generated narrow, high-amplitude pulse for EA applications. In nuclear detonations, the EMP signal consists of a continuous spectrum with most of its energy distributed throughout the low frequency band of 3 to 30 kHz.

Electromagnetic radiation - Radiation made up of oscillating electric and magnetic fields and propagated with the speed of light. Includes gamma radiation, x-rays, ultraviolet, visible and infrared radiation, plus radar and radio waves.

Electromagnetic spectrum - The total range of frequencies (or wavelengths) over which any form of electromagnetic radiation occurs.

Electromagnetic test environment (EMTE) - A range complex of radars, such as those located at Eglin AFB, FL, operating in different frequency bands and modes to provide a very flexible test facility for evaluating aircraft antenna patterns, reflectivity measurements, infrared, reconnaissance, airborne interceptors, and electronic warfare devices and techniques.

Electronic attack (EA) - The use of electromagnetic energy, directed energy, or antiradiation weapons to attack personnel, facilities, or equipment with the intent of degrading, neutralizing, or destroying enemy combat capability. Action taken to reduce the enemy's effective use of the electromagnetic spectrum. EA is a division of electronic warfare (EW).

Electronic combat (EC) - Action taken in support of military operations against the enemy's electromagnetic capabilities. EC is task-oriented and includes electronic warfare (EW), command and control warfare (C2W), and suppression of enemy air defenses (SEAD).

Electronic protection (EP) - Active and passive means taken to protect personnel, facilities, and equipment from any effects of friendly or enemy employment of electronic warfare that degrade, neutralize or destroy friendly combat capability. EP is a division of electronic warfare (EW).

Electromagnetic deception - The deliberate radiation, reradiation, alteration, absorption, or reflection of electromagnetic radiations in a manner intended to mislead an enemy in the interpretation of, or use of, information received by his electronic systems. There are two categories of electronic deception:

1. **Manipulative deception** - The alteration or simulation of friendly electromagnetic radiation to accomplish deception.

2. **Imitative deception** - The introduction of radiations into enemy channels that imitate his own emissions.

Electronic intelligence (ELINT) - The intelligence information product of activities engaged in the collection and processing for subsequent intelligence purposes of foreign, noncommunications, electromagnetic radiations emanating from other than nuclear detonations or radioactive sources.

Electronic intelligence parameter limit list (EPL) - A compilation of identified signals with assigned ELINT notations.

Electronic jammers –

1. **Expendable** - A transmitter designed for special use such as being dropped behind enemy lines.

2. **Repeater** - A receiver-transmitter device that, when triggered by enemy radar impulses, returns synchronized false signals to the enemy equipment. The returned impulses are spaced and timed to produce false echoes or bearing errors in the enemy equipment. See Expendable and Repeater Jammers.

Electronic jamming - The deliberate radiation, reradiation, or reflection of electromagnetic energy with the object of impairing the use of electronic devices, equipment, or systems.

Electronic order of battle - A listing of all the electronic radiating equipment of a military force giving location, type function, and other pertinent data.

Electronic reconnaissance - Specific reconnaissance directed toward the collection of electromagnetic radiations. Examples:

COMINT	Communications Intelligence
ELINT	Electronic Intelligence
OPINT	Optical Intelligence
RINT	Radiated Intelligence
SIGINT	Signal Intelligence

Electronic warfare (EW) - Military action involving the use of electromagnetic energy and directed energy to control the electromagnetic spectrum. EW has three divisions: electronic attack (EA), electronic protection (EP), and electronic warfare support (ES).

Electronic warfare support (ES) - Actions taken to search for, intercept, identify, and locate sources of intentional radiated electromagnetic energy for the purpose of immediate threat recognition. Surveillance of the electromagnetic spectrum that directly supports an operational commander's electromagnetic information needs. ES is a division of EW.

Electro-optics (EO) - The interaction between optics and electronics leading to the transformation of electrical energy into light, or vice versa, with the use of an optical device.

Electro-optic counter-countermeasures (EOCCM) - Actions taken to ensure the effective friendly use of the electro-optic spectrum despite the enemy's use of countermeasures in that spectrum.

Emission control (EMCON) –

1. The management of electromagnetic radiations to counter an enemy's capability to detect, identify, or locate friendly emitters for exploitation by hostile action.

2. Controlling the radiation of an active system to minimize detection by enemy sensors.

Endgame - The period of military engagement 3-5 seconds before missile impact.

Endgame countermeasures (EGCM) - Actions taken to defeat a tracking missile. This includes expendables, decoys, and maneuvers.

Essential elements of information (EEI) - The critical items of information regarding the enemy and his environment needed by the commander by a particular time to relate with other available information and intelligence to be able to reach a logical decision.

Expendable jammer - A nonrecoverable jammer. Early expendables were limited to chaff and flare deployments; however, various radiating jamming systems exist that use noise or repeater techniques. These are dispensed by aircraft or other delivery systems and are designed to disrupt or deceive a victim radar for a short period of time.

Extremely high frequency (EHF) - Frequencies in the range of 30 to 300 GHz.

False target - Radiated bundle of electromagnetic energy that is displaced in time from the echo that creates a response in the receiver where no reflecting surface exists.

False target generator - Device for generating electromagnetic energy of the correct frequency of the receiver that is displaced in time from the reflected energy of the target.

Fast automatic gain control (FAGC) - An AGC scheme characterized by a response time that is long with respect to a PW and short with respect to the target. An ultra fast FAGC will reduce the CW capture effect on the Dicke fix.

Fast time constant circuit (in radar) –

1. A circuit with short time constant used to emphasize signals of short duration to produce discrimination against extended clutter, long-pulse jamming, or noise.

2. A resistance-capacitance differentiating network with a time constant about equal to the transmitted pulse width and employed in the video portion of the receiver to provide the discrimination against jamming with low modulating frequencies. FTC is effective against CW, long jamming pulses, swept jamming, and clutter. It is also fairly effective against chaff corridors. Based on time, the radar receiver will allow only pulses equal to its own pulse width to pass and be presented on the indicators as targets. Because of this, only the leading edges of long pulses will be displayed.

Fence –

1. Line or network of early warning radars.

2. Concentric steel fence erected around a ground radar transmitting antenna to serve as an artificial horizon and suppress ground clutter that would otherwise drown out weak signals returning at a low angle from the target.

Ferret - An aircraft, ship, or vehicle especially equipped for the detection, location, recording, and analyzing of electromagnetic radiations.

Field of view (FOV) - The maximum solid angle visible by an optical or electro-optic system.

Fire control radar - Specialized radar systems used to locate and track airborne and surface targets, compute an optimum weapons firing point, and control the firing and sometimes guidance of its weapons.

FM-by-noise modulation - A method of frequency modulating with effective jamming method against AM and fix-tuned FM receivers. Not very effective against continuously tunable PFM receivers; careful tuning can defeat a great portion of the jamming signal. For this reason, FM-by-noise is not considered optimum as a type of modulation for jamming FM receivers.

FM jamming - Technique consisting of a constant amplitude RF signal that is varied in frequency around a center frequency to produce a signal over a band of frequencies.

Forward edge of the battle area (FEBA) - The foremost limits of a series of areas in which ground combat units are deployed, excluding the areas in which the covering or screening forces are operating, designated to coordinate fire support, the positioning of forces, or the maneuver of units.

Frequency agility - A radar's ability to change frequency within its operating band, usually on a pulse-to-pulse basis. This is an EP technique employed to avoid spot jamming and to force the jammer to go into a less effective barrage mode.

Frequency band designations –

1. As decided upon by the Atlantic City Radio Convention of 1947, and later modified by Comite Consultatif International Radio (CCIR) Recommendation No. 142 in 1953:

<u>Band</u>	<u>RF Range</u>	<u>Band</u>	<u>RF Range</u>
VLF	0-30 kHz	VHF	30-300 MHz
LF	30-300 kHz	UHF	300-3000 MHz
MF	300-3000 kHz	SHF	3-30 GHz
HF	3-30 MHz	EHF	30-300 GHz

2. Electronic warfare uses the following designations:

A	0-250 MHz	H	6-8 GHz
B	250-500 MHz	I	8-10 GHz
C	500-1000 MHz	J	10-20 GHz
D	1000-2000 MHz	K	20-40 GHz
E	2-3 GHz	L	40-60 GHz
F	3-4 GHz	M	60-100 GHz
G	4-6 GHz		

Frequency bandpass - The number of hertz where maximum output is obtained between two limits usually defined and bounded by lower and upper half power (3 dB) points.

Frequency hopping - An anti-jamming technique used by a radar system. The carrier frequency of the pulsed transmissions are periodically or continuously shifted within limits on each successive pulse.

Frequency diversity - Method of transmission and/or reception using several frequencies simultaneously to minimize the effects of selective fading, deliberate jamming, or interference.

Frequency modulated CW (FM-CW) jamming - FM of a CW signal to produce a wide band of signals when the exact operating frequency of the victim is not known within the CW limits.

Frequency modulation (FM) - A method of impressing a message upon a carrier signal by causing the carrier frequency to vary proportionally to the message waveform.

Frequency shift keying (FSK) - A form of FM where the carrier is mined code. In multiple FSK, the carrier is shifted to more than two frequencies. FSK is used principally with teletype communications.

Frequency spectrum - The entire range of frequencies of electromagnetic radiation.

G - Acceleration due to gravity (32.2 ft/sec²).

Gain (manual) - The receiver gain control allows the operator to vary the receiver sensitivity. It is not designed as an AJ feature; however, when properly employed it may greatly reduce the effects of jamming. The radar detection capability is also reduced by an equal amount.

Gain (transmission gain) - The increase in signal power in transmission from one point to another under static conditions. Note: Power gain is usually expressed in decibels.

Glint (in radar) –

1. The random component of target location error caused by variations in the phase front of the target signal (as contrasted with scintillation error). GLINT may affect angle, range of Doppler measurements, and may have peak values corresponding to locations beyond the true target extent in the measured coordinate.

2. Electronic countermeasures that use the scintillating, or flashing, effect of shuttered or rotating reflectors to degrade tracking or seeking functions of an enemy weapons system.

Ground controlled intercept (GCI) - Vectoring an interceptor aircraft to an airborne target by means of information relayed from a ground-based radar site that observes both the interceptor and target.

Guidance system (missile) - A system that evaluates flight information, correlates it with target data, determines the desired flight path of the missile, and communicates the necessary commands to the missile flight control system.

Guided missile - An unmanned vehicle moving above the surface of the earth, whose trajectory of flight path is capable of being altered by an external or internal mechanism.

Height finder - A radar used to detect the angular elevation, slant range and height of objects in the vertical sight plane. An air defense ground radar used specifically to accurately determine aircraft altitude for tracking and ground controlled intercepts.

Hertz (Hz) - The unit of frequency, equal to one cycle of variation per second. It supersedes the unit cycle per second (cps).

High frequency (HF) - Frequencies from 3000 - 30,000 kHz.

Home-on-jam (HOJ) - A missile mode of operation in which a jamming signal is used to develop steering information for the missile to home in on the jamming source.

Homing guidance - A system by which a missile steers itself toward a target by means of a self-contained mechanism which is activated by some distinguishing characteristics of the target.

Identification, friend or foe (IFF) - A system using radar transmission to which equipment carried by friendly forces automatically responds, for example, by emitting pulses, thereby distinguishing themselves from enemy forces. It is the primary method of determining the friendly or unfriendly character of aircraft and ships by other aircraft and ships, and by ground forces employing radar detection equipment and associated identification, friend or foe units.

Image frequency - An undesired input frequency capable of producing the selected frequency by the same process. NOTE: An image frequency is a frequency which differs from, but has a certain symmetrical relationship to, that which a superheterodyne receiver is tuned. Consequently, the image frequency can be mistakenly accepted and processed as a true frequency by the receiver.

Image jamming - Jamming at the image frequency of the radar receiver. Barrage jamming is made most effective by generating energy at both the normal operating and imaging frequency of the radar. Image jamming inverts the phase of the response and is thereby useful as an eagle deception technique. Not effective if the radar uses image rejection.

Imitative deception - The introduction of radiations into enemy channels which imitates their own emissions.

Imitative jamming - The jamming technique of transmitting a signal identical to the original guidance signal.

Infrared (IR) - That portion of the frequency spectrum lying between the upper end of the millimeter wave region and the lower (red) end of the visible spectrum. In wavelength, the IR lies between 0.78 and 300 microns; in frequency, it lies between one and 400 terahertz (THz).

Infrared counter-countermeasures (IRCCM) - Actions taken to effectively employ our own infrared radiation equipment and systems in spite of the enemy's actions to counter their use.

Infrared countermeasures (IRCM) –

1. Countermeasures used specifically against enemy threats operating in the infrared spectrum.
2. Actions taken to prevent or reduce the effectiveness of enemy equipment and tactics employing infrared radiation.

Instantaneous automatic gain control (IAGC) –

1. That portion of a system that automatically adjusts the gain of an amplifier with varying input pulse amplitudes. The adjustment is sufficiently fast to operate while a pulse is passing through the amplifier.
2. In radar, a quick-acting automatic gain control that responds to variations of mean clutter level, or jamming over different range or angular regions, avoiding receiver saturation (also known as back-bias). IAGC automatically adjusts the gain of the radar receiver so that strong signals do not block adjoining weak signals. IGAC is not quick enough to block short pulse jamming, extended clutter, or chaff.

Instantaneous frequency CFAR (IFCFAR) - A technique similar to the IF DICKE FIX CFAR, except for having a phase detector instead of a frequency discriminator. The primary use of this technique, combined with rapid random frequency changes, is to make chaff signals appear noise-like so they can be handled conventionally.

Instantaneous inverse gain - Pulse-by-pulse amplification, modulation, and reradiation of the victim's radar pulse to obscure angle data.

Intercept point - A computed point in space toward which an interceptor is vectored to complete an interception.

Interference (electronic) - An electrical or electromagnetic disturbance that causes undesirable responses on electronic equipment. Electrical interference refers specifically to interference caused by the operation of electrical apparatus that is not designed to radiate electromagnetic energy.

Interferometer - As pertains to radar, a receiving system which determines the angle of arrival of a wave by phase comparison of the signals received at separate antennas or separate points on the same antenna.

Interleaved jamming - Time sharing of a jammer's output around many threats usually to cover pulse jamming.

Intermediate frequency (IF) –

1. A fixed frequency to which all carrier waves are converted in a superheterodyne receiver.

2. A frequency to which a signaling wave is shifted locally as an intermediate step during transmission or reception.

3. A frequency resulting from the combination of the received signal and that of the local oscillator in a superheterodyne receiver.

Intermediate frequency jamming - Form of CW jamming that is accomplished by transmitting two CW signals separated by a frequency equal to the center frequency of the radar receiver IF amplifier.

Interrogator - A device used to transmit pulse-coded challenges to an IFF transponder and then evaluates the pulse-coded reply for identification purposes.

Intrapulse modulation repeater - A classified deception jamming technique.

Intrusion –

1. The entry of a nonfriendly aircraft or system into friendly air space.

2. The intentional interference in a communication system by which the intruder attempts to confuse, delay, or cause error by the selective introduction of additional data.

Inverse conscan - One method of confusing a radar operator or fire control radar system is to provide erroneous target bearings. This is accomplished by first sensing the radar antenna scan rate and then modulating repeater amplifier gain so that the weapons systems will fire at some bearing other than the true target bearing. The angle deception technique is used to break lock on CONSCAN radars.

Inverse gain - Amplification, inverse modulation, and reradiation of a radar's pulse train at the rotation rate of the radar scan. Deceives a conical scanning radar in angle.

Inverse-gain repeater jammer - A form of repeater in which the jammer creates false targets by varying the output power inverse with the strength of the received radar signal.

Jaff - Expression for the combination of electronic and chaff jamming. An ECM tactic involving the use of jammers to illuminate chaff corridors or chaff bursts to produce false targets.

Jam attenuator control - Used to prevent receiver saturation from any strong signals, including electronic jamming, chaff, or clutter. It also permits the determination of the bearing and elevation of jammers that would cause wide sectors of the scope to be obscured. The control reduces all signals equally, jamming as well as targets. This control should be used in the jammed sector only and not for an entire antenna revolution. Targets in the jammed sector would only be seen if they were stronger than the jamming. However, the jammed sector may be reduced enough in size to allow the operator to determine either bearing or elevation.

Jammer - A device used to deprive, limit, or degrade the use of communications or radar systems. Radio frequency jammers include noise, discrete frequency repeater, and deceptive equipment.

Jamming-to-signal (J/S) ratio - The relative power ratio of jamming to the radar return signal at the radar antenna. The inverse of the signal-to-jamming ratio.

Jam strobe - Also called JAVA (jamming amplitude versus azimuth). A circuit that generates a marker on the PPI to indicate signal strength as a function of bearing. It does this by sampling the jamming intensity once each repetition period. Besides showing the direction of the jammer, it also indicates the severity of main beam and sidelobe jamming.

Jet engine modulation (JEM) - Modulation present in the radar returns received from a jet aircraft, caused by the rotation of the fan or turbine blades of the aircraft's engines.

Jittered pulse repetition frequency (jittered PRF) - The PRF is rapidly varied at a random rate so that false targets appear to jitter or appear fuzzy on the scope. An alternative to jittered PRF is to change the PRF momentarily. This causes the false targets to change their position on the scope. It provides a discrimination against repeater-type jammers.

Klystron - A very stable microwave amplifier that provides high gain at good efficiency. This is accomplished by velocity modulating (accelerating a beam of electrons flowing from its cathode to its anode).

Laser target designation - The use of a laser to direct a light beam onto the target so that appropriate sensors can track or home on the reflected energy.

Leading-edge tracker - A tracking radar that obtains its data from the leading edge of the echo pulse from the target.

Light amplification by stimulated emission of radiation (LASER) - A process of generating coherent light. The process uses a natural molecular (and atomic) phenomenon whereby molecules absorb incident electromagnetic energy at specific frequencies. It then stores this energy for short but usable periods, then releases the stored energy as light at particular frequencies, and in an extremely narrow frequency band.

Lobe - One of the three-dimensional sections of the radiation pattern of a directional antenna bounded by 1-2 cones of nulls.

Lobe-on-receive-only (LORO) - Mode of operation consisting of transmitting on one antenna system and receiving the reflected energy on another system (TWS, conical, or monopulse).

Local oscillator off - A simple expedient of shutting off the local oscillator during barrage jamming. The barrage jammer will not be seen unless there is a beating signal such as a target; therefore, targets will appear. Since targets will not

appear in directions where no jamming arises, either an automatic azimuth switch or an additional receiver display is required.

Logarithmic fast time constant log (LOG-FTCL) - A device consisting of a logarithmic IF amplifier followed by an FTC circuit. The LOG-FTC combination is very effective in removing variations in the video output noise level caused by spot noise, wideband noise, and slow sweep noise modulated AM jamming.

Logarithmic receiver - A receiver whose response approximates the logarithm of the strength of the incoming signal. A special type of receiver having a large dynamic range of automatic gain control that gives considerable protection against receiver saturation by strong jamming on interference signals. Useful against weather, clutter, chaff, and spot jamming.

Look-down, shoot-down - Refers to an air interceptor (AI) equipped with a pulse Doppler radar, or a radar that has a moving target indicator (MTI) feature, that can detect and lock-on to a target within ground return clutter enabling the AI to track and shoot the target.

Look-through –

1. When jamming, a technique by which the jamming emission is interrupted irregularly for extremely short periods to allow monitoring of the victim signal during jamming operations.

2. When being jammed, the technique of observing or monitoring a desired signal during interruptions in the jamming signals.

Low frequency (LF) - Frequencies from 30 - 300 kHz.

Low power spread spectrum radar - A low power, high duty cycle radar whose spectrum is spread 100 MHz or more. Since this radar has a broad output spectrum and a high duty cycle, neither time nor frequency can be effectively used to resolve these signals. This leaves direction as the prime method of resolution. The spectrum of these radars is spread over the bandwidth by any of the pseudo random noise modulating techniques commonly used in communications. Techniques such as bi-phase modulation, quaternary phase modulation, chirp, random frequency jumping, etc., may be used to spread either a CW signal or a very high duty cycle signal. Such signals have a very good range resolution—approximately equal to the reciprocal of the bandwidth.

Magnetron - A radar microwave device whose operation is based on the motion of electrons (AC) under the influence of combined electric and magnetic fields.

Mainlobe - The lobe of a transmitting or receiving antenna centered on the directivity axis of the antenna.

Manipulative deception - The alteration or simulation of friendly electromagnetic radiations to accomplish the deception.

Meaconing, interference, jamming, and intrusion (MIJI) - An acronym of four component parts to determine the intent and technique of electromagnetic radiation.

Meaconing - a system of receiving radio beacon signals and rebroadcasting them on the same frequency to confuse navigation. **Interference** - unintentional electromagnetic radiation that may cause interference with electronic equipment.

Jamming - the deliberate radiation, reradiation, or reflection of electromagnetic energy with the intent of impairing the use of electronic devices, equipment, or systems being used by the enemy.

Intrusion - the intentional insertion of electromagnetic energy into transmission paths in any manner with the objective of deceiving operators or causing confusion.

Medium frequency (MF) - Frequencies from 300 to 3,000 kHz.

Micron - A unit of length equal to a micrometer (10^{-6} meters).

Microwave amplification by stimulated emission or radiation (MASER) - A low-noise, radio-frequency amplifier. The emission of energy stored in a molecular or atomic system by a microwave power supply is stimulated by the input signal.

Microwave communications - Line-of-sight communications, the frequency of which is higher than 300 MHz.

Millimeter waves - Frequencies (30 GHz to 300 GHz) in the millimeter portion of the electromagnetic spectrum.

Miss distance - The distance measured between the closest paths of a target and interceptor (i.e., aircraft and missile). One objective of self-protection jamming systems is to increase the miss distance to avoid destruction if missile launch cannot be prevented.

Missile approach warning system (MAWS) - A system used to detect and provide warning of approaching missiles. MAWS may be partitioned into active MAWS and passive MAWS.

1. **Active missile approach warning system (AMAWS)** - Generally employs pulse Doppler radar as its sensor. This radar is able to discern a moving target in stationary or slow-moving background clutter.

2. **Passive missile approach warning system (PMAWS)** - An ultraviolet (UV) or infrared-based detector system with the ability to detect and distinguish threat missiles from surrounding clutter and non-lethal missiles.

Modulated barrage jamming - A technique that varies the amplitude of the output power of a barrage jammer with sinusoidal or complex modulation.

Modulated CW jamming - A CW carrier waveform that has been modulated with another signal (such as noise, low, medium, or high frequencies), and is transmitted for the purpose of deception. May be AM, FM, pulse modulated (PM), etc.

Modulated PRF (MPRF) - The deliberate modulation of the interpulse spacing in a pulse train. See PRF Jitter and PRF Stagger.

Modulation - The variation of amplitude, frequency, or phase of an electromagnetic wave by impressing another wave on it.

Modulator - A device (such as an electron tube) for modulating a carrier wave or signal for the transmission of intelligence of some sort.

Monopinch - Anti-jam application of the monopulse technique where the error signal is used to provide discrimination against jamming signals.

Monopulse - A method of pulse generation that allows the simultaneous determining of azimuth, elevation and range, and/or speed from a single pulse.

Monopulse radar - A radar using a receiving antenna system having two or more partially overlapping lobes in the radiation patterns. Sum and difference channels in the receiver compare the amplitudes or the phases of the antenna outputs to determine the angle of arrival of the received signal relative to the antenna boresight. A well-designed monopulse tracking system will achieve a more accurate track under conventional jamming techniques than on the skin return. Certain monopulse trackers are susceptible to angular jamming techniques such as skirt and image jamming. Techniques such as "CROSS EYE" are designed to

attack all monopulse tracking systems. Monopulse deception is a major area of advanced R&D with no clear “best technique” yet in sight.

Moving target indicator (MTI) - A radar presentation that shows only targets that are in motion. Signals from stationary targets are subtracted out of the return signal by the output of a suitable memory circuit.

MTI CFAR - A technique that provides CFAR capability in an MTI receiver. The cancellation of ground clutter is not impaired during radar jamming.

Multiband radar - Radar that simultaneously operates on more than one frequency band through a common antenna. This technique allows for many sophisticated forms of video processing and requires that a jammer must jam all channels simultaneously.

Multiplex - Simultaneous transmission of two or more signals on a common carrier wave. The three types of multiplex are called time division, frequency division, and phase division.

Multitarget generator jamming - A technique where a generator takes the radar's PRF, scan rate, and antenna lobe pattern and computes when to transmit false targets at the radar's frequency. The targets appear as true targets, but normally only about 20 percent of the targets are programmed to give a logical course and speed. The many targets saturate the tracking operator's capability by the sudden appearance of multiple targets, and/or many targets either stationary or on illogical courses and speeds, or maneuvers such as 90 degree turns at high speeds but with no displacement. Also, targets may appear in back and sidelobe positions.

Music - In air intercept, a term meaning electronic jamming.

Narrowband (NB-1) - Narrows the receiver frequency making it more selective. It limits the target signals and the jamming signal to a set level of amplitude and reduces the level of a jamming signal if the jammer is not tuned to the radar's exact frequency.

Narrow pulse jamming - Jamming where the jammer pulse width is less than the radar's pulse width. Technique may be required by interleaved jamming.

Noise –

1. Any unwanted disturbance within a dynamic electrical or mechanical system, such as undesired electromagnetic radiation, and any transmission channel or device.

2. Uncontrolled random disturbances that arise in a guided missile system because of various physical phenomena.

Noise jamming - Direct (straight) AM or FM noise on a carrier frequency that has a highly variable bandwidth for the purpose of increasing (saturating) the radar receiver's noise level.

Nuclear effects - The electromagnetic phenomena resulting from a nuclear explosion. The phenomena are listed as follows:

1. **Argus phenomena (trapped electrons)**. The trapping in the earth's magnetic field of electrons produced by a nuclear burst.

2. **Blackout (radio frequency interference)**. An effect that is the result of ionization produced by a nuclear explosion in or above the atmosphere. This ionization can cause interference (blackout) by attenuating, reflecting, cluttering, and scattering radar electromagnetic pulses in a high-intensity burst of electromagnetic radiation, predominantly in the radio frequency range of the spectrum.

3. **Optical phenomena**. Intense radiations covering all parts of the optical spectrum are produced by the interactions between the atmosphere and the nuclear radiation and fission products resulting from a nuclear detonation. The resulting auroras and airglows are created as an optical background that can affect reconnaissance, tracking, warning and homing systems, and personnel.

4. **Transient radiation effects on electronics**. Nuclear radiation impinging on electronic systems or components can substantially alter the operation and output of these systems. The word transient refers to the type of environment and not to the duration of the effect since the effect may be either transient or permanent.

Nulls - Points of no radiation in an antenna radiation pattern.

Obscuration - Effects produced by masking-type jammers. Denial of either range or angle is achieved by submerging data interference caused by noise or noise-like signals.

Off-frequency spot jamming - A type of spot jamming in which the jammer frequency is off the radar operating frequency but still within the radar receiver bandpass.

Optical countermeasures - Applications of electronic countermeasures in the visible light portion of the electromagnetic spectrum. Actions taken to prevent or reduce an enemy's effective use of the visible spectrum.

Oscillator - Electronic circuit or device capable of converting direct current (DC) into alternating current (AC) at a frequency determined by the inductive and the capacitive constants of the oscillator.

Over-the-horizon radar - A radar system that makes use of the ionosphere to extend its range of detection beyond line-of-sight. Over-the-horizon radars may be either forward scatter or backscatter systems.

Palmer scan - Conical scan superimposed on another type of scan pattern-usually a spiral pattern.

Passive angle tracking (PAT) - A target may be tracked "passively" if that target emits electromagnetic radiation; i.e., jamming radio, radar signal of sufficient duration that a DF bearing may be obtained. The emission from the target is DF-ed in azimuth and/or elevation. No range information will be available unless cross DF techniques are used by two or more passively tracking sites.

Passive detection and tracking - By combining azimuth data on jamming strobes from several stations, intersections are obtained which indicate the position of the jammers. The number of ghosts can be reduced by increasing the number of friendly stations and obtaining elevation angles of strobes when available.

Passive electronic countermeasures - Electronic countermeasures based on the reflection, absorption or modification of the enemy's electromagnetic energy. This distinction between active and passive countermeasures is not currently used, but is based on the presence or absence of an electronic transmitter.

Passive homing guidance - A system of homing guidance in which the receiver in the missile uses radiations only from the target.

Peak power - Maximum power output during transmission time. Expressed in watts or megawatts.

Penetration aids - Techniques and/or devices employed by aerospace systems to increase the probability of weapon system penetration of any enemy defense.

Examples are: Low altitude profiles, trajectory adjustments, reduced radar cross-sections of attack vehicles, improved vehicle hardness to effects of defense engagements, terrain avoidance radar, bomber defense missiles, decoys, chaff, electronic countermeasures, etc. Penetration aids are used by an offensive system to penetrate enemy defenses more effectively. Also called PENAIDS.

Phase modulation - A method of impressing a message upon a carrier signal by causing the carrier phase to vary proportionally to the waveform.

Phase shift keying - A method of impressing a digital signal upon a carrier signal by causing the carrier phase to take different values corresponding to the different values of the digital signal.

Phased array radar - Radar using many antenna elements that are fed out-of-phase to each other. The direction of the beam can be changed as rapidly as the phase relationships (usually less than 20 μ sec). Thus, the antenna remains stationary while the beam is moved electronically. The use of many antenna elements allows for very rapid and high directivity of the beam(s) with a large peak and/or average power.

Point defense - The defense of specified geographical areas, cities, and vital installations. One distinguishing feature of point defense missiles is that their guidance information is received from radars located near the launching sites.

Polarization - The direction of an electrical field is considered the direction of polarization. When a half-wave dipole antenna is horizontally oriented, the emitted wave is horizontally polarized. A vertical polarized wave is emitted when the antenna is erected vertically.

Polarization diversity - The variation of polarization (such as horizontal, vertical, circular, or elliptical for radar use) either simultaneously or singularly.

Power management - Generally classified methods to optimize all related EW activities and facilities-usually in reference to a coordinate, optimized EW suite.

PPI scope - A radar display yielding range and azimuth information via an intensity modulated display and a circular sweep of a radial line. The radar is located at the center of the display.

PRF jitter - PRF rapidly varied at a random rate so that false targets appear to jitter, or appear fuzzy, on the scope. An alternative to jittered PRF is to momentarily change the PRF. This causes the false targets to change their position on the scope.

PRF stagger - The technique of switching PRF or PRI to different values on a pulse-to-pulse basis such that the various intervals follow a regular pattern. This is useful in compensating for “blind speeds” in pulsed MTI radars. Interpulse intervals differ but follow a regular pattern.

Pseudo noise - A modulation technique resulting in low signal selectability and decreased vulnerability to jamming.

Pulse compression - A scheme whereby a specifically modulated, medium power long pulse is stretched and transmitted. The returned pulse is compressed in the receiver demodulation process to obtain the advantage of narrow pulse operation. Long pulses provide the advantage of long range detection and short (compressed) pulses provide the advantage of better resolution and accuracy. This technique uses matched filter techniques for discriminating against signals that do not correspond to the transmitted code. It permits an increase in average transmitted power (without an increase in peak power) with no loss in range resolution. Pulse compression is a special form of pulse coding and correlation.

Pulse deception jamming - Any of the many false target techniques used to deceive a pulse radar, as opposed to obscurative noise techniques.

Pulse discriminator - Device that responds only to a pulse that has a particular characteristic, such as duration or period.

Pulse Doppler radar - A highly complex radar system that employs a very high pulse repetition frequency (usually 10,000 PPS or higher) to reduce “blind speeds” and measure the Doppler frequency shift to resolve target velocity. Pulse Doppler is applied principally to radar systems requiring the detection of moving targets in a ground clutter environment. It uses pulse modulation to achieve higher peak power, greater range, less susceptibility to unfriendly detection, and enhanced range resolution.

Pulse duration - The time in microseconds that the radar set is transmitting RF energy. Generally, the greater the pulse duration, the higher the average power, but the poorer the range resolution. Also known as pulse width. More technically, it is the time interval, measured at the half-amplitude points, from the leading edge to the trailing edge of a pulse.

Pulse group - In complex pulse trains, two or more pulses that are recognizably distinct from the others.

Pulse interference suppression and blanking (PISAB) - An EP automatic interference blanking device that will blank all video signals not synchronous

with the radar PRF. PISAB does not require any trigger and operates on both normal and MTI modes. It is effective against random pulse signals.

Pulse jitter - Random variation of interpulse interval.

Pulse modulation (PM) - A special case of amplitude modulation in which the carrier wave is varied at a pulsed rate. This series of pulses is generally for transmitting data. The result is a short, powerful burst of electromagnetic radiation that can be used for measuring the distance from a radar set to a target.

Pulse modulated jamming - Use of jamming pulses of various widths and repetition rates.

Pulse position modulation - Modulation by variation of the interval that elapses between the pulse to be modulated in a group of pulses and a synchronizing pulse, usually the first pulse of the group.

Pulse repetition frequency (PRF) - The rate at which pulses or pulse groups are transmitted from a radar set. Generally, PRF is the number of pulses generated per second and is expressed in hertz (Hz).

Pulse repetition interval (PRI) - The interval of time between two transmitted radar pulses, usually expressed in microseconds. PRI is the inverse of PRF.

Pulse recurrence time (PRT) - Time elapsing between the start of one transmitted pulse and the start of the next. It is the reciprocal of PRF.

Pulse recurrence time (PRT) agility - Ability of the radar set to vary the number of pulses per set.

Pulse width (PW) - See Pulse Duration.

Pulse width discrimination (PWD) - An EP technique used to discriminate against received pulses that do not have the same duration as the radar transmitted pulse. PWD is used in eliminating the effects of pulse type interference when the interference pulses are not the same length as the real radar pulse. Since this circuit generates a blanking gate that shuts off the receiver whenever a pulse of improper length is sensed, loss of valid target data can result. PWD offers good discrimination against long-pulse jamming and jamming signals employing low frequency noise modulation. It affords little or no discrimination against short pulses and HF noise modulations.

Pulse width discriminator - A device that measures the pulse length of video signals and passes only those pulses whose time duration falls into some predetermined design tolerances. A pulse width discriminator will generally provide some gain against barrage jamming, similar to that of a matched filter in the video.

“Rabbits” - Interference from another radar on or near the frequency of the receiving radar. Shows on the indicators as interference at the rate of the relative PRF of the interfering radar.

Radar - From Radio Detection And Ranging. A device used to detect a distant target and determine and display its relative direction (azimuth) and its relative distance (range).

Radar absorbent material (RAM) - Material used as a radar camouflage device to reduce the echo area of an object.

Radar beacon - A receiver-transmitter combination that sends out a coded signal when triggered by the proper type of pulse enabling determination of range and bearing information by the interrogating station or aircraft.

Radar cross section - The equivalent area intercepted by a radiated signal and, if scattered uniformly in all directions, produces an echo at the radar receiver equal to that of the target. Typical radar cross sections of aircraft vary from one to over 1,000 square meters. The RCS of ships may exceed 10,000 square meters.

Radar definition - The accuracy with which a radar obtains target information such as range, azimuth, or elevation.

Radar homing - Homing on the source of a radar beam.

Radar homing and warning (RHAW) - Typically consists of an airborne, wideband video receiver designed to intercept, identify, and display the direction to pulse-type emitters.

Radar resolution - A measure of a radar's ability to separate targets that are close together in some aspect of range, azimuth, or elevation into individual returns.

Radar warning receiver (RWR) - A receiver onboard an aircraft that analyzes the hostile radar environment and determines radar threat by type, frequency, relative bearing, and relative distance. The threat is displayed to the aircrew by means of display lights, video symbols, and aural tones.

Radio frequency (RF) - Electromagnetic energy radiated at some frequency.

Radio frequency interference - An unintentional interfering signal capable of being propagated into electronic equipment, usually derived from sources outside the system.

Railing –

1. Pertains to radar pulse jamming at high recurrence rates (50 to 150 kHz). It results in an image on a radar indicator resembling fence railing.

2. The name given to that pattern produced on an “A” scope by CW modulated with a high frequency signal. Railings appear as a series of vertical lines resembling target echoes along the baseline.

Random modulation CW jamming - The use of a nonperiodic function to an AM, FM, or AM/FM CW carrier. The effects produced on a radar are similar to those produced by DINA.

Random noise - Electromagnetic energy having no particular modulation or pattern. May be generated by either natural atmospheric phenomena or by electromagnetic radiation devices.

Random pulse jamming - The technique by which a pulse transmission system is pulsed irregularly by random noise signals.

Range - The distance from one object to another.

Range gate - A gate voltage used to select radar echoes from a very short range interval.

Range gate capture - A jamming technique using a spoofer radar transmitter to produce a false target echo that can make a target tracking radar move off the real target and follow the false one.

Range gate pull-in (RGPI) - Same as range gate pull-off (see next text entry) except that the deceptive pulse is transmitted before the radar pulse is received. This is accomplished by digital storage of the pulse repetition period which must be extremely stable.

Range gate pull-off (RGPO) - A deception technique used against pulse tracking radars using range gates. The jammer initially repeats the skin echo with minimum time delay at a high power to capture the AGC circuitry. The delay is

progressively increased, forcing the tracking gates to be pulled away (“walked off”) from the target echo. Frequency memory loops (FML) or transponders provide the variable delay.

Range gate tracker - A radar system that tracks targets in range by measuring the elapsed time from the transmitted pulse to the echo return.

Range tracking - Pulse radars measure the time difference between radar pulse transmission and echo reception. The range gate is positioned at a range where the target is expected. The receiver is blanked off except during the period where the range gate is positioned. Range tracking may occur at the leading edge of the return pulse or between ON and OFF gates.

Recovery time (RT) - The time that a radar requires to “get ready” to receive after a pulse is sent out. Time is required to get ready because the high-powered pulse tends to fill the sensitive radar receiver with RF energy, which prevents target returns from being seen. A short “damping out” period occurs after the pulse width during which time the RF energy dissipates, allowing weak target echoes to once again be detected.

Rectifier - A device (such as a vacuum tube) for converting alternating current (AC) into direct current (DC).

Repeater - A receiver-transmitter combination that amplifies the received signal and retransmits it.

Repeater jammer - Equipment used to confuse or deceive the enemy by causing his equipment to present false information. This is done by a system that intercepts and reradiates a signal on the frequency of the enemy equipment. The reradiated signal is modified to present erroneous data on azimuth, range, number of targets, etc.

Repeater jamming - Interception and reradiation of a signal with the reradiation of a signal being modified to give erroneous azimuth, range, velocity, acceleration, or number of targets.

Resolution - The ability of a system to distinguish between two adjacent objects and to display them separately.

Resolution cell - The minimum volume in space in which a radar can discriminate between targets. It is determined numerically-for a conventional radar-by the width of the beam in angle, the pulse width in range, and the velocity gate width in speed.

Response noise jammer - A repeater jammer that transmits spot noise over the received radar frequency even in the case of radar frequency agility.

Ringling - The undesired oscillation or triggering of an electrical device by its own transmitter.

Rope - An element of chaff consisting of a long roll of metallic foil or wire that is designed for broad low frequency response. (See Chaff.)

Rope chaff - Chaff that contains one or more rope elements. (See Chaff.)

Rotating polarization - The result of a rotating feed. This should not be confused with circular polarization where the electric field rotates about the axis of propagation at the radar frequency.

SAM - Surface-to-air missile.

Saturating signal - In radar, a signal of an amplitude greater than the dynamic range of the receiving system.

Sawtooth modulated jamming - Electronic countermeasure technique when a high-level jamming signal is transmitted, thus causing large AGC voltages to be developed at the radar receiver that, in turn, causes the target return and receiver noise to completely disappear.

Scan - The process of directing a beam of RF energy successively over a given region, or the corresponding process in reception.

Scan interval - The time interval from the peak of one mainlobe in a scan pattern to the peak of the next mainlobe.

Scan period - The time period of basic scan types (except conical and lobe switching) or the period of the lowest repetitive cycle of complex scan combinations. The basic unit of measurement is degrees/mils per second or seconds per cycle.

Scan rate modulation - Modulation of the deception jamming signal with one or more frequencies that are related to the scan rate of the radar.

Scan type - The path made in space by a point on the radar beam, for example, circular, helical, conical, spiral, or sector.

Search –

1. A term applied to that phase of radar operation when the lobe, or beam of radiated energy, is directed in such a way to search for targets in the area.
2. A systematic examination of space to locate and identify targets of interest.

Sector scan - A scan in which the antenna sweeps back and forth through a selected angle.

Selective identification feature (SIF) - A capability which, when added to the basic IFF system, provides the means to transmit, receive, and display selected coded replies.

Self-protection jamming - Jamming to protect the vehicle upon which the jammer is deployed.

Semiactive radar homing - Semiactive homing guidance combines principles from both the beam rider and the active radar homing missile. Track on the target is established by the AI's radar; the missile is launched when the target comes within its effective range. During missile flight, the AI maintains track on the target. Radar returns from the target are received by the missile. Guidance commands are generated within the missile from the radar returns.

Sensitivity time control (STC) - Programmed variation of the gain (sensitivity) of a radar receiver as a function of time within each pulse repetition interval or observation time. STC prevents overloading of the receiver by strong echoes from targets or clutter at close ranges. STC reduces the gain of the radar receiver for detection of close-in targets. It is particularly effective in removing close-in clutter and strong nearby signals. STC also refers to a circuit that reduces the gain of the radar receiver immediately following the transmission of the radar pulse so that the receiver is not saturated by strong radar returns from nearby objects.

Serrodyne - A method of “pulling off” the velocity gate of a Doppler radar by using a voltage-controlled phase shifter, usually a traveling wave tube (TWT). This introduces a frequency shift from zero to some maximum value, pulling the Doppler tracking gate away from the skin echo. The phase shift is usually accomplished by modulating the TWT's helix voltages.

Sidelobe - Part of the beam from an antenna, other than the mainlobe. Sidelobe gain is usually less than mainlobe gain. Given that the mainlobe radiates most of the power at zero degrees azimuth, sidelobes inherently radiate significant power in the direction of +20°, 90°, and 150° relative to the mainlobe.

Sidelobe blanking (SLB) - A device that employs an auxiliary wide angle antenna and receiver to sense whether a received pulse originates in the sidelobe region of the main antenna and to gate it from the output signal if it does. This technique uses an omnidirectional antenna and compares relative signal strength between the omni and the radar antenna. The omnichannel (plus receiver) has slightly more gain than the sidelobes of the normal channel, but less gain than the main beam. Any signal that is greater in the omnichannel must have been received from a sidelobe and is blanked. This technique is effective in removing spoofed signals with a duty cycle up to 50%.

Sidelobe canceller (SLC) - A device that employs one or more auxiliary antennas and receivers to allow linear subtraction of interfering signals from the desired output if they are sensed to originate in the sidelobe of the main antenna. This technique employs the same antenna and receiver configurations of the SLB, except that a gain matching and canceling process takes place. Extraneous signals entering the sidelobes of the main antenna are canceled while the targets remain. This type of system exhibits cancellation roughly 20 dB against a single noise jammer. With multiple jammers at various azimuths, the performance of this device rapidly deteriorates.

Sidelobe jamming - Jamming through a sidelobe of the receiving antenna in an attempt to obliterate the desired signal received through the mainlobe of the receiving antenna at fixed points.

Sidelobe suppression - The suppression of that portion of the beam from a radar antenna other than the mainlobe.

Sidewinder - A solid-propellant, air-to-air missile with nonnuclear warhead and an infrared guidance system. Designated as the AIM-9 missile.

Signal intelligence (SIGINT) - Intelligence derived from the interception of enemy communications and noncommunication signals. A generic term that includes both COMINT and ELINT.

Signal-to-jamming ratio (S/J) - The ratio of the signal power to the jamming power or intentional interference at some point in the system. This ratio is often expressed in decibels.

Signal-to-noise ratio (S/N) - Ratio of the power of the signal to the power of the noise.

Signature - The set of parameters that describes the characteristics of a radar target or an RF emitter and distinguishes one emitter from another. Signature

parameters include the RF of the carrier, the modulation characteristics (typically the pulse modulation code), and the scan pattern.

Sine-wave modulated jamming - Jamming signal produced by modulating a CW signal with one or more sine waves.

Single beam blanking (SBB) - Used by phased array radars as an alternative method of Beam to Beam Correlation (BBC). It is effective, to some degree, against many multiple target generators and swept frequency jammers. Because of overlapping beamwidths, a target signal will appear in more than one beam as the beams are scanned past a true target. When jamming signals are transmitted along one beam, that beam is blanked by the radar receiver.

Skirt jamming - Jamming that places the signal somewhat off the radar center frequency but within the IF skirts. The technique will degrade the tracking accuracy of some monopulse radars; however, good radar design makes the technique ineffective.

Smart jamming - Selective jamming of threat radars with an optimized modulation signal at a correct time. Power management techniques are used to control smart jamming systems.

Smith modulation - Deceptive technique that operates on the servo loop of the victim's radar. Two RF carriers are transmitted with a few cycles difference.

Spiral scan - A pencil beam scan which moves around a central axis describing the surface of a cone in an ever-increasing cone size.

Spot jamming - Narrow frequency band jamming concentrated against radar at a particular frequency. The jamming bandwidth is comparable to the radar bandpass. Used to deny range and sometimes angle information.

Spread spectrum - Use of broader frequency bandwidths than normally required to transmit information, in order to gain advantages in interference rejection (anti-jam), message privacy/security, low probability of intercept (LPI), deny frequency resolution, multiplexing of more than one message in the same bandwidth, or high resolution range measurement.

Spurious radiation - Emissions from a radio transmitter at frequencies outside its assigned or intended emission frequency. Spurious emission includes harmonic emission, parasitic emission, and intermodulation products, but excludes emissions in the immediate vicinity of the necessary band that are a result of the modulation process for the transmission of information.

Spurious response –

1. Any response, other than the desired response, of an electric transducer or device.

2. A term used in electronic warfare to describe the undesirable signal images in the intercept receiver resulting from the mixing of the intercepted signal with harmonics of the local oscillators in the receiver.

Staggered PRF - A technique of using more than one PRF to reduce the blind speeds associated with MTI radars. PRF switching occurs on a pulse-to-pulse basis.

Stand-off jammer (SOJ) - A powerful jammer that remains at a safe range while providing jamming coverage (masking) for the attacking elements. The Navy EA-6B is an example of a SOJ aircraft.

Stand-off jamming (SOJ) - A jamming aircraft that orbits outside the maximum range of the SAM threat. As the attack package penetrates, the jamming aircraft directs jamming against all significant radars in the area.

Stream - Dispensing of chaff (solid/random interval/bursts).

Stream chaff - Operational technique of dropping large quantities of chaff for a continuous period of time. This results in a “ribbon” or “stream” of returns many miles in length on victim radar scopes. The penetrating attack package can then use the resulting chaff corridor to mask their penetration.

Super high frequency (SHF) - Frequencies from 3 to 30 GHz.

Support jamming - A tactic by which aircraft carrying electronic jamming equipment orbit at a safe distance from the enemy threat defenses or fly escort with the strike force for the primary purpose of screening them from the threat radars.

Suppression of enemy air defenses (SEAD) - That activity which neutralizes, destroys, or temporarily degrades enemy air defense systems in a specific area by using physical attack, deception, and/or electronic warfare.

Surface-to-air missile (SAM) - A missile launched from a surface launcher at a target above the surface.

Sweep jammer - Electronic jammer that sweeps a narrow band of electronic energy over a broad bandwidth.

Sweep lock-on jammer - A transmitter in which a narrowband jamming signal can be tuned over a broad frequency band and the signal locked on a particular frequency.

Swept audio - Jamming technique usually employed against conical scan-on-receive-only (COSRO) radars. The received pulses are amplified and retransmitted by the target and amplitude modulated at a frequency close to the suspected receiver antenna scan frequency.

Swept jamming - An EA technique of barrage jamming in which a CW carrier or noise source is swept over a selected bandwidth.

Swept-spot jamming - A jamming technique in which an oscillator is swept over a specific range of frequencies in the band of interest in order to be assured of exciting a receiver tuned to any frequency in that band.

Synchronized-pulse jamming - The technique of attempting to insert jamming pulses into a receiver each time the receiver gate opens.

Synchronous-pulsed jamming - A jamming technique that matches exactly the PRF of the victim's radar; then transmits multiples of the PRF. It is most effective if the jammer also matches the PW of the radar. Synchronous-pulsed jamming is easily recognized since the spacing between successive target lines is equal and each target line is the same in depth from the center outward. The width of the jammed sector is dependent upon the range of the jammer from the radar.

Synthetic aperture radar (SAR) - A high-resolution ground mapping technique in which advantage is taken of the forward motion of a coherent pulsed radar to synthesize the equivalent of a very long sidelooking array antenna from the radar returns received over a period of up to several seconds or more.

Target acquisition - The detection, identification, and location of a target in sufficient detail to permit the effective employment of weapons.

Terminal guidance –

1. The guidance applied to a guided missile between mid-course and arrival in the vicinity of the target.
2. Electronic, mechanical, visual, or other assistance given to aircraft pilots to facilitate arrival at, operation within or over, landing upon or departure from an air landing or air drop facility.

Terminal threat - The weapon systems, generally near a target, used to directly engage an aircraft in order to destroy it.

Terrain-avoidance radar - An airborne radar that provides a display of terrain ahead of low-flying aircraft to permit horizontal avoidance of obstacles.

Terrain-following radar (TFR) - An airborne radar that provides a display of terrain ahead of low-flying aircraft to permit manual control, or signals for automatic control to maintain constant altitude above the ground.

Thermal crossover - The natural phenomenon which normally occurs twice daily when temperature conditions are such that there is a loss of contrast between two adjacent objects on infrared imagery.

Threshold - The minimum value of a signal that can be detected by a system or sensor under consideration.

Time-of-arrival (TOA) - A method of locating a distant pulse emitter by measuring the difference in the time-of-arrival of its pulses at three separate locations. This method is also called Inverse LORAN.

Track –

1. A series of related contacts displayed on a plotting board.
2. To display or record the successive positions of a moving object.
3. To lock onto a point of radiation and obtain guidance from it.

4. To keep a gun properly aimed, or to continuously point a target-locating instrument at a moving target.

5. The actual path of an aircraft above, or a ship on, the surface of the earth. The course is the path that is planned; the track is the path that is taken.

Tracking - The continuous monitoring of range, velocity, or position of a target in space from a reference position. This is accomplished via radar and/or optical means.

Tracking radar - A radar that measures the range, azimuth, elevation, and/or velocity of the target and provides data that may be used by the fire control computer to determine the target path and predict its future position.

Track-on-jam - A method of passive target tracking using the jamming signal emitted by the target.

Track-while-scan (TWS) radar - Although it is not really a tracking radar in the true sense of the word, it does provide complete and accurate position information for missile guidance by using two separate beams produced by two separate antennas on two different frequencies. The system uses electronic computer techniques whereby raw data are used to track an assigned target, compute target velocity, and predict its future position while maintaining normal sector scan.

Transceiver - A combined radio transmitter and receiver in which some circuits other than those of the power supply are common to both transmitter and receiver, and not providing for simultaneous transmission and reception.

Transponder - A transmitter-receiver capable of accepting the electronic challenge of an interrogator and automatically transmitting an appropriate reply.

Traveling wave tube (TWT) - An electron tube in which a beam of electrons interacts continuously with a guided electromagnetic wave to produce amplification at microwave frequencies. A TWT capable of providing high amplification (60 dB) in frequencies over several octaves without adjustment. TWTs are classified by:

1. Power Output:

Low (less than one watt)

High (more than 10 watts)

Intermediate (one to 10 watts)

2. Noise Characteristics:

Low (less than 20 dB)

3. Operating Mode:

Pulse

CW

Dual Mode (pulse or CW)

4. Method of Focusing:

PPM (periodic permanent magnet)

Solenoid (single electromagnet)

Coupled Cavity

5. Terms associated with TWT operation:

a. **Gain Compression:** Change in amplification a device provides as it operates near saturation.

b. **Overdrive:** TWT is operating beyond the point of saturation.

c. **Saturation Gain:** Ratio of output power to input power when the device is being driven at maximum output.

d. **Serrodyne:** Linear translation of the phase of a signal on the helix of a TWT by a linear sawtooth waveform that enables the TWT to operate as a single sideband frequency translator.

e. **Small Signal Gain:** Ratio of output power to input power when the TWT is operating linearly.

Two-signal jamming (also called straddle jamming) - Jamming whereby two signals are transmitted on two RF frequencies slightly separated. Effective against certain types of radar where receiver bandwidth is narrow enough to defeat noise jamming.

Ultra high frequency (UHF) - Frequencies from 300 to 3,000 MHz.

Unit prefixes - Prefixes used to indicate scientific units:

<u>Multiple</u>	<u>Prefix</u>	<u>Symbol</u>
10^{12}	tera	T
10^9	giga	G
10^6	mega	M
10^3	kilo	k
10^2	hecto	h
10^1	deka	da
10^{-1}	deci	d
10^{-2}	centi	c
10^{-3}	milli	m
10^{-6}	micro	μ
10^{-9}	nano	n
10^{-12}	pico	p
10^{-15}	femto	f
10^{-18}	atto	a

Unmodulated CW jamming - The transmission of a high power carrier frequency that causes an overload effect to occur in the radar receiver. Used against bandpass radars that have a limited tuning capability. Unmodulated CW jamming can be identified by a blackening of the scope background (no video present) in a wedge-shaped sector, or by a solid brightening of a wedge or sector, normally exceeding one bandwidth.

Uplink - The missile guidance signal that passes command guidance intelligence from the site to the missile.

Velocity gate pull-off (VGPO) - Method of capturing the velocity gate of a Doppler radar and moving it away from the skin echo. Similar to the RGPO, but used against Doppler radar systems. The target Doppler frequency, which is amplified and retransmitted, is shifted in frequency to provide an apparent rate change or Doppler shift.

Very high frequency (VHF) - Frequencies from 30 to 300 MHz.

Very low frequency (VLF) - Frequencies from 3 to 30 kHz.

Video frequency –

1. A band of frequencies extending from approximately 100 Hz to several MHz.
2. The frequency of the voltage resulting from television scanning. Range from zero to 4 MHz or more.

Warning receiver - A receiver with the primary function of warning the user that his unit is being illuminated by an electromagnetic signal of interest.

Wideband constant false alarm rate receiver (WB-1) - Used against individual or combinations of rapidly swept FM-CW, noise, or CW jamming. This mode has nonlinear limiting and gives poor resolution of overlapping targets.

Window –

1. Strips of frequency-cut metal foil, wire, or bars that may be dropped from aircraft or missiles, or expelled from shells or rockets as a radar countermeasure. A confusion reflector.
2. A passive radar deception or confusion device; usually consisting of some metallic structure, designed in size and shape to effectively reflect impinging signals, to simulate a true target.
3. British name for chaff.

Wobulation - A periodic and usually slow variation of a parameter (such as frequency, amplitude, or period) about a central value. A low frequency modulation of a jamming carrier that appears on a radar display as a “wobbling” target. This effect is an undesired result of an angle deception or time-varying barrage technique.

Wooden round - An ordnance round (shell, missile, etc.) requiring no maintenance or preparation time prior to loading for firing.

ANNEX B

EC-RELATED ABBREVIATIONS AND ACRONYMS

A

AAA	Antiaircraft artillery
AAM	Air-to-air missile
AAS	ARM alarm sensor
AC	Alternating current
ACET	Automatic cancellation of extended targets
ACQ	Acquisition
AC&W	Aircraft control and warning
ADA	Air defense artillery
ADF	Automatic direction finding
ADL	Automatic data link
AEW	Airborne early warning
AF	Air Force/audio frequency
AFB	Air Force Base
AFC	Automatic frequency control
AFRES	Air Force Reserves
AGC	Automatic gain control
AGI	Auxiliary general intelligence (ship)
AGL	Above ground level
AGM	Air-to-ground missile
AI	Airborne interceptor
AJ	Anti-jamming
AM	Amplitude modulation
AM-CW	Amplitude modulated continuous wave
AMOP	Amplitude modulation on pulse
AMP	Amplifier
AMRAAM	Advanced medium range air-to-air missile
AMTI	Airborne moving target indicator
ANG	Air National Guard
ANL	Automatic noise limiting
AOA	Angle of arrival/angle of attack
AOJ	Angle-on-jam
ARM	Antiradiation missile
ASK	Amplitude shift keying
ASM	Air-to-surface missile
ASR	Air surveillance radar
ASW	Anti-submarine warfare
ATC	Air traffic control
ATD	Automatic target detector
ATR	Antenna, transmit receive

ATV	Automatic threshold variation
AVNL	Automatic video noise leveling
AVP	Adaptive video processing
AWACS	Airborne warning and control system
AZ	Azimuth

B

BBC	Beam-to-beam correlation
BCC	Battery control center
BFO	Beat frequency oscillator
BIT	Built-in test
BMEWS	Ballistic Missile Early Warning System
BN	Barrage noise
BSE	Boresight error
BTE	Battery terminal equipment
BW	Bandwidth
BWO	Backward wave oscillator

C

C	Degree centigrade
C²	Command and control
C³	Command, control, and communications
C²W	Command and control warfare
CAP	Combat air patrol
CAS	Close air support
CE	Clutter eliminator
CEP	Circular error probable
CFAR	Constant false alarm rate
CIJ	Close-in jamming
CIU	Control indicator unit
CM	Countermeasures
COHO	Coherent oscillator
COMINT	Communications intelligence
COMSEC	Communication security
CONSCAN	Conical scan
COSRO	Conical scan-on-receive-only
CPAC	Coded pulse anti-clutter
CP	Circular polarization
CRT	Cathode ray tube
CSG	Clean strobe generator
CSLC	Coherent sidelobe canceler
CV	Coincident video
CVR	Crystal video receiver

CW	Continuous wave
CWAR	Continuous wave acquisition radar
CWI	Continuous wave illuminator

D

dB	Decibel
dBm	Decibels relative to 1 milliwatt
dBw	Decibels relative to 1 watt
DBB	Detector back bias
DBF	Digital beam forming
DC	Direct current
DET	Detector
DF	Direction finder/Dicke fix
DINA	Direct amplified noise
DIFM	Digital instantaneous frequency measurement
DME	Distance measuring equipment
DOA	Direction of arrival/dead on arrival
DOF	Degrees of freedom
DPI	Detected pulse interference
DR	Dynamic range/dead reckoning
DRFM	Digital radio frequency memory
DSB	Double sideband
DTM	Data transfer module

E

EA	Electronic attack
EC	Electronic combat
ECCM	Electronic counter-countermeasures
ECM	Electronic countermeasures
ECP	Electronic combat pilot
EDAC	Error detection and correction
EHF	Extremely high frequency
EID	Emitter identification (table)
EL	Elevation
ELINT	Electronic intelligence
ELSCAN	Elevation scan
EMCON	Emission control
EMI	Electromagnetic interference
EMP	Electromagnetic pulse
EO	Electro-optical
EOB	Electronic order of battle
EP	Electronic protection
ER	Electronic reconnaissance

ERP	Effective radiated power
ES	Electronic warfare support
EVIL	Evaluated vs. integrated log
EW	Electronic warfare
EWO	Electronic warfare officer
EWWS	Electronic warfare warning set

F

F	Degrees Fahrenheit
FA	Frequency agility
FC	Fire control
FAAR	Forward area alerting radar
FAGC	Fast automatic gain control
FCR	Fire control radar
FCS	Fire control system
FEBA	Forward edge of the battle area
FFO	Fixed frequency oscillator
FFT	Fast Fourier transform
FLIR	Forward looking infrared
FM	Frequency modulation
FM-CW	Frequency modulation continuous wave pulsed
FMOP	Frequency modulation on pulse
FOJ	Fuse-on-jam
FOR	Field of regard
FOTD	Fiber optic towed decoy
FOV	Field of view
FRESCAN	Frequency scanning
FS	Frequency sector
FSK	Frequency shift keying
ft	Feet
FTC	Fast time constant

G

G	Antenna gain/acceleration due to gravity
GAS	Ground aided seeker
GCA	Ground controlled approach
GCI	Ground controlled intercept
GEN	Generator
GHz	Gigahertz

H

HARM	High-speed antiradiation missile
HAWK	Homing all-the-way killer
HBW	Horizontal beam width
HF	High frequency/height finder
HFDF	High frequency direction finding
HIPIR	High-power illuminator radar
HOJ	Home-on-jam
HOT	Home-on-target
HQ	Headquarters
HUMINT	Human intelligence
HVP	High video pass
HVPS	High voltage power supply
Hz	Hertz

I

I	Improved
IADS	Integrated air defense system
IAGC	Instantaneous automatic gain control
ICD	Imitative communications deception
ICW	Interrupted continual wave
IF	Intermediate frequency
IFC	Instantaneous frequency correlator
IFF	Identification, friend or foe
IPM	Instantaneous position memory
IR	Infrared
IRCM	Infrared countermeasures

J

JAT	Jam angle track
JAVA	Jamming amplitude versus azimuth
JCS	Joint Chiefs of Staff
JLT	Jammer look-through
J/S	Jamming-to-signal (ratio)
JTIDS	Joint Tactical Information Distribution System

K

K	Degrees Kelvin
kHz	Kilohertz
km	Kilometer

KO	Keyed oscillation
kV	Kilovolts
kW	Kilowatts

L

LASER	Light amplification by stimulated emission of radiation
LET	Leading-edge tracker
LF	Low frequency
LFMOP	Linear frequency modulation on pulse (chirp)
LIN	Linear
LIN-LOG	Linear-logarithmic amplifier
LLLTV	Low light level television
LO	Local oscillator
LOG	Logarithmic
LOG-FTC	Logarithmic receiver with fast time constant
LORO	Lobe-on-receive-only
LOS	Line of sight
LPI	Low probability of intercept
LT	Listening time
LVA	Log video amplifier

M

M	Meter
MALD	Miniature air launched decoy
MASER	Microwave amplification by stimulated emission of radiation
MANPADS	Manportable air defense system
MAWS	Missile approach warning system
MBB	Main beam blanking
MCG	Midcourse guidance
MCD	Manipulative communications deception
MDT	Mission data type
MDF	Mission data file
MDG	Mission data generator
MF	Medium frequency
MFAR	Multifunction array radar
MG	Missile guidance
MGC	Manual gain control
MHz	Megahertz
MIC	Microwave integrated circuit
MIJI	Meaconing, Intrusion, Jamming, and Interference
MLC	Mainlobe cancellation
MLV	Memory loader verifier
mm	Millimeter

MMIC	Monolithic microwave integrated circuit
MMW	Millimeter wave
MOE	Measure of Effectiveness
MOPA	Master oscillator power amplifier
msec	Millisecond
MTD	Moving target detector
MTI	Moving target indicator
MUX	Multiplexer
MW	Megawatts

N

NBFM	Narrowband frequency modulation
NBL	Narrowband limiting
NBLP	Narrowband long pulse
nm	Nautical mile
NLP	Narrowband long pulse
NOTAM	Notice to airmen
NSPS	Nonsynchronous pulse suppression

O

OPF	Operational flight program
OOB	Order of battle
OOK	On-off keying
OOK CW	Interrupted CW
OPDEC	Operational deception
OPSEC	Operational security
OTH	Over-the-horizon

P

PAM	Pulse amplitude modulation
PAR	Pulse acquisition radar/precision approach radar
PAT	Passive angle track
PC	Pulse compression
PCM	Pulse code modulation
PD	Pulse Doppler/pulse duration (same as PW)
PDM	Pulse duration modulation
PENAIDS	Penetration aids
PFM	Pulse frequency modulation
PFN	Pulse-forming network
PHOTOINT	Photographic intelligence
PIE	Pulse interference elimination

PISAB	Pulse interference suppression and blanking
PLD	Pulse length discrimination (same as PWD)
PM	Phase modulation
PN	Pseudo noise
PPC	Pulse-to-pulse correlation
PPI	Plan position indicator
PPM	Pulse position modulation
PPS	Pulses per second
PRF	Pulse repetition frequency
PRI	Pulse repetition interval
PRT	Pulse recurrence time
PSK	Phase shift keying
PW	Pulse width
PWD	Pulse width discrimination
PWM	Pulse width modulation

R

RADAR	Radio detection and ranging
RAGM	Range angle gate memory
RAM	Radar absorbing material/repeater amplitude modulation
RANRAP	Random range program
RC	Resolution cell
RCS	Radar cross section
RDF	Radio direction finding
RF	Radio frequency
RFD	Radio frequency discriminator
RFI	Radio frequency interference
RGM	Range gate memory
RGPI	Range gate pull in
RGPO	Range gate pull off
RHAW	Radar homing and warning
RHI	Range height indicator
ROB	Radar order of battle
ROR	Range only radar
R/P	Receiver/processor
RPD	Random pulse discrimination
RPJ	Random pulse jamming
RPM	Revolutions per minute
RPS	Random pulse suppression
RPV	Remotely piloted vehicle
RSBN	Radio short-range beacon for navigation
RT	Recovery time
R/T	Receiver/transmitter
RWR	Radar warning receiver

S

SAM	Surface-to-air missile
SAR	Synthetic aperture radar
SASE	Semi-automatic support equipment
SATCOM	Satellite communications
SBB	Single beam blanking
SCV	Sub-clutter visibility
SEAD	Suppression of enemy air defenses
sec	Seconds
SHF	Super high frequency
SIF	Selective identification feature
SIGINT	Signals intelligence
S/J	Signal-to-jamming (ratio)
SLAR	Side-looking airborne radar
SLB	Sidelobe blanking
SLC	Sidelobe cancellation
SLS	Sidelobe suppression
S/N	Signal-to-noise (ratio)
SOJ	Stand-off jamming
SORO	Scan-on-receive-only
SRM	Swept rectangular modulation
SS	Swept-spot
SSB	Single sideband
SSN	Swept-spot noise/social security number
SRW	Swept rectangular wave
SSW	Swept square wave
STALO	Stable local oscillator
STC	Sensitivity time control
SWC	Scan with compensation

T

TA	Target acquisition
TACAN	Tactical air navigation
TALD	Tactical air launched decoy
TBM	Track break modulation
TDD	Target detection device
TDOA	Time difference of arrival
TEL	Transporter-erector-launcher
TELAR	Transporter-erector-launcher and radar
TET	Trailing edge tracker
TEWS	Tactical electronic warfare system
TFR	Terrain following radar
TGT	Target
TJS	Tactical jamming system

TOA	Time of arrival
TOF	Time of flight
TOJ	Track-on-jam
TPL	Transmitter pulse lengthening
TPS	Transmitter pulse shaping
TTR	Target tracking radar
TV	Television
TVM	Track-via-missile
TWS	Track-while-scan
TWT	Traveling wave tube

U

UHF	Ultra high frequency
µsec	Microseconds

V

VCO	Voltage controlled oscillator
VDL	Video data link
VGPO	Velocity gate pull off
VHF	Very high frequency
VHSIC	Very high speed integrate circuit
VINT	Video integration
VLf	Very low frequency
VSrw	VGPO with swept rectangular wave
VSWR	Voltage standing-wave ratio

W

W	Watts
WBFM	Wideband frequency modulation
WBL	Wideband limiting
WPB	Wide pulse blanking
WSP	Wideband short pulse

LIST OF REFERENCES

1. Adamy, D., "Seduction Decoys", *Journal of Electronic Defense*, Vol. 20, No 7, pp. 58-59, July, 1997.
2. Adamy, D., "EW 101", *Journal of Electronic Defense*, Vol. 21, No 1, pp. 14-19, January, 1998.
3. Bar-Shalom, Y., *Multitarget-Multisensor Tracking: Advanced Applications*, Artec House, Inc., Norwood, MA, 1990.
4. Chrzanowshi, E. J., *Active Radar Electronic Countermeasures*, Artec House, Inc., Norwood, MA, 1990.
5. Det 8, Training Support Squadron, *Radar Concepts for Electronic Warfare*, January 1997.
6. Deyerle, C. M., "Advanced Infrared Missile Counter-Countermeasures", *Journal of Electronic Defense*, Vol. 17, No 1, pp. 47-70, January, 1994.
7. Lothes, R. N. et al., "Radar Vulnerability to Jamming", Artec House, Inc., Norwood, MA, 1990.
8. Maksimov, M. V. et al., *Radar Anti-jamming Techniques*, Artec House, Inc., Norwood, MA, 1979.
9. Neri, F., *Introduction to Electronic Defense Systems*, Artec House, Inc., Norwood, MA, 1990.
10. Schleher, D. C., *Introduction to Electronic Warfare*, Artec House, Inc., Norwood, MA, 1986.
11. Skolnik, M. L., *Introduction to Radar Systems*, McGraw-Hill, Inc., New York, NY, 1980.
12. Stimson, G. W., *Introduction to Airborne Radar*, 2nd Edition, SciTech Publishing, Inc., Mendham, NJ, 1998.
13. USAF Air Warfare Center, *Radar, ECM and ECCM Fundamentals*, January 1992.

14. **Wiegand, R. J., *Radar Electronic Countermeasures System Design*, Artec House, Inc., Norwood, MA, 1991.**
15. **Wiley, R. G., *Electronic Intelligence: The Interception of Radar Signals*, Artec House, Inc., Norwood, MA, 1985.**
16. **4513 ATTG/INW, *Advanced Radar Principles for Electronic Combat*, 15 April 1991.**
17. **4513 ATTG/INW, *Basic Radar for Electronic Warfare*, 1 April 1990.**
18. **4513 ATTG/INW, *Principles of Chaff and Flares*, 15 April 1991.**